

# Inspire | Create

Exterior Door Collection



1978

WELCOME



ALL WEATHER  
AT HOME™

# Welcome to All Weather at Home.

On behalf of the entire team, we're thrilled to have you as part of the All Weather family. At first glance, we're a window, door, and glass company. But what we build goes far beyond the products we make. We bring people together and brighten the spaces that frame lives, homes, and communities—because that's what truly matters.

For over 45 years, this belief has shaped everything we do. Our story is one of steady progress, grounded in the knowledge that the road to success is always under construction. Every project we take on is a chance to build something lasting—for our customers, partners, and communities.

Whether you're building a family's dream home, partnering with a team you can count on to strengthen your business, or renovating with care, we're here to make it seamless. Thank you for trusting us to be part of your journey.

Let's get building—together.

  
**Jilene Lakevold**  
co-CEO

  
**Colin Wiebe**  
co-CEO



At All Weather at Home, it's always been about more than just products—our core focus is the people behind them and the relationships we build. Every project is a partnership, where we work hand-in-hand with you to make your vision a reality. Our product lines are easy to navigate, our catalogues are designed to inspire, and our team is here to help you make confident choices that meet your needs, vision, and style.

We're more than a product provider; we're a partner, helping you create a home that's truly yours.

## Over four decades of giving

We're committed to positively impacting lives and communities across Canada and proudly give back in four key areas: strengthening families, providing shelter, supporting education and health and wellness. Over the years this has included charitable giving, partnerships, employee volunteerism and supporting families in need, but one thing never changes – we show up for the moments that matter.





## Proudly Canadian

Since 1978, we've been dedicated to crafting Canadian-made windows and doors that can stand up to the country's unique climate. Nearly five decades later, All Weather at Home has grown to become one of Canada's largest window and door manufacturers.

Our 261,000 square-foot manufacturing facility in Edmonton, Alberta, produces a full range of award-winning, energy-efficient, and weather-resistant products that frame peoples' lives. From keeping the cold out in the winter to saving energy and reducing environmental impact year-round, every product is crafted with care, as if it were for our own homes

Our products include many industry firsts and award-winning designs, in addition to meeting the stringent performance requirements of ENERGY STAR® and North American Fenestration Standards (NAFS). We've received several accolades from ENERGY STAR® over the years, including the Special Recognition Award in 2023 and 2024, and have been acknowledged as one of Canada's Best Managed Companies 15 years in a row.



Platinum member



1978 Harry Buhler and Gord Wiebe receive their first order from Stuart Ford.









# Be inspired. **Get creative.**

## Your dream door starts here.

We understand the thought and care that go into choosing a door. It's more than just an entryway—it's a statement about your home and a reflection of your style. That's why we've designed this collection to make finding the perfect door an effortless and inspiring experience. With quality you can trust, your only focus is finding the one that feels right for you.

To make the process even easier, our catalogue is split into two sections: Inspire and Create.

**Inspire** is where your vision begins. Explore door materials, decorative glass styles, and timeless designs to spark ideas and narrow down the options that best suit your style. Each page is crafted to help you imagine the possibilities, guiding you toward the perfect match.

Once your inspiration takes shape, turn to **Create** for the details. Here you'll find the technical information needed to bring your door to life, including measurements, options, and hardware finishes. It's a simple, intuitive way to move from idea to reality.

Whether you're dreaming or designing, we've got you covered every step of the way.

Be inspired. Get creative.

# Inspire



**VISTAGRANDE®** flush-glazed smooth fibreglass doors **36**  
**NAPLES®** glass **78** fir woodgrain textured fibreglass door **40**





## 6 Inspire

- 8 New & Trending Door Highlights
- 26 Choosing a Door
- 30 Barrington® Sierra®
- 32 Contemporary Cherry
- 34 Rustic Mahogany
- 36 VistaGrande®
- 38 Craftsman Smooth
- 40 Textured Fibreglass
- 42 Smooth Fibreglass
- 44 Steel
- 46 Decorative Glass A-Z

## 94 Create

- 96 Operating Styles, Handing & Swing
- 98 Fire Rated Door System
- 100 NAFS & ENERGY STAR®
- 101 Entry Door System
- 102 Multilock Hardware
- 103 Grilles & SDL
- 104 Brickmould, Hinges & Striker Plates
- 105 Door Slab & Frame Finishes
- 106 Style Matrix A-Z
- 121 Slab Sizing
- 124 Frame & Rough Opening Sizes
- 126 Measuring Your Door
- 127 Door Planner
- 128 Notes
- 130 Door Glass Size Code & Panel Legend
- 131 Index

# New & trending **door** **highlights.**

First  
impressions  
matter.

Explore our curated collection of new and trending door designs—where modern style meets timeless elegance. A thoughtfully designed door does more than frame your entryway; it defines the aesthetic of your entire home. From sleek lines and bold finishes, to intricate glass designs and solid panels, today's contemporary doors set a fresh standard for style and sophistication.

Discover how the right door can create a powerful first impression while reflecting your home's unique character and your individual personality.







2 PANEL SHAKER 8'0" smooth fibreglass door 42



## Shake things up.

Available in smooth and fir grain textured fibreglass, our shaker doors are designed with today's home styles in mind. Pair with complementary interior doors and cabinets for a coordinated modern look throughout your home.

1 PANEL SHAKER fir woodgrain textured fibreglass door 40





2 PANEL SHAKER smooth fibreglass door 42

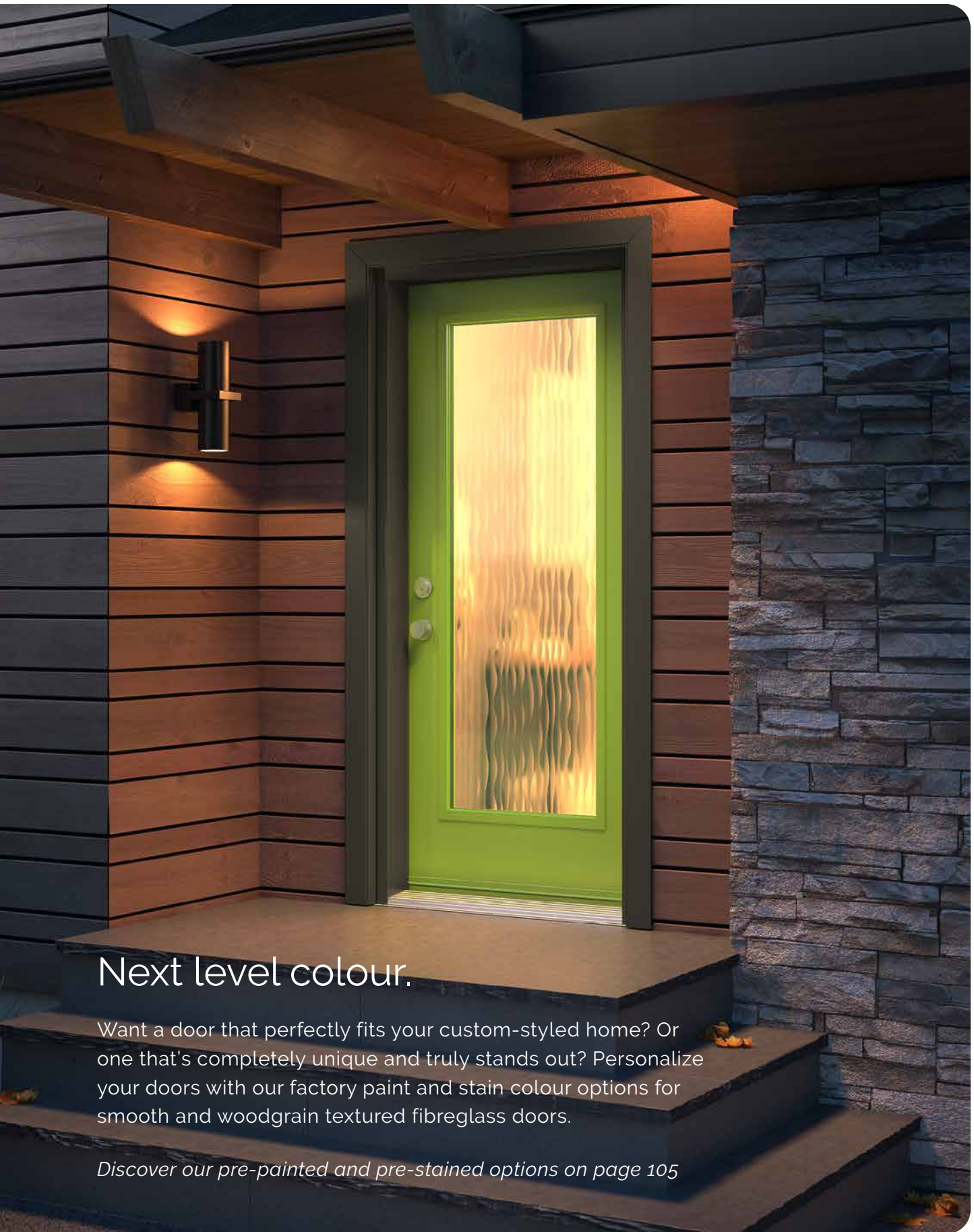

## Next level colour.

Want a door that perfectly fits your custom-styled home? Or one that's completely unique and truly stands out? Personalize your doors with our factory paint and stain colour options for smooth and woodgrain textured fibreglass doors.

*Discover our pre-painted and pre-stained options on page 105*

FLUID glass 64 smooth fibreglass door 42 pre-finished in lime green





**CONTEMPORARY CHERRY C601** cherry woodgrain textured fibreglass door with stainless steel lines 32 pre-finished in raven stain

Photos shown throughout this catalogue are for illustrative purposes only. This includes all displayed hardware, colours, finishes, and configurations, which may differ in availability and/or appearance on the final product. All doors come unfinished and do not include lockset/handle hardware unless otherwise specified.



# Exquisite textures.

Inspired by everything from flowing water to tufted fabrics, textured glass draws the eye and evokes intrigue. It allows increased, filtered light while offering various levels of privacy.

**SOFT** glass 64 smooth fiberglass door 42





ZENITH glass 93 smooth fibreglass door 42 pre-finished in blue, full opaque glass sidelites & transom



# Bring on the light.

Chic lines and flowing, natural light add an intriguing and welcoming atmosphere to any space in your home. With our wide selection of textured and decorative door glass, you can make your home exactly what it should be - yours.

OPAL glass 80 steel door 44





CELESTE glass 54 steel door 44

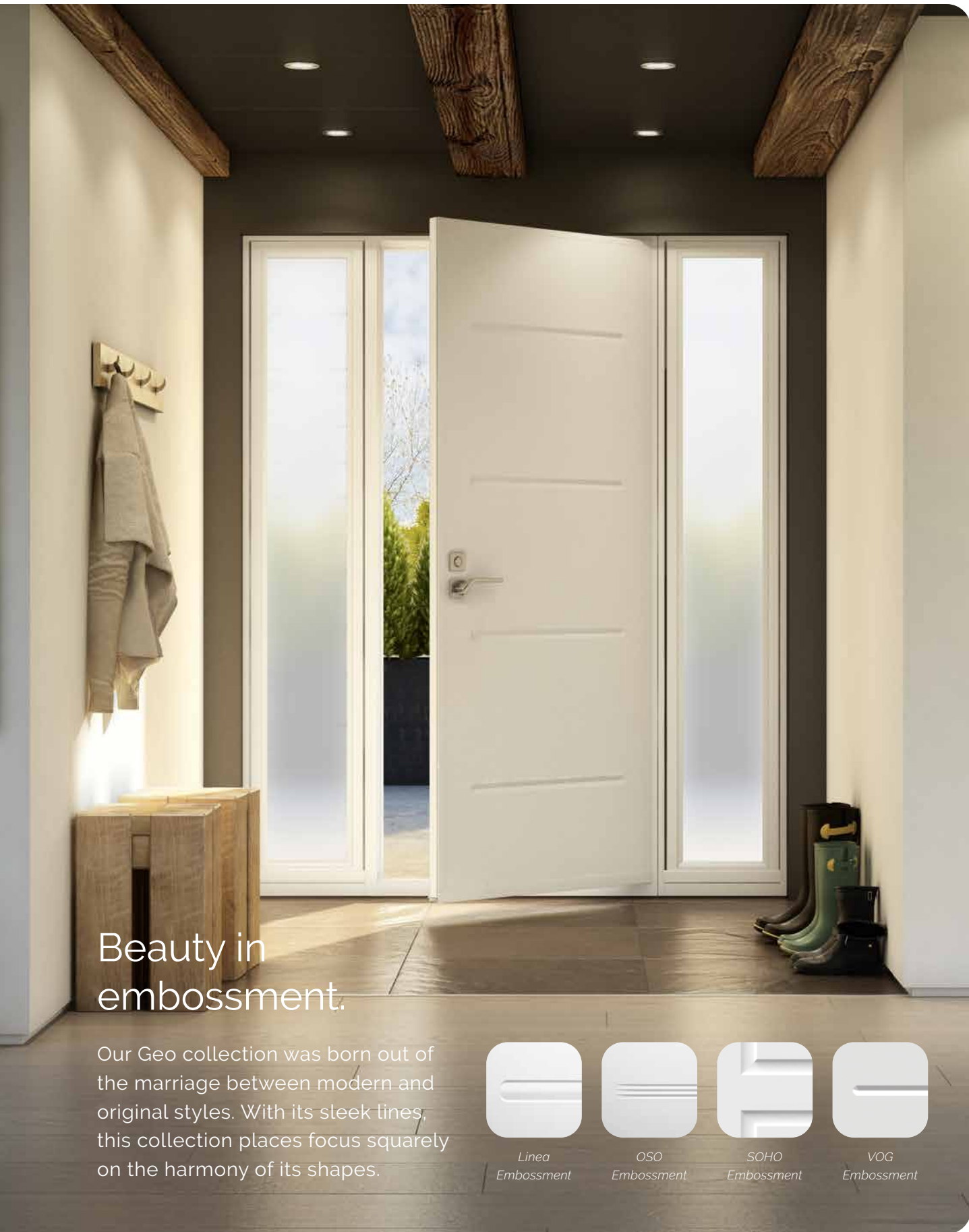

## Beauty in embossment.

Our Geo collection was born out of the marriage between modern and original styles. With its sleek lines, this collection places focus squarely on the harmony of its shapes.



*Linea*  
Embossment



*OSO*  
Embossment



*SOHO*  
Embossment



*VOG*  
Embossment

**VOG** steel door 44 full opaque glass sidelites





**OSO** steel door 44 full clear glass sidelite

Photos shown throughout this catalogue are for illustrative purposes only. This includes all displayed hardware, colours, finishes, and configurations, which may differ in availability and/or appearance on the final product. All doors come unfinished and do not include lockset/handle hardware unless otherwise specified.



SOHO steel doors 44 full obscure glass sidelite and transom





LINEA fluid glass 64 steel door 44



# Mid-century flair.

With an emphasis on minimalistic design and functionality, our mid-century modern series radiates personality and is the ultimate statement for the design-conscious homeowner.

*Discover mid-century modern on page 74.*





**MID-CENTURY MODERN** clear glass 74 smooth fibreglass door 42

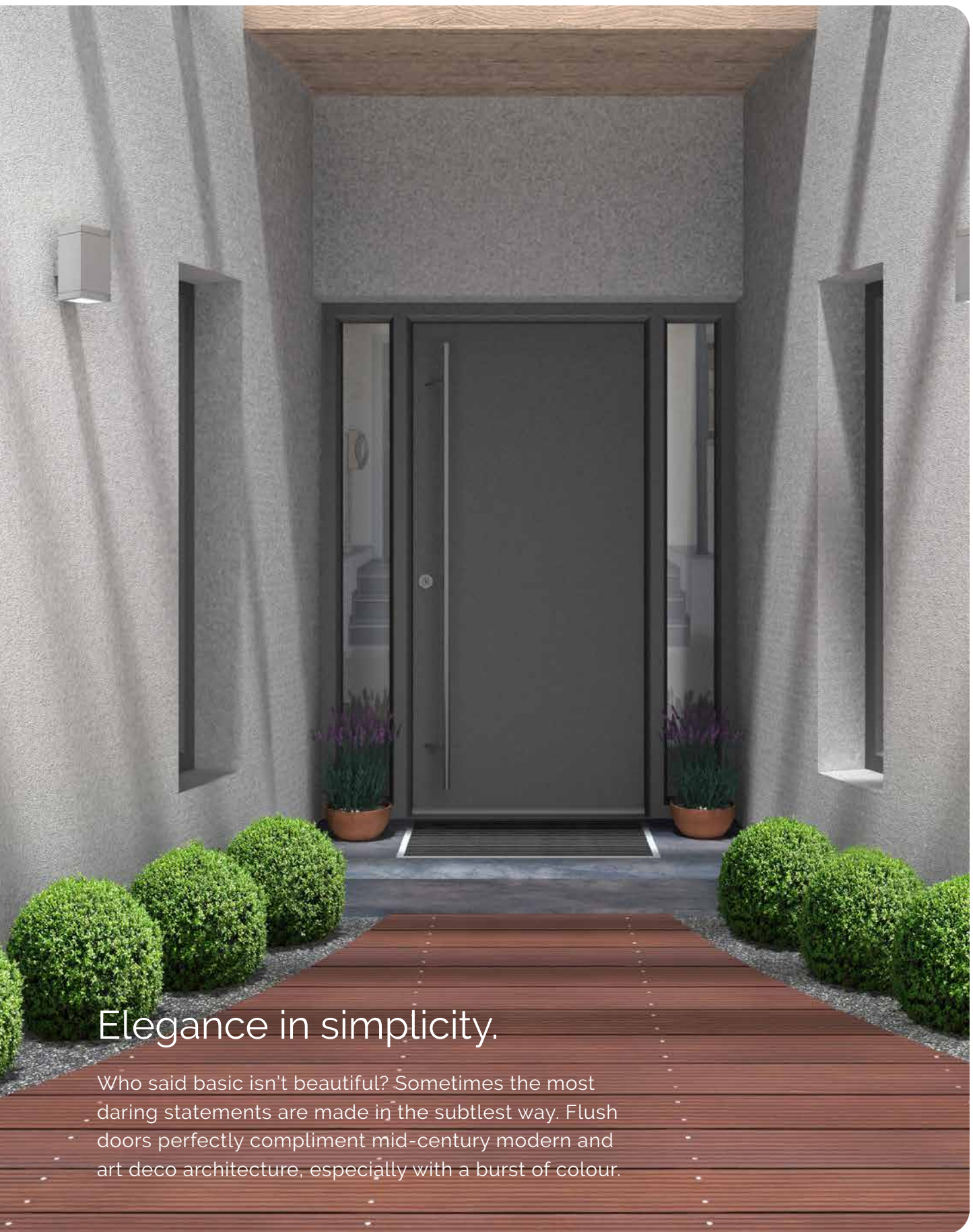

# Elegance in simplicity.

Who said basic isn't beautiful? Sometimes the most daring statements are made in the subtlest way. Flush doors perfectly compliment mid-century modern and art deco architecture, especially with a burst of colour.

**FLUSH** smooth fibreglass door 42 full clear glass sidelites pre-finished in slate





**FLUSH** smooth fibreglass door 42 full clear glass sidelite & transom

# Choosing a door **inspired by you.**

Beyond the functionality, the type of door you choose can say a lot about who you are. Welcoming. Bold. Charming. These are just a few of the words that come to mind when thinking about the connection between door and homeowner.

Choosing the right doors for your home shouldn't feel overwhelming. To help you choose the doors that deliver the appearance and performance you want, keep these following three simple steps in mind as you explore our catalogue.



## **1 Be inspired**

Let your personal style and vision guide you in selecting the perfect entry door.

Think about your own personality. Do you like to make a statement or do you prefer a subtle effect? Is your home's style more classic or contemporary? Do you have a specific colour scheme in mind?

We have many options so take your time to be inspired and discover your style.



## **2 Choose a material**

Doors are built with a variety of material and each material offers its own benefits and aesthetic appeal.

Choose from woodgrain-textured fibreglass that has the appearance of real wood, smooth fibreglass that can be painted any colour, or one of our prefinished steel skin doors for added security.

Be sure to consider the right material to meet your individual needs for you and your home.

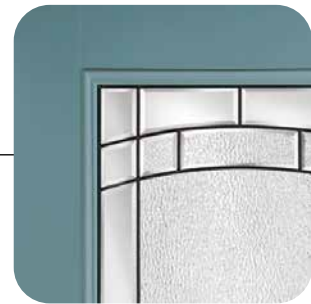

## **3 Accentuate**

This is when you can really begin to customize your door and bring your vision to life.

Choose from a variety of custom sidelites, designer transoms and decorative glass inserts while tying all the accents together by coordinating grille, casing and hardware colours.

Whatever the desired end product, these options can make the bold or subtle statement you're looking for.

## Barrington® Sierra® Mahogany Texture Fibreglass

Taking inspiration from the craftsman style, Sierra introduces elegantly embossed panels for a bold take on a traditional look.



\$\$\$\$



### AUTHENTIC EMBOSSING

Deep, defined embossing mimics that of traditional hand-crafted wood doors.



### MATCHING STILES

Real mahogany-capped, square edge stiles offer an authentic wood look.

Discover more on page **30**

## Contemporary Cherry Textured Fibreglass

Using NVD Technology, cherry grain doors achieve a wood grain texture that is indistinguishable from real wood.



\$\$\$\$



### STAINLESS STEEL EMBELLISHMENTS

Stainless steel strips are inlaid directly into the fibreglass skin.



### CONTEMPORARY CHERRY GRAIN

Cherry grain brings warmth and modern texture to any entry way.

Discover more on page **32**

## Contemporary Cherry Textured Fibreglass

Simple and pure in design, our contemporary cherry collection achieves bold, modern design with all the benefits of fibreglass.



\$\$\$



### GROOVED LINES

Gentle, recessed lines are engraved right into the fibreglass skin.

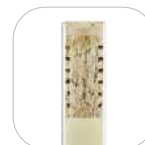

### OVERSIZED STILES

Oversized 4-1/8" LSL stiles give added strength and help prevent warping.

Discover more on page **32**



## Rustic Mahogany Textured Fibreglass

Our luxury textured fibreglass rustic doors add warmth to your home while accentuating personal style with a distinctly European feel.



\$\$\$



### AUTHENTIC EMBOSSING

*Deep, defined embossing mimics that of traditional hand-crafted wood doors.*



### LUXURY MAHOGANY WOOD GRAIN

*Detailed texture replicates real mahogany grain.*

*Discover more on page 34*

## VistaGrande® Fir Textured & Smooth Fibreglass

Instantly brighten and beautify any space with wider, factory-flush glazing - you can truly bring the outdoors in.



\$\$\$



### CUSTOM FACTORY FLUSH-GLAZING

*Offers a cleaner, more refined appearance and wider viewing area.*



### INTERNAL MINI BLINDS

*Maintenance-free internal mini blinds provide privacy without losing your view.*

*Discover more on page 36*

## Craftsman Smooth Fibreglass

With a pre-pigmented white skin, smooth craftsman doors are a beautiful, long-lasting alternative to steel entry doors.



\$\$\$



### HYDROSHIELD TECHNOLOGY™

*Smooth skin craftsman entry doors will not dent, rust or delaminate.*



### CUSTOM FACTORY FLUSH-GLAZING

*Offers a cleaner, more refined appearance for an authentic craftsman look.*

*Discover more on page 38*

## Textured Woodgrain Fibreglass

Featuring distinct architectural details, 3 authentic grain patterns, and endless customizable glass and panel combinations.



\$\$\$



### MAHOGANY, OAK & FIR WOODGRAIN

*Make a bold statement with variable-depth woodgrain patterns.*



### HIGH-DEFINITION PANEL PROFILE

*Detailed and well-defined panel profile adds architectural appeal.*

*Discover more on page 40*

## Smooth Fibreglass

With a smooth, paintable, low-maintenance fibreglass surface, these doors are sure to fit any architectural style.



\$\$\$



### HIGH-PERFORMANCE SMOOTH SURFACE

*Ideal for painting & will not rust or dent.*



### LIMITLESS CUSTOMIZATION

*From decorative glass to grilles and panels, the hardest part is deciding.*

*Discover more on page 42*

## Prefinished Steel

Boasting high-definition panel profiles and endless glass options, our steel doors offer the most in flexibility and security.



\$\$\$



### PREFINISHED WHITE OR BLACK

*High-quality factory applied white or black painted surface.<sup>1</sup>*



### ROT-RESISTANT BOTTOM RAIL

*High-quality composite bottom rail and wood-edge construction resists rot and corrosion.*

*Discover more on page 44*

<sup>1</sup> Door glass insert frames do not come prefinished and need to be painted to match the door. Black prefinished doors come with a black exterior only and are not available with door glass. The interior surface is prefinished in white only.



Be bold.

Who says you need glass to make a statement? Create dramatic intrigue with a solid panel Barrington® Sierra® fibreglass door. After all, simple is beautiful.

BARRINGTON® SIERRA® 2 panel plank



Be bold. Barrington® Sierra® doors are the pinnacle of woodgrain solid-panel doors. Featuring all the benefits of Barrington luxury fibreglass, this series will be sure to impress for years to come.

### **Authentic mahogany woodgrain texture**

The highly detailed mahogany grain adds sophistication & richness to any entrance.



*Barrington Sierra mahogany pre-finished in cedar stain*

### **Inspired rustic design**

Vertical planks and soft arches echo rustic flair and authentic craftsmanship.



*Barrington Sierra mahogany pre-finished in raven stain*

### **Matching wood stiles**

Real mahogany-capped, true square-edge stiles offer an authentic wood look.



*Barrington Sierra mahogany pre-finished in mahogany stain*

#### **PANEL STYLES**



Explore all available styles on page **119**

# Contemporary Cherry Designer Fibreglass



Not your  
ordinary cherry.

Our contemporary cherry grain doors combine the strength and durability of fibreglass with the elegance and style of today's modern designs.

**CONTEMPORARY CHERRY C501** textured fibreglass door with grooved lines



Simple and pure in design, our contemporary cherry collection achieves bold design through stainless steel embellishments or simple grooved lines. Made with high quality cherry grain textured fibreglass, this door adds warmth and texture to any entry way.

### **Stainless steel embellishments**

Stainless steel bars in the fibreglass surface create a bold, ultra-modern look.

### **Contemporary embossing**

Simple, symmetrical grooves bring a refined and fresh feel to any modern style.

### **Variable-depth cherry grain texture**

Cherry brings warmth with its well-defined texture, perfect for any modern architecture.



C605 - stainless steel lines



C528 - grooved lines



C536 - grooved lines



C604



C602

#### **STAINLESS STEEL LINE STYLES**

*Bold and strong, stainless steel strips are embellished right into the fibreglass surface, perfect for any modern style.*



#### **GROOVED LINE STYLES**

*Striking and refined, recessed grooved lines create a beautiful and refined style for the ultimate contemporary look.*

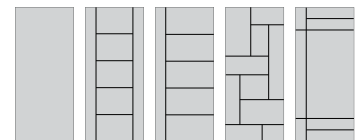

Explore all available styles on page **119**

Photos shown throughout this catalogue are for illustrative purposes only. This includes all displayed hardware, colours, finishes, and configurations, which may differ in availability and/or appearance on the final product. All doors come unfinished and do not include lockset/handle hardware unless otherwise specified.



# Rustic Mahogany Designer Fibreglass

Simply  
charming.

Inspired by the rural  
countryside, rustic  
mahogany echoes  
refined elegance.



**RUSTIC MAHOGANY** textured fibreglass 2 panel arch-top door

Our luxurious Rustic Mahogany textured fibreglass doors add warmth to your home while accentuating personal style with a distinctly European architectural feel. Channel old country charm with distressed, deep-grained mahogany texture.

### Variable-depth mahogany grain

Detailed texture replicates the look of real mahogany wood-grain for a truly rustic look.

### Authentic panel embossing

Deep, defined embossing mimics that of authentic hand-crafted wood doors.

### Dramatically wide

Rustic mahogany door slabs are available up to 42" wide on select styles.



1 panel plank



2 panel square-top plank



2 panel arch-top plank



1 panel arch-top plank



2 panel square-top

#### PANEL & PLANK STYLES

Rustic mahogany doors are available in several panel and plank designs to perfectly match your space and style.

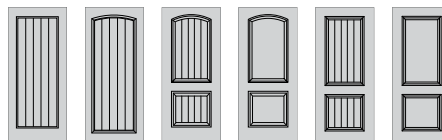

Explore all available styles on page 119



## Vista views.

Create breathtaking views with wide, factory flush-glazed glass, truly bringing the outdoors inside.

PEAR 926 full glass with 152 full sidelites



Instantly brighten any space with VistaGrande® flush-glazed doors. Available in a number of glass options, VistaGrande® doors offer a wider viewing area and cleaner appearance over traditional glass inserts.

### Smooth & fir grain textured fibreglass

Choose smooth fibreglass for a clean contemporary look, or fir grain for a craftsman feel.



*Fir grain fibreglass with 926 full clear glass & 3-1/2" SDL*

### Multiple glass & design options

Personalize your door with integrated mini blinds, textured glass or SDL options.



*Smooth fibreglass with 926 full internal blind*

### Flush-glazed glass

No insert frame means no unsightly screws and a maximized glass viewing area.

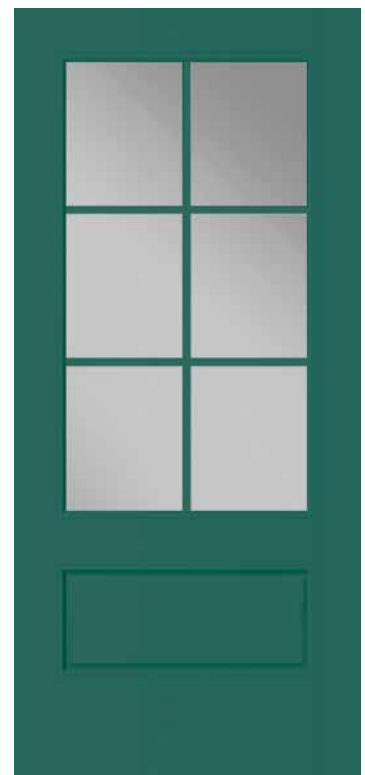

*Smooth fibreglass with 426 3/4 clear glass & 1-1/8" 6 lite SDL*

#### DOOR GLASS OPTIONS



*Clear*



*Chord®*



*Internal mini-blinds*



*Pear*



*Pearl®*

Explore all available styles on page **120**

# Craftsman Smooth Premium Fibreglass



## Craftsman redefined.

With a paintable, smooth finish and a high definition panel profile, the Craftsman door exudes contemporary style while also offering the low-maintenance upkeep of fibreglass.

**CLEAR 3 LITE SDL** 24-1/2" x 16-5/8" glass

Enjoy the rustic charm of Craftsman doors: mission-styled for an authentic wood look. Craftsman Smooth Skin fibreglass entry doors are a long-lasting alternative to steel and use an exclusive Hydroshield™ technology to resist dents, rust and delamination.

### Hydroshield™ technology

Proprietary skin technology resists the elements and everyday wear and tear.

### Pre-pigmented white fibreglass skin

Fully paintable white pre-pigmented fibreglass resists the appearance of scratches.

### Flush-glazed glass

No insert frame means no unsightly screws and a maximized glass viewing area.



Clear glass



Clear glass with 3 lite SDL

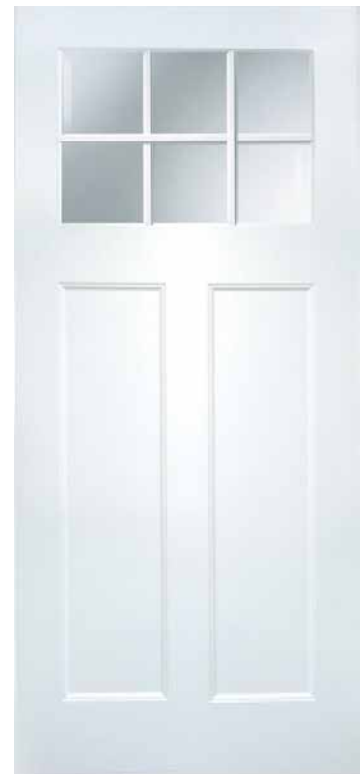

Clear glass with 6 lite SDL



Clear glass sidelite



Clear glass sidelite w/SDL

#### MATCHING SIDELITES

Compliment your door with an equally stunning, matching sidelites. Available with clear glass and optional SDL, adding sidelites will be sure to take your door to the next level of grandeur and sophistication.

Explore all available styles on page 118

Note: Craftsman Smooth series doors should not be combined with other craftsman-style doors offered by All Weather at Home due to their distinct panel and glass sizes.



# Textured Premium Fibreglass



Natural  
elegance.

With 3 distinct and detailed natural woodgrain textures to choose from, the only limit on style is your imagination.

CUZCO® 122 full glass in an oak textured slab with clear glass transom

Featuring textured premium woodgrain fibreglass in three grain types, our doors feature distinct architectural details, a reinforced lock area and thousands of customizable glass and panel combinations to choose from.

### Mahogany, oak & fir textured woodgrain

Make a stunning entrance with oak, fir or mahogany variable-depth woodgrain texture.

### Shaker panel profile

Craftsman style doors include recessed flat shaker panels for a real craftsman style.

### High-definition panel profile

Detailed panels create the authentic and inviting look of a real wood door.



Oak woodgrain texture with 106 1/2 Element® decorative glass



Fir woodgrain texture with 217 Focus decorative glass & optional dentil shelf



Mahogany woodgrain texture with 122 full Kordella® decorative glass



8 panel (mahogany)



6 panel (oak)

#### SOLID PANEL OPTIONS

Available in several solid panel styles in all three woodgrain textures that will seamlessly coordinate and compliment with any decor choice.

#### DOOR STYLES

With so many options to choose from, it would be impossible to list them all here! Visit the door style matrix in the CREATE section starting on page 106 to see all available door styles, sizes, and configurations in this series.

Explore all available styles on page 106

## Polished sophistication.

The smooth, paintable surface of our fibreglass doors suit any style. From ultra-modern to rural farmhouse, you'll be sure to find the perfect match for the perfect look.



Smooth fiberglass doors combine the elegance of wood with the low-maintenance of fiberglass. They feature high-definition panel profiles that add architectural interest and elegance. The smooth surface is paintable and will not rust or dent.

### Endless possibilities

Choose from hundreds of glass, panel, and sizing combinations.

### Shaker panel profile

Craftsman style doors include recessed flat shaker panels for a real craftsman style.

### High-definition panel profile

Detailed panels create the authentic and inviting look of a real wood door.

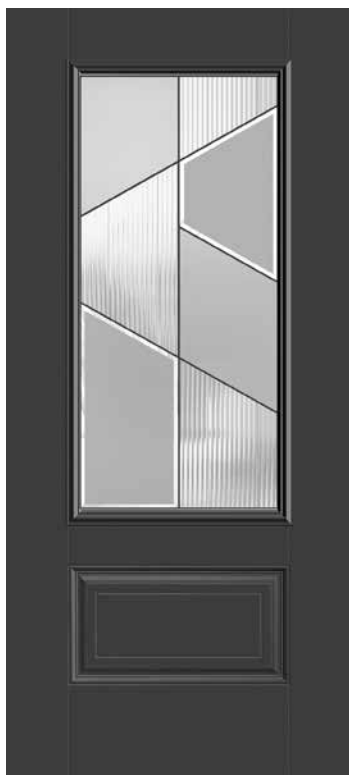

2 panel with 404 3/4 Bolero decorative glass



2 panel with 217 Frontier® decorative glass & optional dentil shelf



1 panel with 106 1/2 Channele decorative glass



2 panel plank arch top



2 panel square top

#### SOLID PANEL OPTIONS

Available in several solid panel styles that will seamlessly coordinate and compliment with any decor choice.

#### DOOR STYLES

With so many options to choose from, it would be impossible to list them all here! Visit the door style matrix in the CREATE section starting on page 106 to see all available door styles, sizes, and configurations in this series.

Explore all available styles on page 106



## Ultimate versatility.

From clean, modern lines to classic panels and decorative glass, steel doors give the widest range of door styles.

CHORD® 3 x 217 glass with full glass clear sidelite and transom

Our steel doors feature high-definition decorative panels that closely replicate those of traditional hand-crafted doors. Steel doors are also the ultimate choice for security. Best of all, they boast a durable and convenient prefinished white or black surface.

### High-definition panel profile

Detailed panels create a clean and inviting look while adding visual interest to your space.

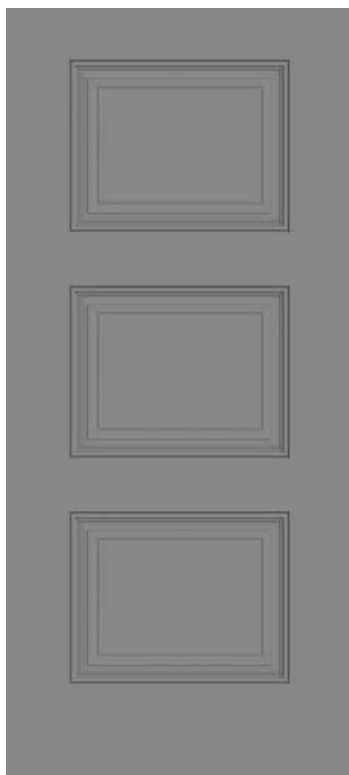

3 panel

### Modern embossments

Steel doors offer the latest in modern embossing and panel profiles.



VOG embossing

### Endless possibilities

Choose from hundreds of glass, panel, and sizing combinations.

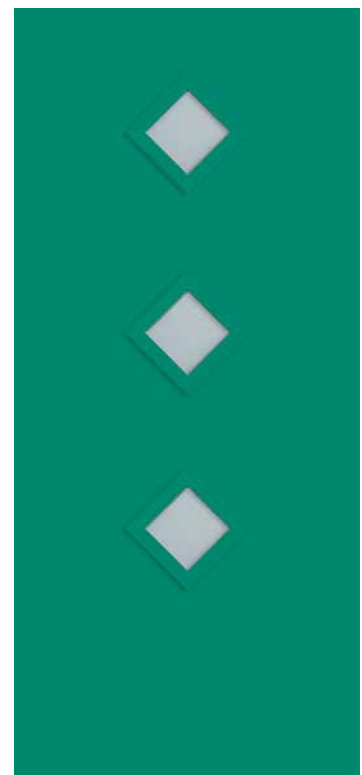

Mid-century modern with 808 sand blasted glass



Linea



OSO



SOHO



VOG

#### GEO COLLECTION

Available on our steel doors, the Geo collection perfectly blends modern and original styles with its sleek lines and bold shapes.

For size availability, see page 123.

#### DOOR STYLES

With so many options to choose from, it would be impossible to list them all here! Visit the door style matrix in the CREATE section starting on page 106 to see all available door styles, sizes, and configurations in this series.

Explore all available styles on page 106



# Decorative Glass



Elegance through glass.

Stunning designs and flowing, natural light add an intriguing and welcoming atmosphere to any space in your home. With our wide selection of textured and decorative door glass, you can make your home exactly what it should be - yours.

Accentuate the entrance of your home with decorative door glass. Available on steel, smooth, and textured fibreglass doors, our decorative glass is sure to brighten up your space, increase your privacy, and improve your home's overall curb appeal.

### Exquisite craftsmanship

Details like beveled glass and hand-applied caming ensure your door is made to impress.

### Bring on the light

Create bright open spaces with various glass textures, lines and patterns.

### Next-level style

From timeless elegance to ultra-modern chic, door glass elevates any style.

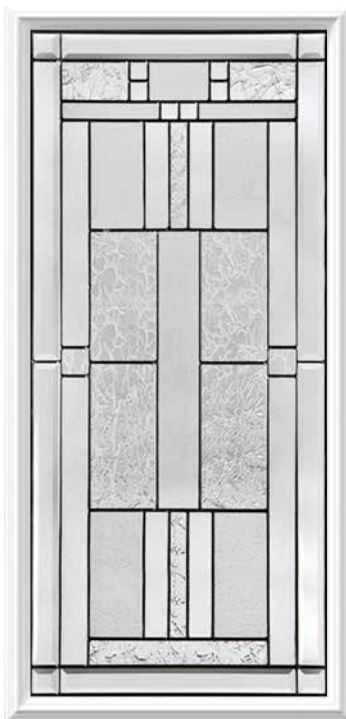

Cachet decorative glass



Verso decorative glass



Opal decorative glass



Cuzco 122  
full glass

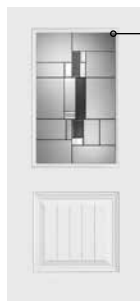

Cuzco 106  
1/2 glass

#### MULTIPLE GLASS SIZES

Almost every decorative glass style is available in multiple sizes. Look for the glass size icons on the following pages of a quick reference of which sizes are available in each glass style.

For complete glass size availability, see the Style Matrix starting on page 106.

Explore all available styles on page 106

# Adelaide

ADELAIDE 404 3/4 glass in a smooth fibreglass slab

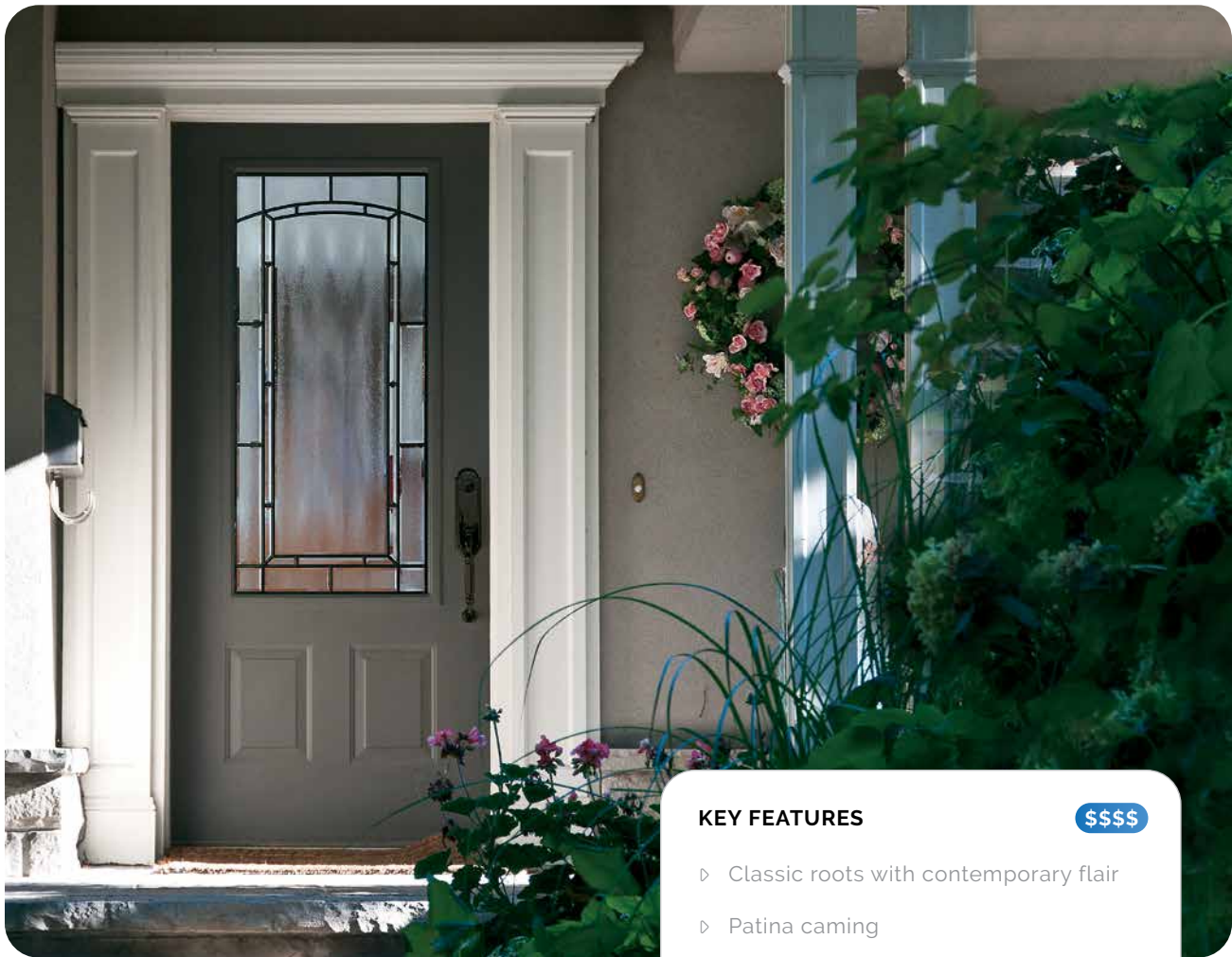

## KEY FEATURES

\$\$\$

- ▷ Classic roots with contemporary flair
- ▷ Patina caming
- ▷ High privacy rating

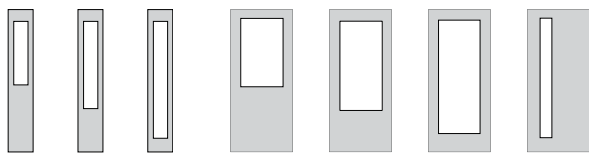

## PRIVACY



patina caming

sable beveled glass

clear beveled glass

Explore all available styles on page **106**



ALYS 122 full glass in a steel slab



## KEY FEATURES

\$\$

- ▷ Natural yet abstract design
- ▷ High privacy rating
- ▷ V-groove glass



sandblasted glass

v-groove lines

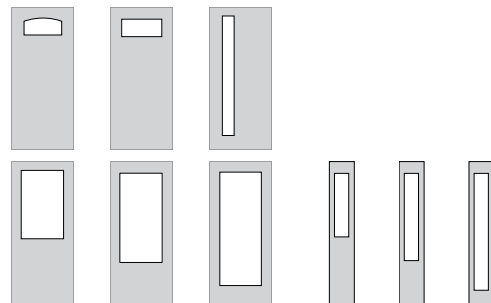

## PRIVACY



Explore all available styles on page 106

# Arima

ARIMA 404 3/4 glass in a smooth fibreglass slab with clear glass transom

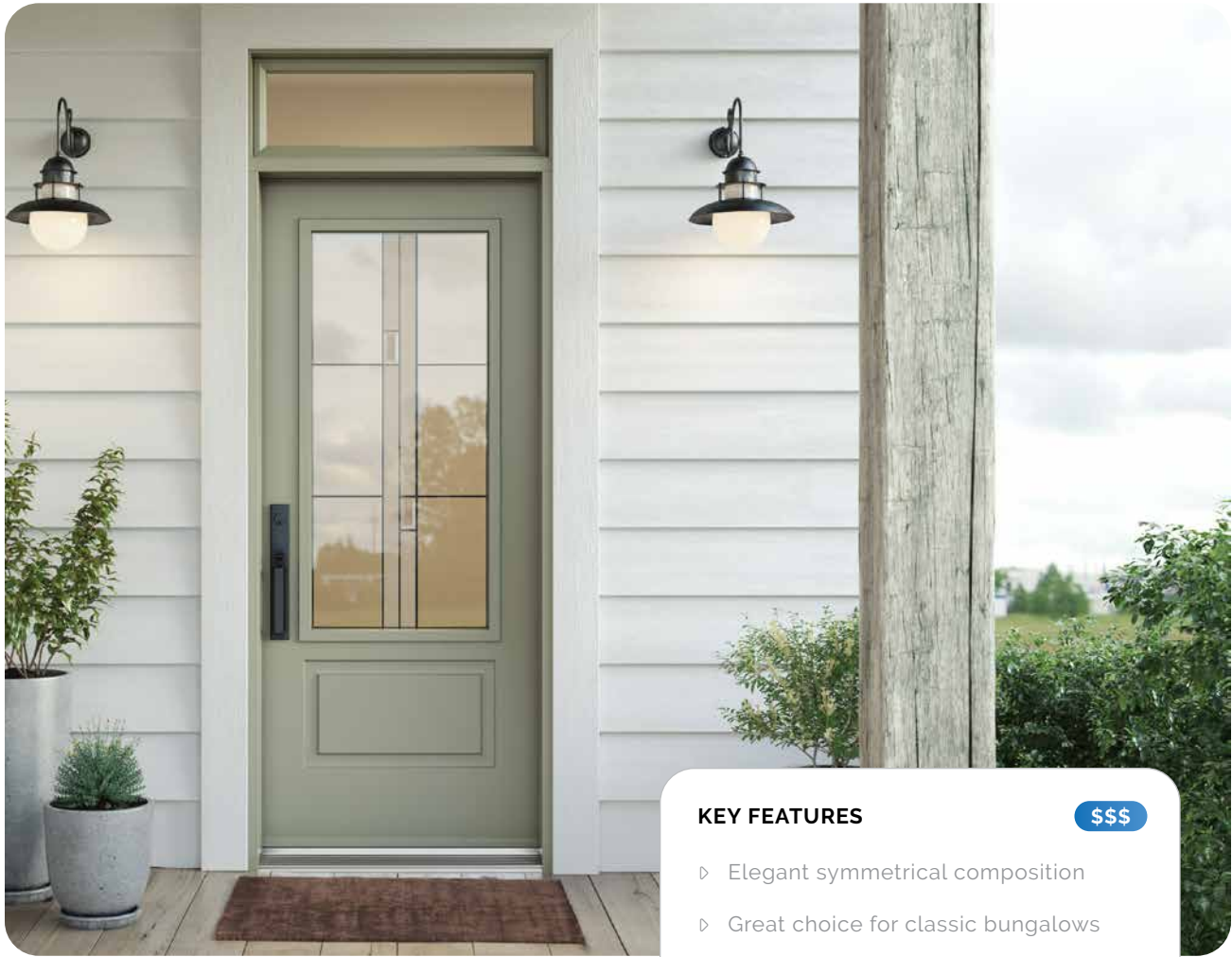

## KEY FEATURES

\$\$\$

- ▷ Elegant symmetrical composition
- ▷ Great choice for classic bungalows
- ▷ Patina caming

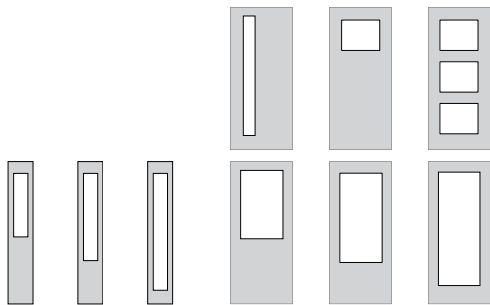

## PRIVACY



patina caming    satin finish glass    beveled clear glass    screen glass

Explore all available styles on page **106**

**AZUR** 122 full glass in a steel slab with full glass clear sidelites

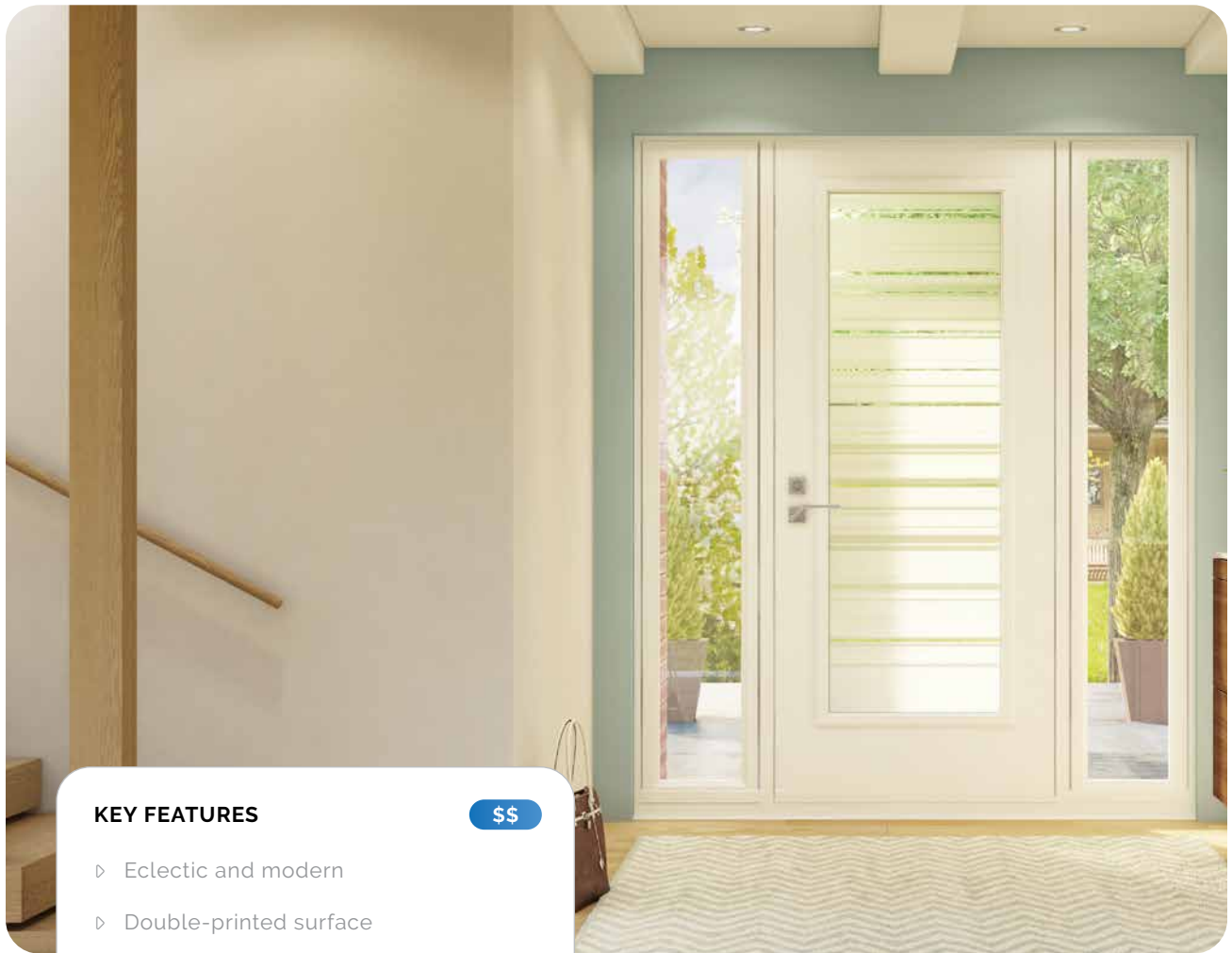

### KEY FEATURES



- ▷ Eclectic and modern
- ▷ Double-printed surface
- ▷ Sandblasted ink finish

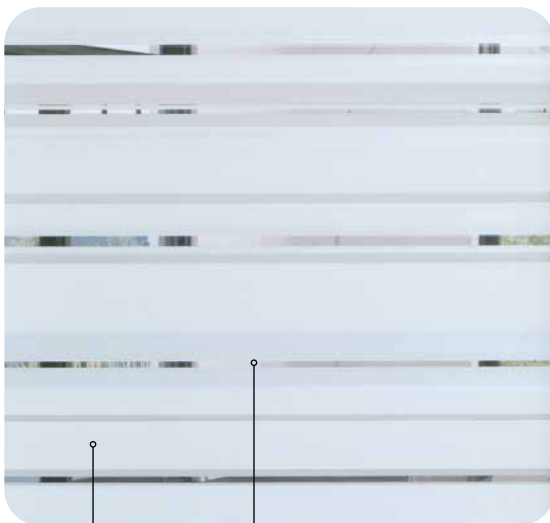

sandblasted  
ink finish

clear  
glass

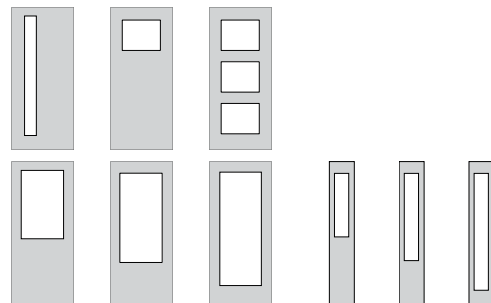

### PRIVACY



Explore all available styles on page **106**



# Bolero

BOLERO 122 full glass in a smooth fibreglass slab

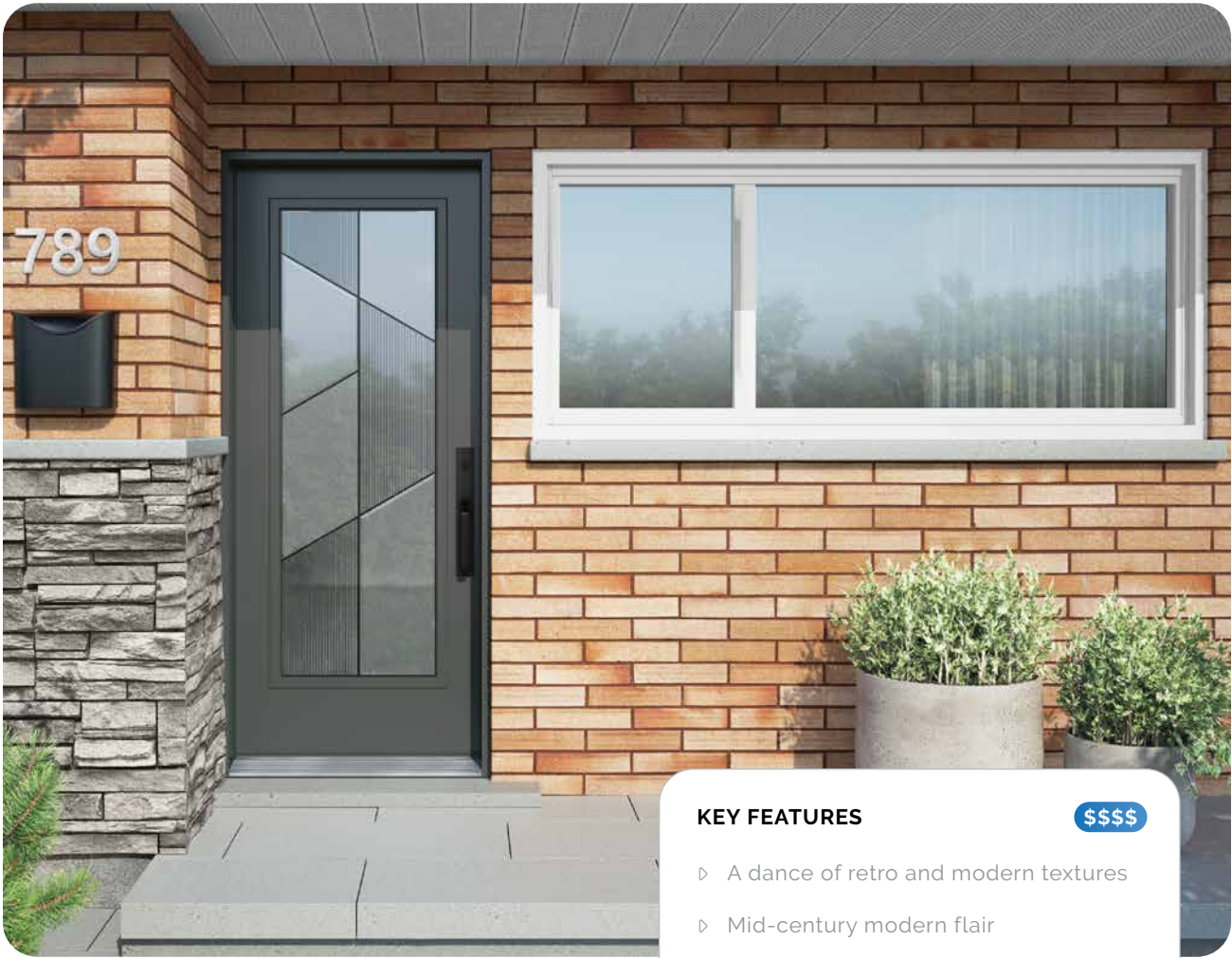

## KEY FEATURES

\$\$\$

- ▷ A dance of retro and modern textures
- ▷ Mid-century modern flair
- ▷ Patina caming

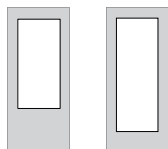

## PRIVACY

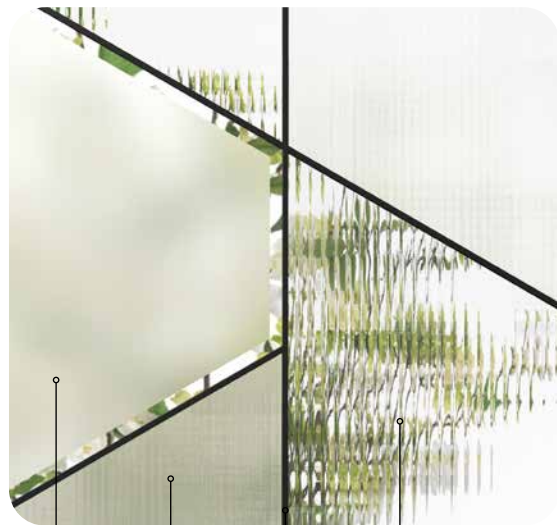

- satin finish beveled glass
- screen glass
- patina caming
- wide reed glass

Explore all available styles on page 106

CACHET 404.3/4 glass in a steel slab



## KEY FEATURES

\$\$\$

- ▷ Inspired by prairie style architecture
- ▷ Zinc or Patina caming
- ▷ Balanced and chic



- clear beveled glass
- zinc caming
- pinhead textured glass
- chord textured glass
- krinkle textured glass

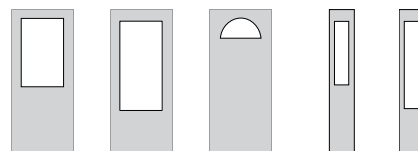

## PRIVACY



Explore all available styles on page 106

# Celeste

CELESTE 404 3/4 glass in a steel slab with 450 3/4 sidelite

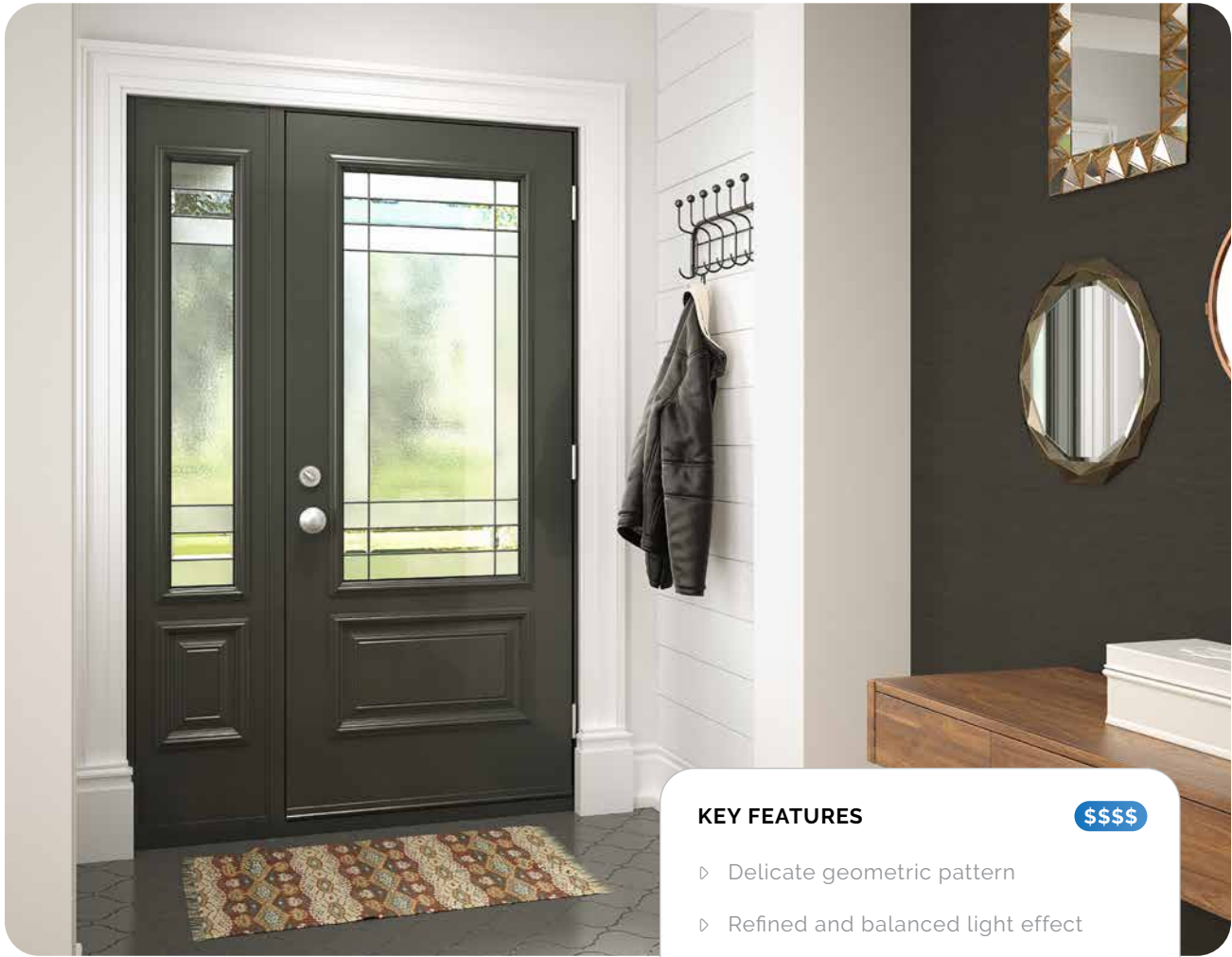

## KEY FEATURES

\$\$\$\$

- ▷ Delicate geometric pattern
- ▷ Refined and balanced light effect
- ▷ Patina caming

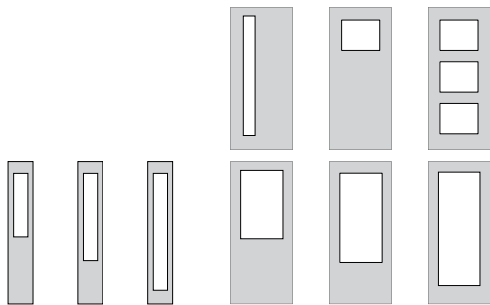

## PRIVACY



platinum caming  
clear beveled glass  
aqualite glass  
small hammered glass

Explore all available styles on page 106



# Chanelle

CHANELLE 404 3/4 glass in smooth fibreglass slabs

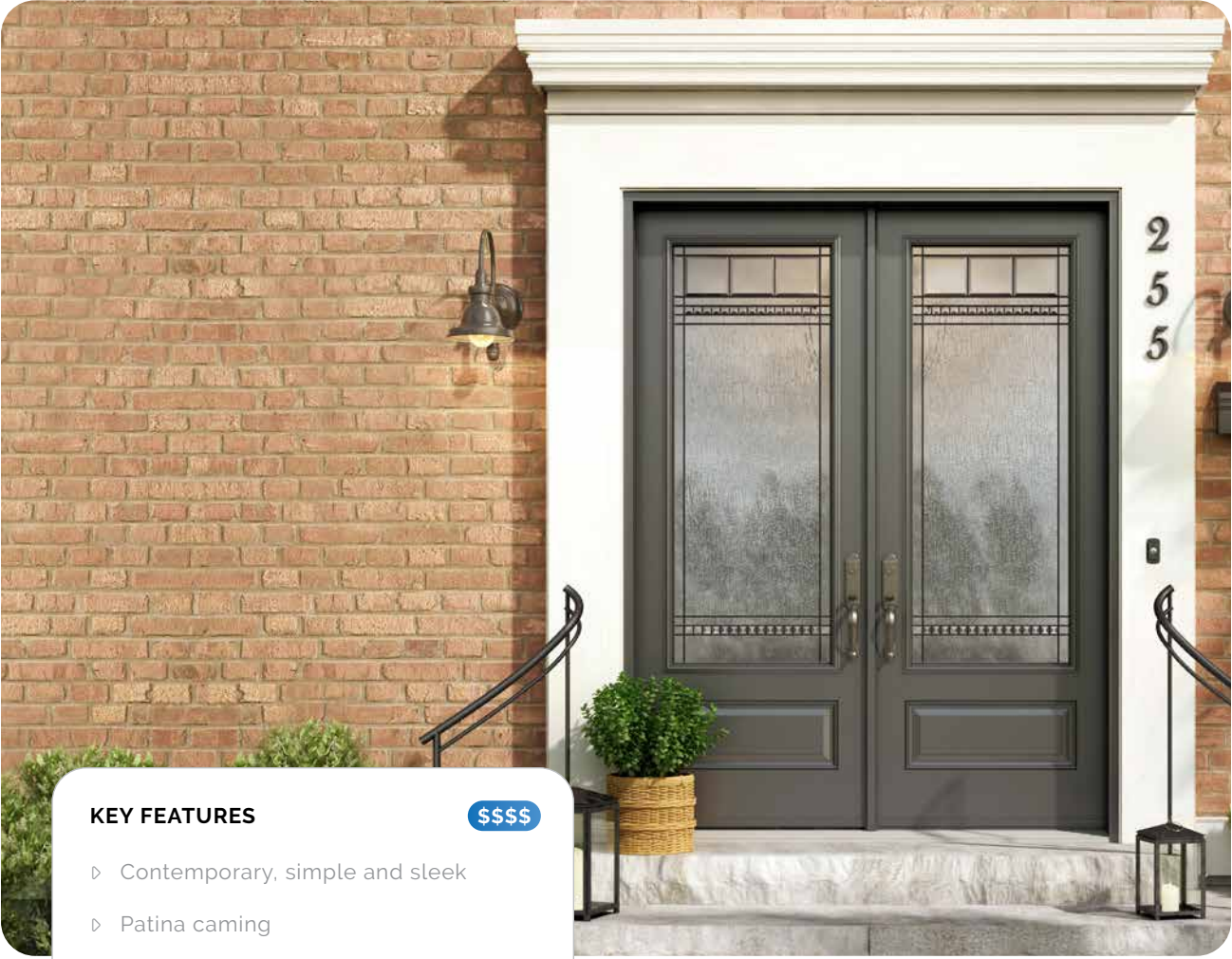

**KEY FEATURES** \$\$\$\$

- ▷ Contemporary, simple and sleek
- ▷ Patina caming
- ▷ Niagara and Chinchilla glass



chinchilla textured glass    niagara textured glass    clear beveled glass    patina caming

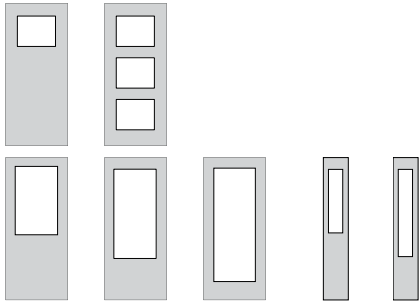

**PRIVACY**



Explore all available styles on page 106

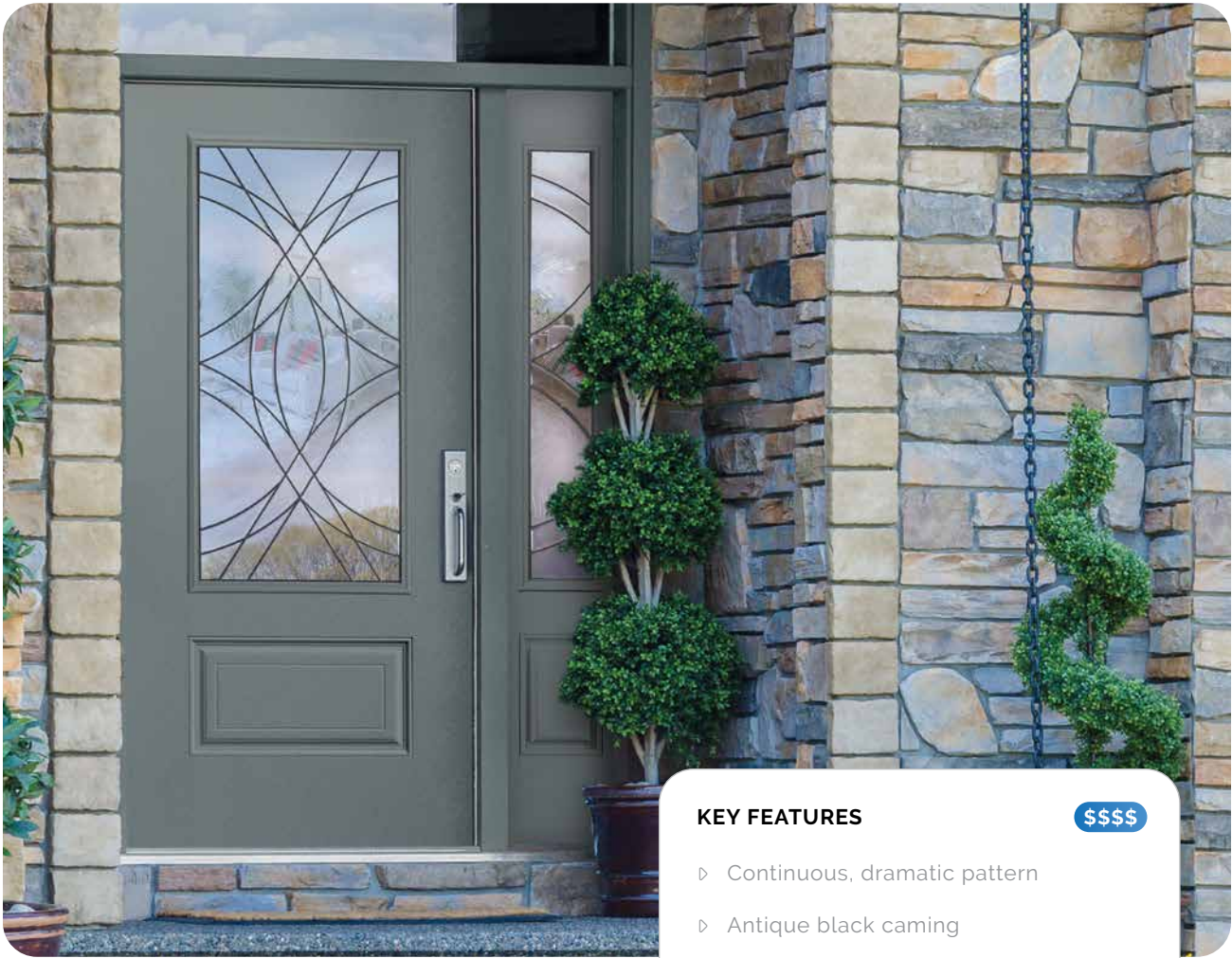

### KEY FEATURES

\$\$\$

- ▷ Continuous, dramatic pattern
- ▷ Antique black caming
- ▷ Clear Baroque glass

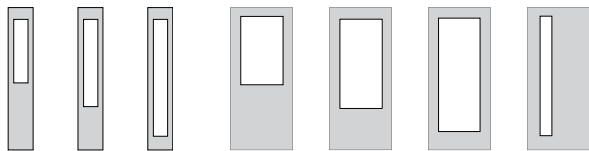

### PRIVACY



antique black caming

clear baroque glass

clear beveled glass

Explore all available styles on page 108



CHORD® 217 glass in steel slabs

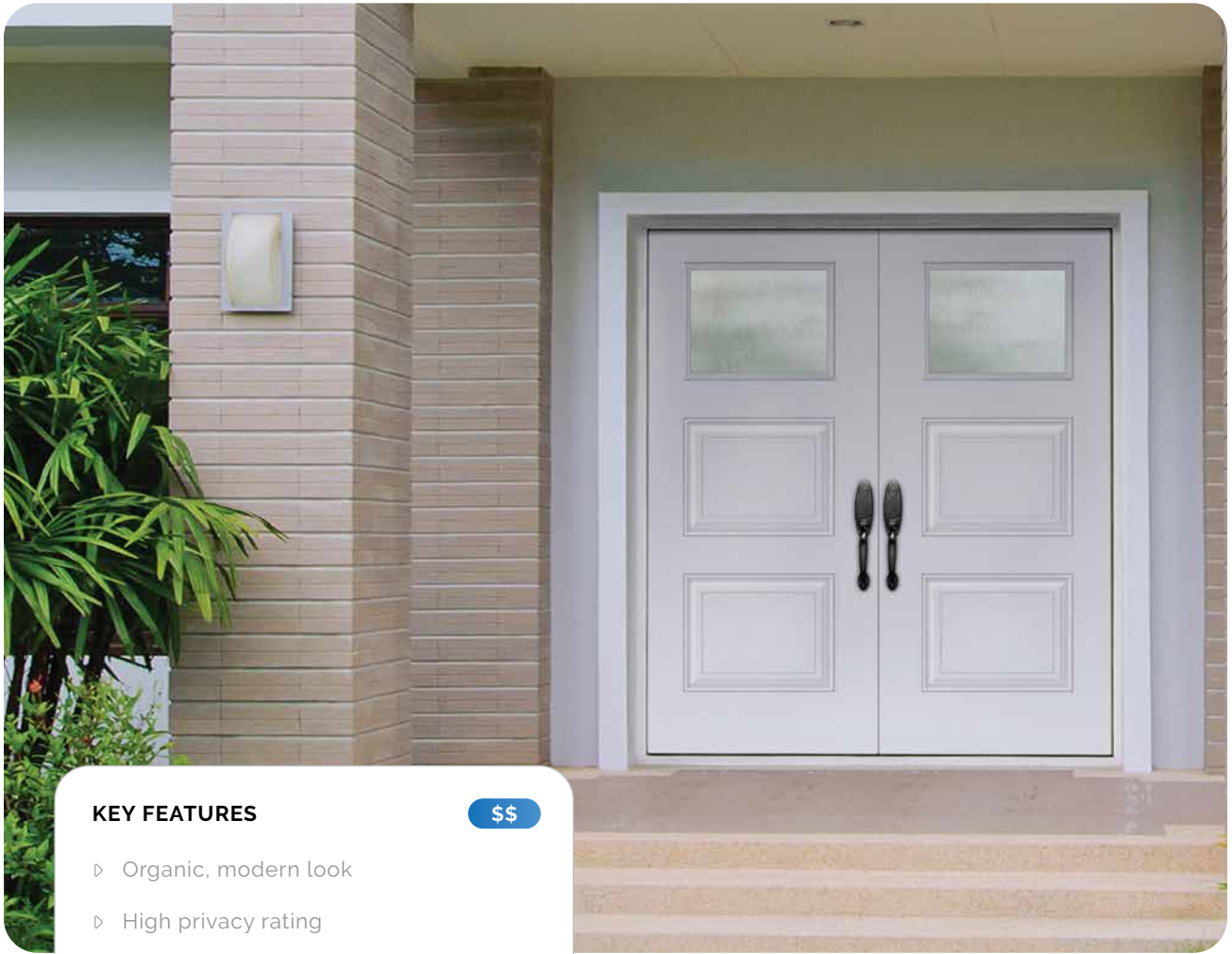

**KEY FEATURES**



- ▷ Organic, modern look
- ▷ High privacy rating
- ▷ Chord textured glass



chord textured glass

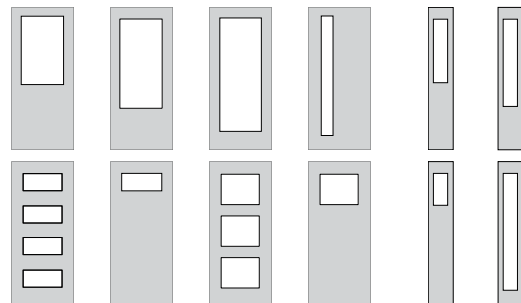

**PRIVACY**



Explore all available styles on page **108**



# Crosswalk

CROSSWALK 122 full glass in a smooth fibreglass slab with a 152 full sidelite

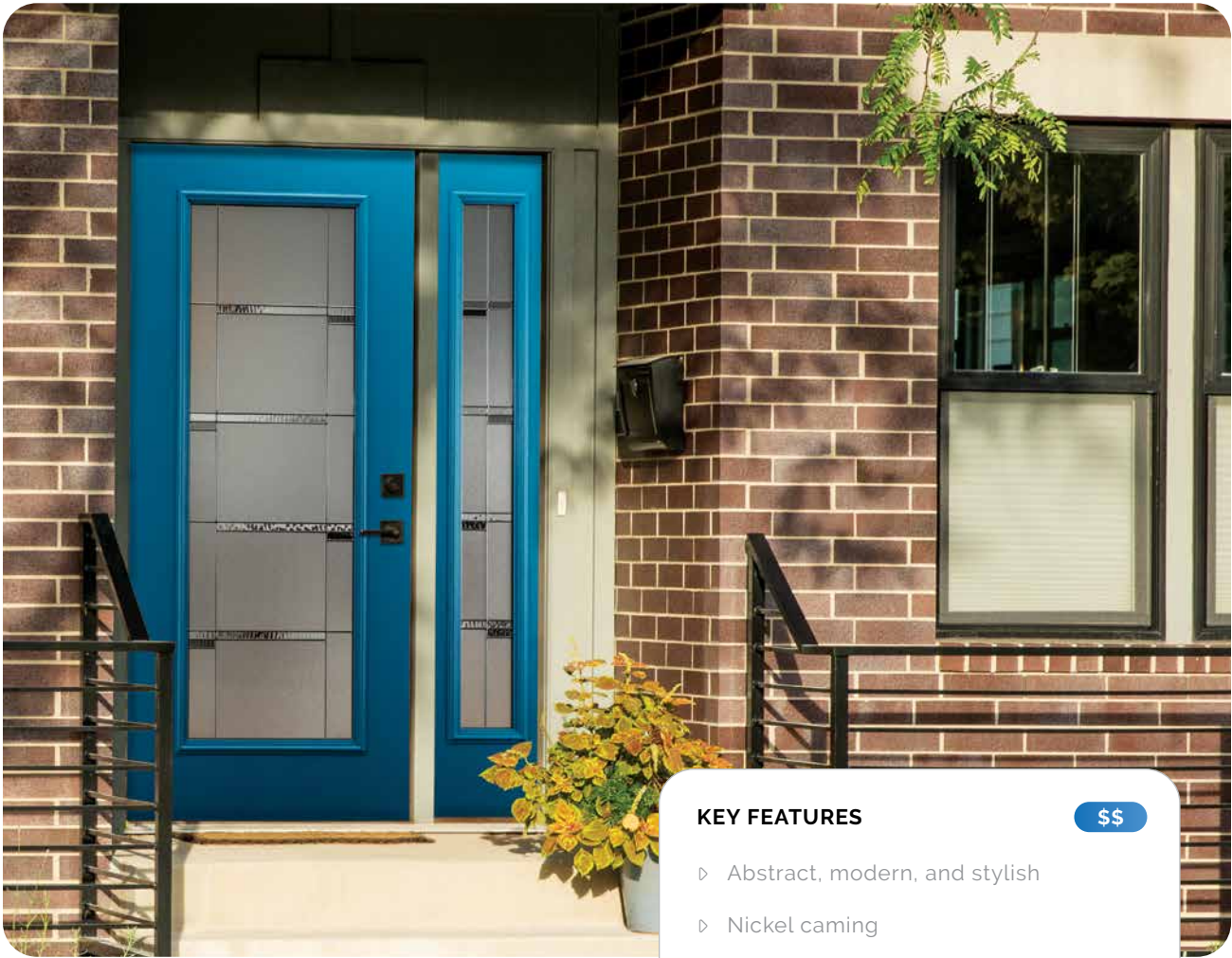

## KEY FEATURES

\$\$

- ▷ Abstract, modern, and stylish
- ▷ Nickel caming
- ▷ Pops of grey softwave glass

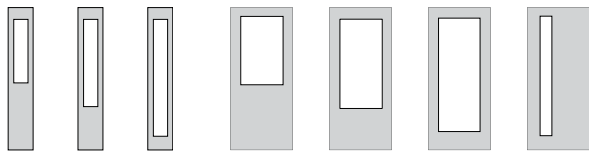

### PRIVACY



micro-iced granite glass

clear softwave glass

nickel caming

grey softwave glass

Explore all available styles on page **108**

CRUZ™ 122 full glass in a smooth fibreglass slab

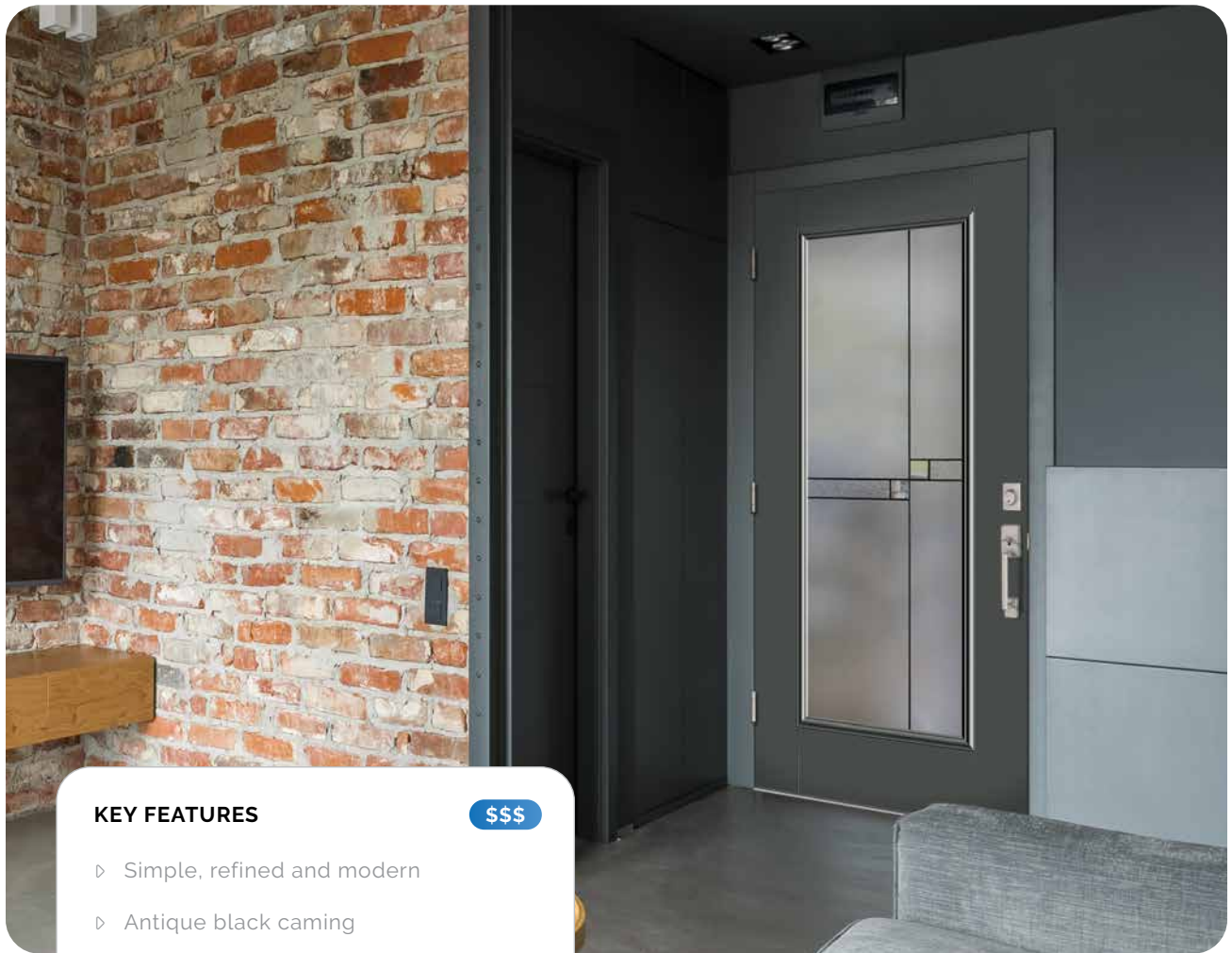

**KEY FEATURES** \$\$\$

- ▷ Simple, refined and modern
- ▷ Antique black caming
- ▷ Mistlite & Granite glass



mistlite glass    clear glass    granite glass    antique black caming

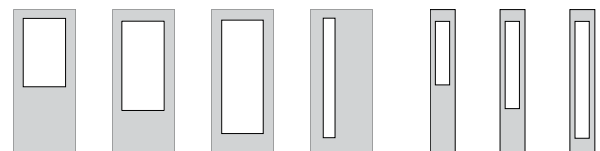

**PRIVACY**



Explore all available styles on page **108**

Photos shown throughout this catalogue are for illustrative purposes only. This includes all displayed hardware, colours, finishes, and configurations, which may differ in availability and/or appearance on the final product. All doors come unfinished and do not include lockset/handle hardware unless otherwise specified.



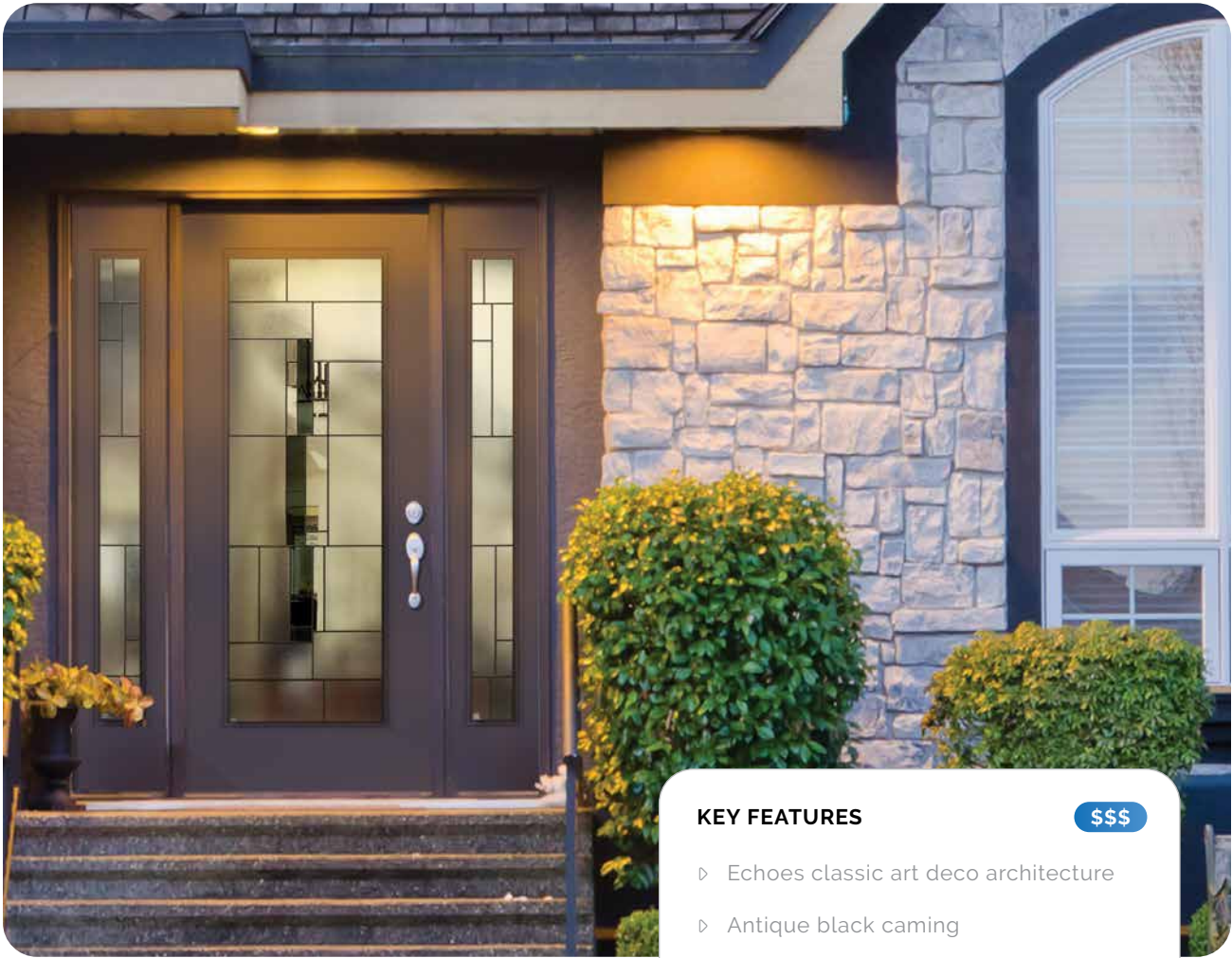

**KEY FEATURES**

\$\$\$

- ▷ Echoes classic art deco architecture
- ▷ Antique black caming
- ▷ Dark grey beveled glass

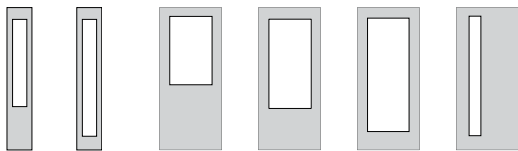

**PRIVACY**



mistlite glass, antique black caming, seedy glass, clear beveled glass, dark grey beveled glass, pear glass, dark grey glass

Explore all available styles on page 108



ELEMENT® 3 x 217 glass in a smooth fibreglass slab with a 152 full sidelite

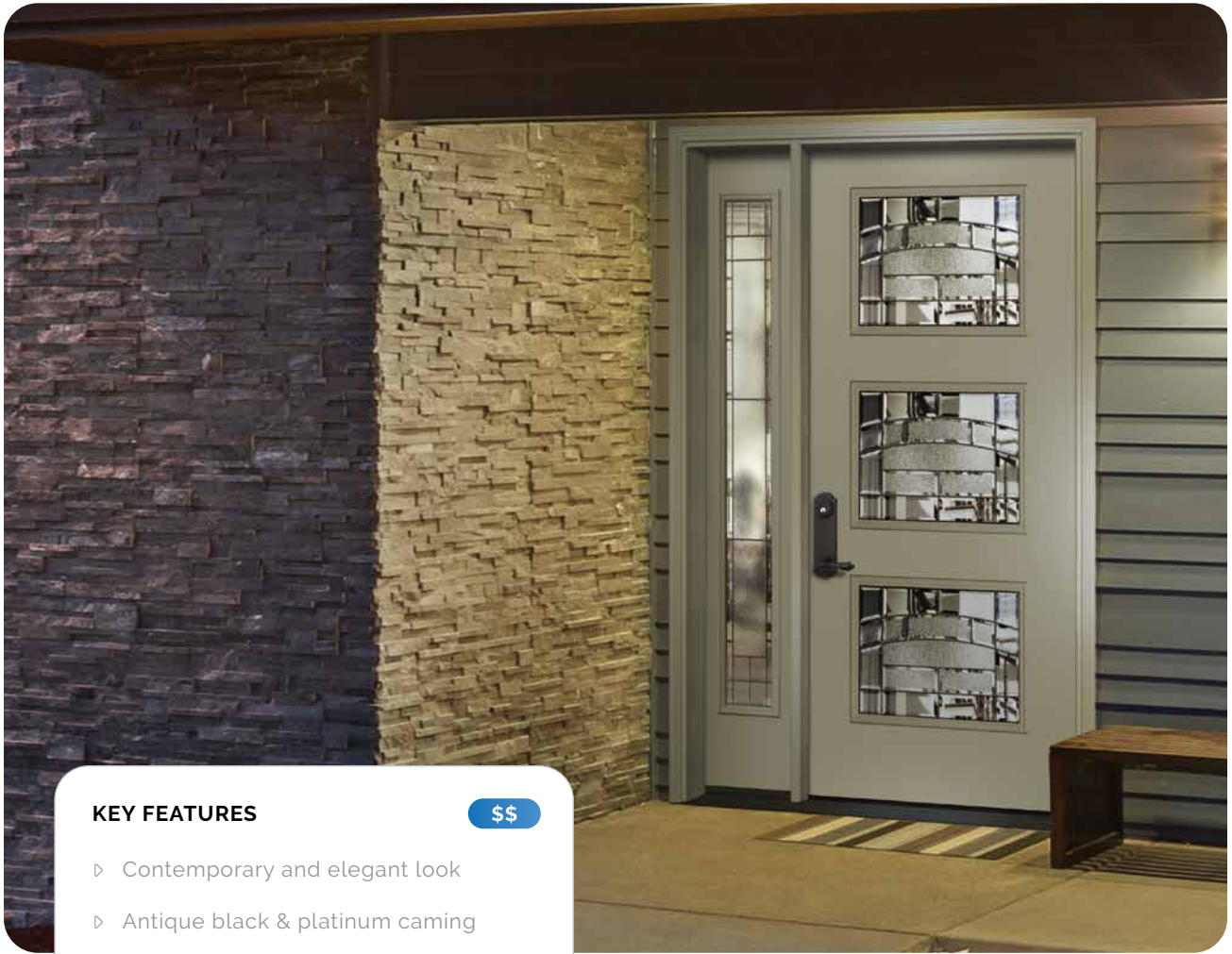

## KEY FEATURES



- ▷ Contemporary and elegant look
- ▷ Antique black & platinum caming
- ▷ Granite textured glass



clear  
beveled  
glass

granite  
textured  
glass

granite  
beveled  
glass

antique  
black  
caming

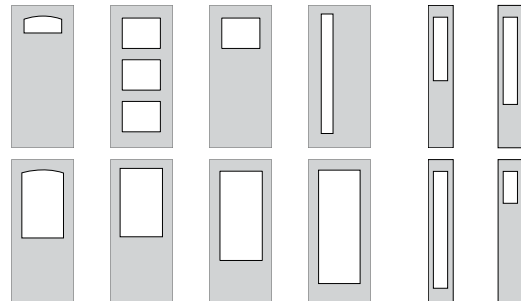

## PRIVACY



Explore all available styles on page 108

# Entropy

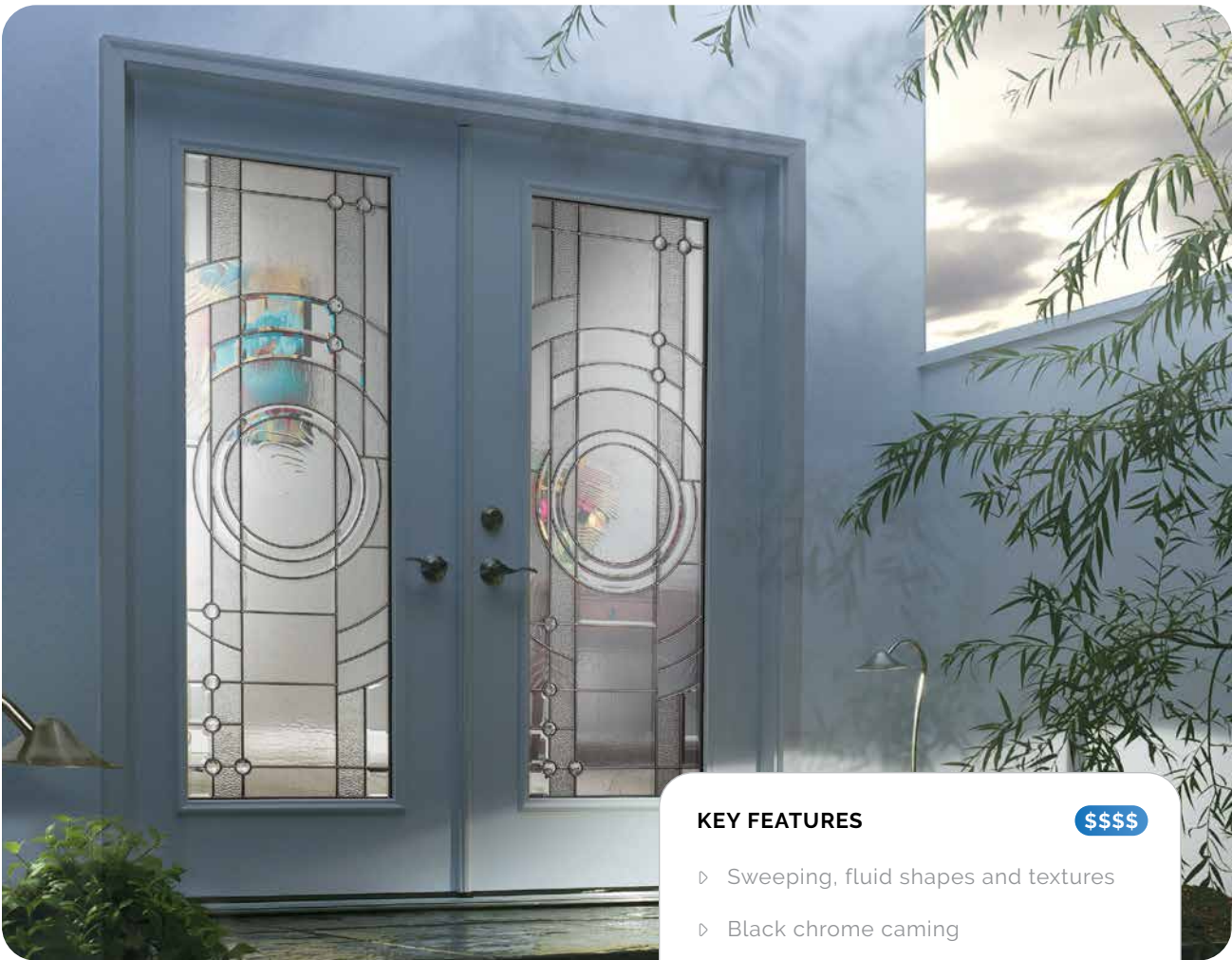

ENTROPY 122 full glass in smooth fibreglass slabs

### KEY FEATURES

\$\$\$

- ▷ Sweeping, fluid shapes and textures
- ▷ Black chrome caming
- ▷ Reversible sidelites

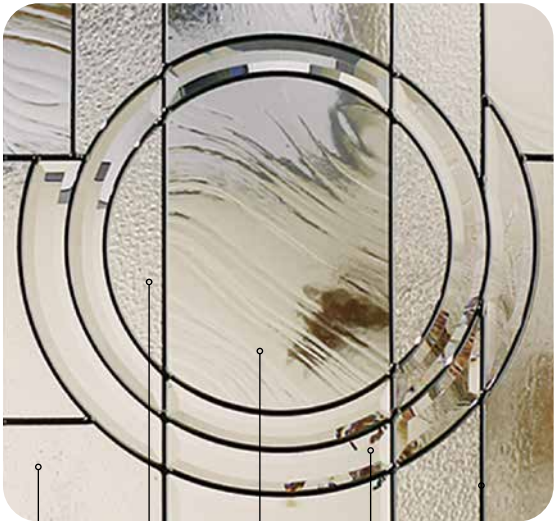

seedy textured glass granite textured glass clear renaissance glass clear beveled glass black chrome caming

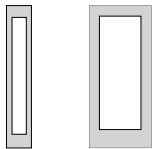

### PRIVACY



Explore all available styles on page 108

# Equation

EQUATION 122 full glass in smooth fibreglass slabs

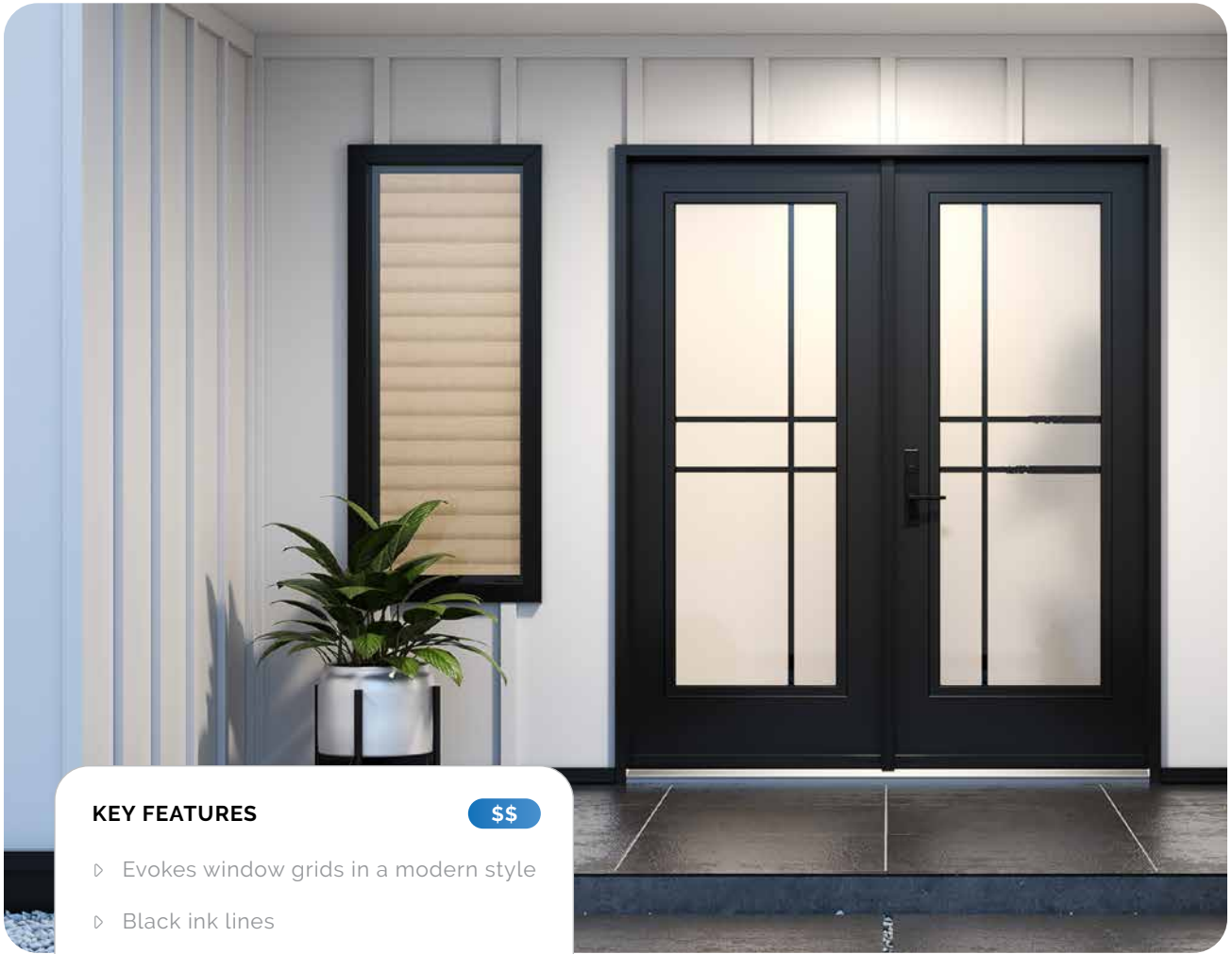

## KEY FEATURES

\$\$

- ▷ Evokes window grids in a modern style
- ▷ Black ink lines
- ▷ High privacy rating



black ink lines

clear glass lines

sandblasted glass

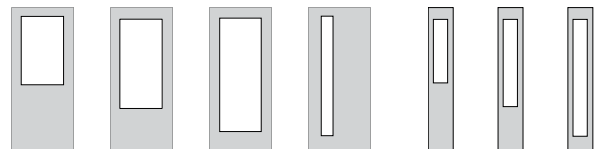

## PRIVACY



Explore all available styles on page 108



# Fluid

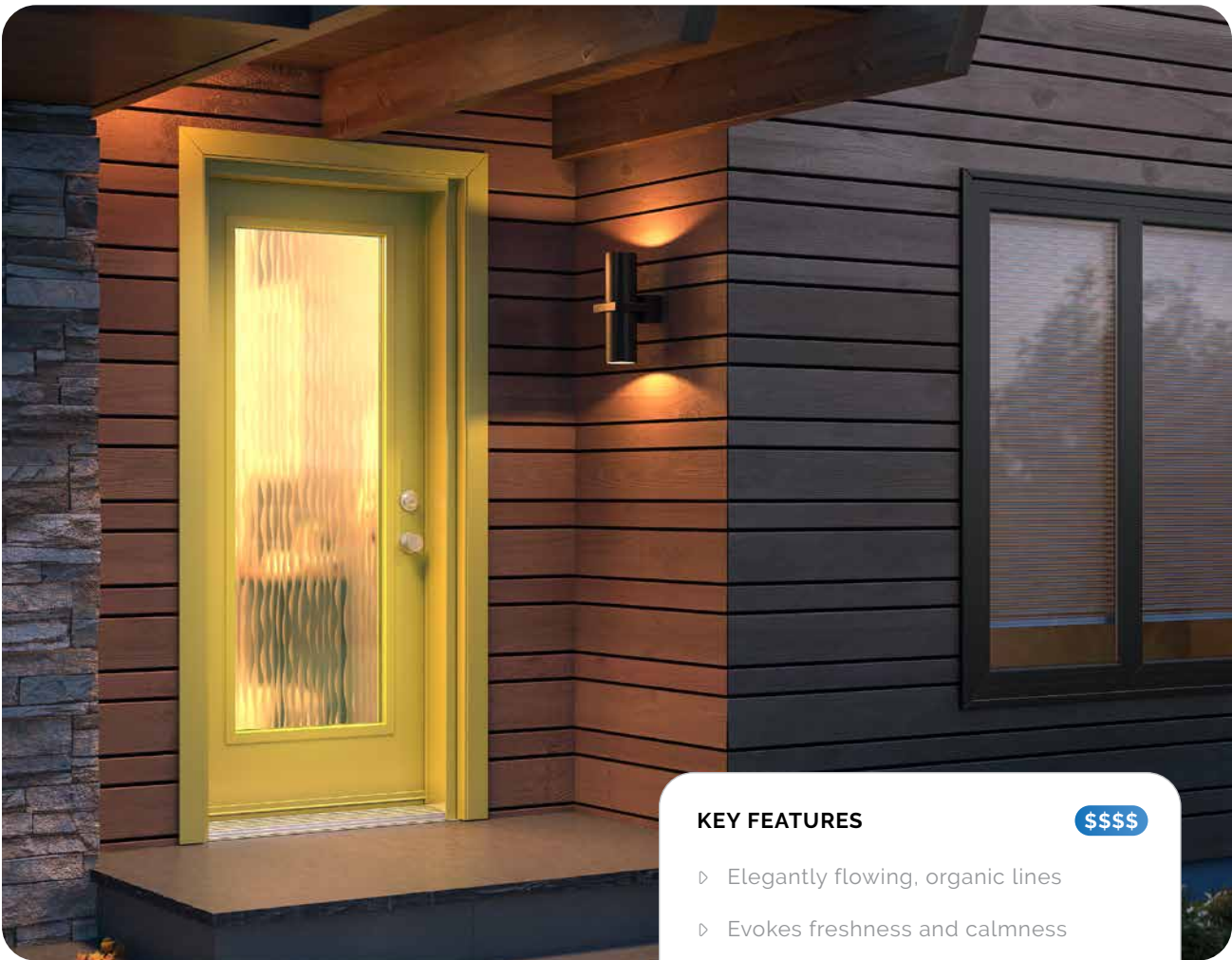

FLUID 122 full glass in a smooth fibreglass slab

**KEY FEATURES** \$\$\$

- ▷ Elegantly flowing, organic lines
- ▷ Evokes freshness and calmness
- ▷ Fluid textured glass

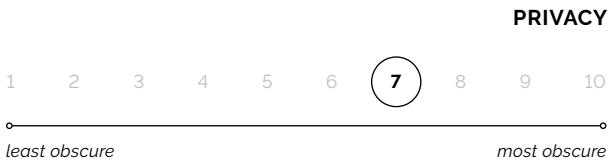
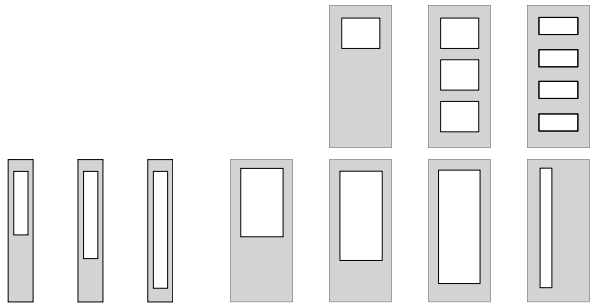

Explore all available styles on page **110**

**FOCUS** 217 glass in a smooth fibreglass slab with a clear transom

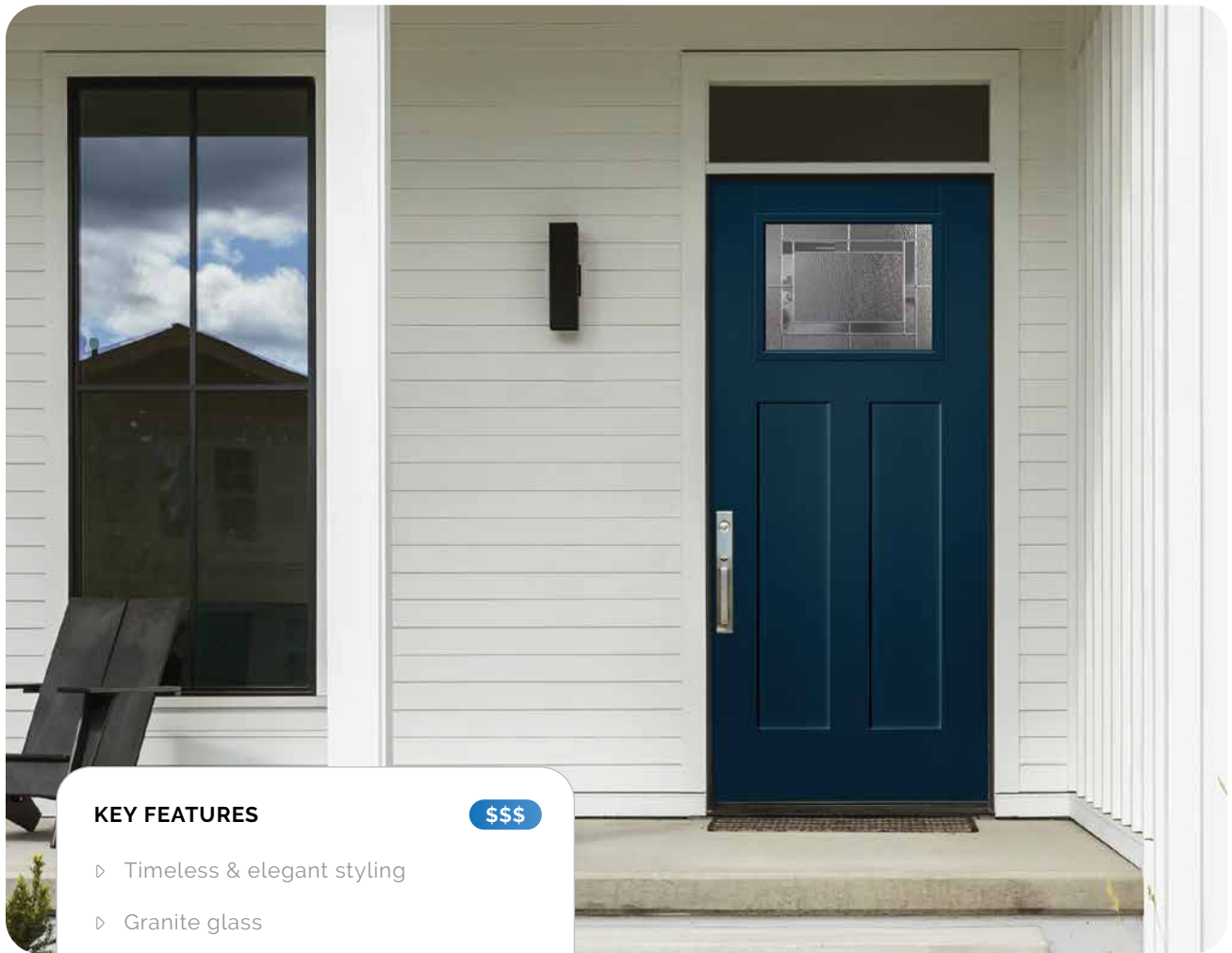

**KEY FEATURES** \$\$\$

- ▷ Timeless & elegant styling
- ▷ Granite glass
- ▷ Platinum caming



platinum caming

granite glass

clear glass

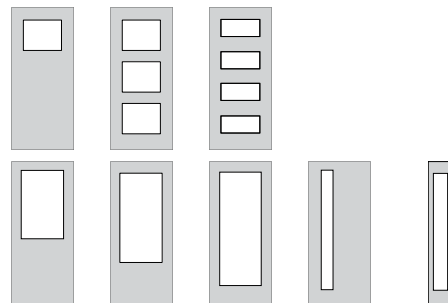

**PRIVACY**

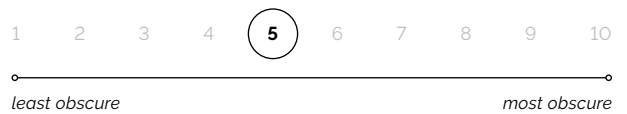

Explore all available styles on page **110**

# Frontier®

FRONTIER® 404 3/4 glass in a smooth fibreglass slab with clear glass sidelites and transom

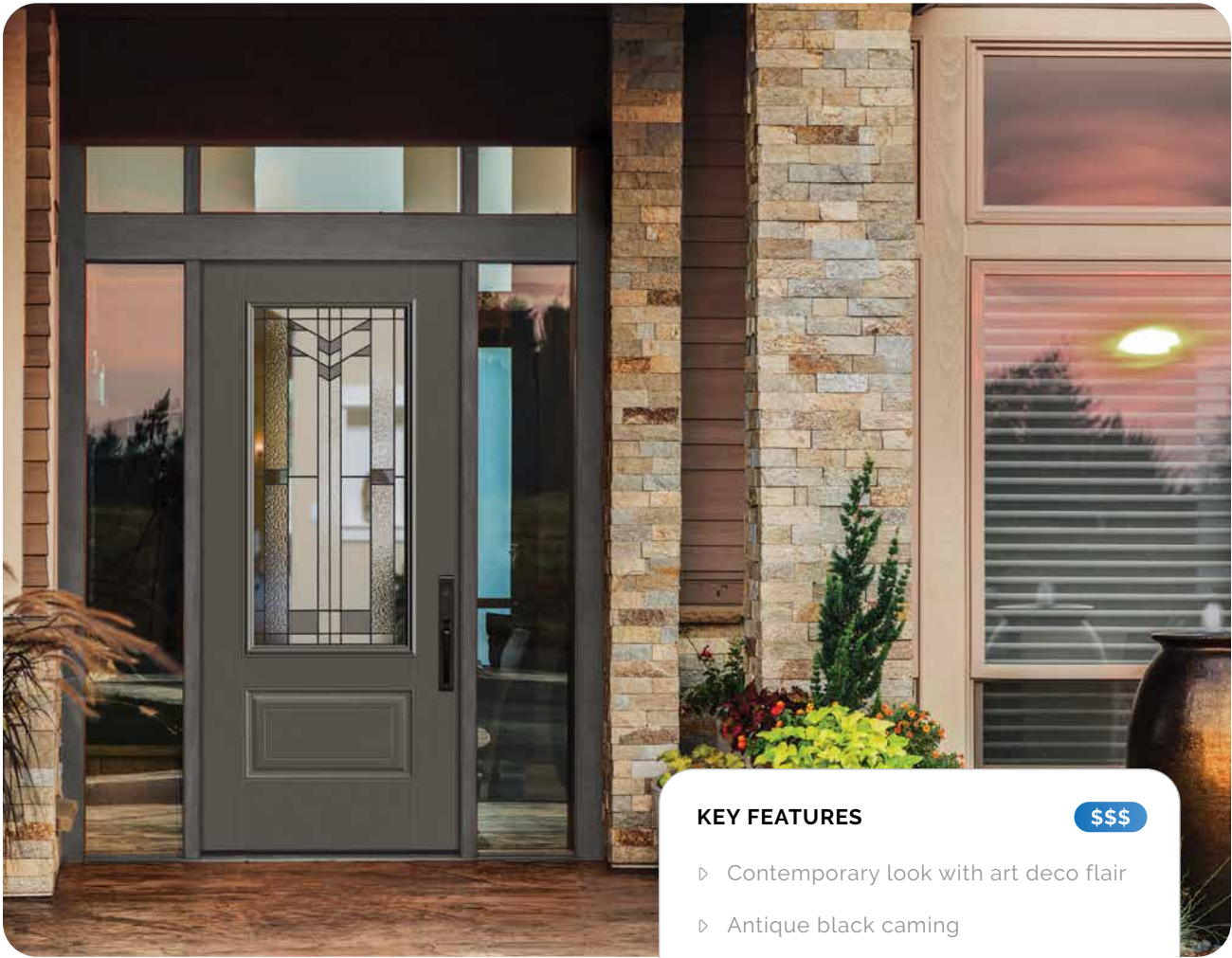

## KEY FEATURES

\$\$\$

- ▷ Contemporary look with art deco flair
- ▷ Antique black caming
- ▷ Grey water glass

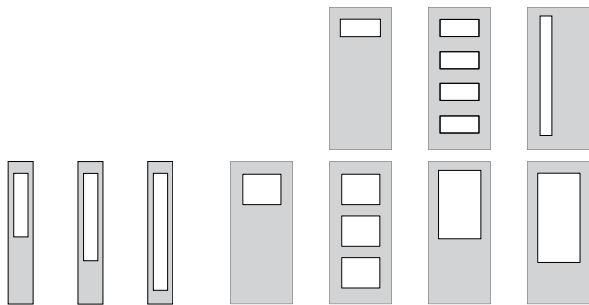

## PRIVACY



pear textured glass

seedy textured glass

grey water glass

antique black caming

Explore all available styles on page 110



GEORGIAN™ 404 3/4 glass in a smooth fibreglass slab with 450 3/4 sidelites

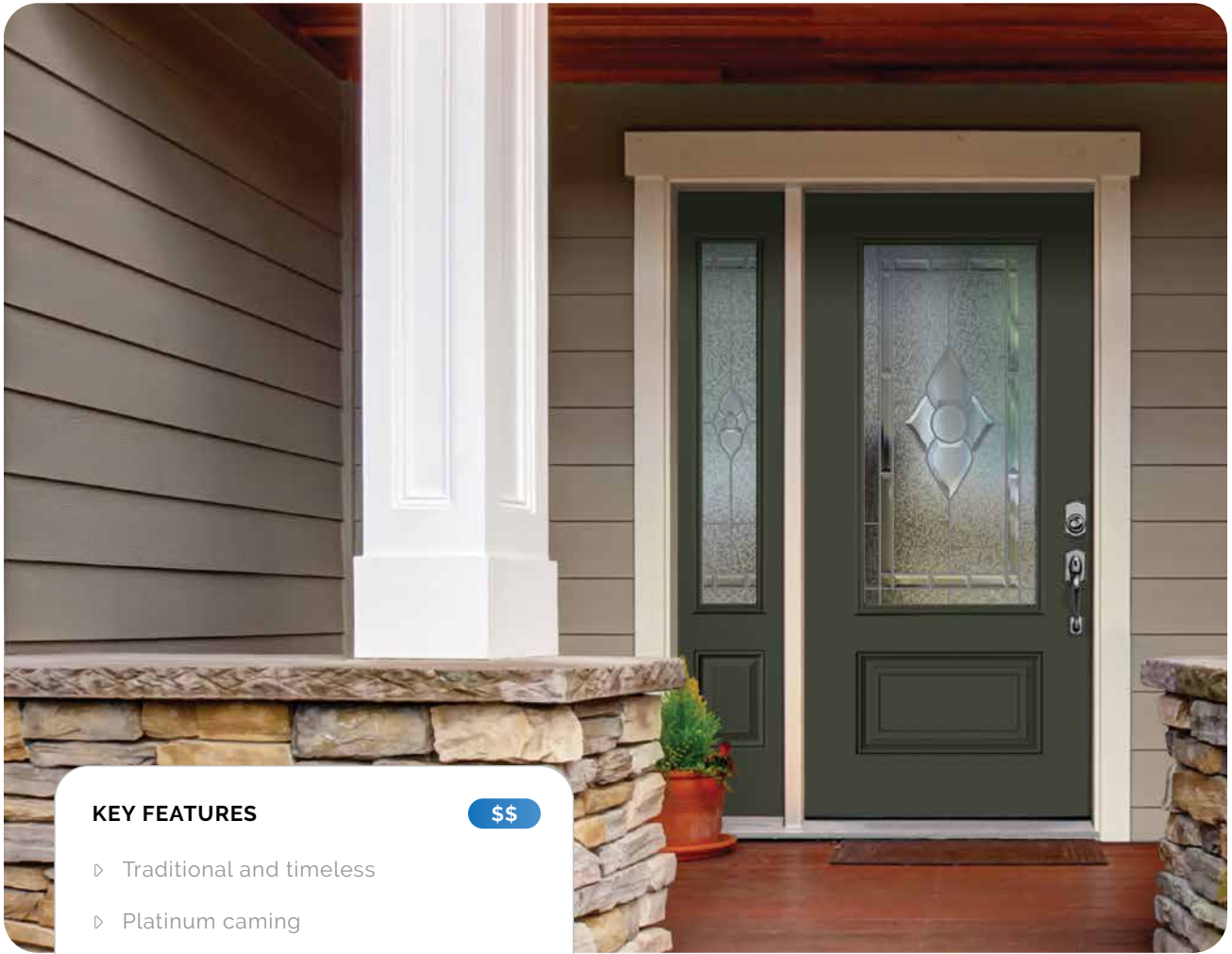

## KEY FEATURES

\$\$

- ▷ Traditional and timeless
- ▷ Platinum caming
- ▷ Glue chip textured glass



platinum caming

glue chip textured glass

clear beveled glass

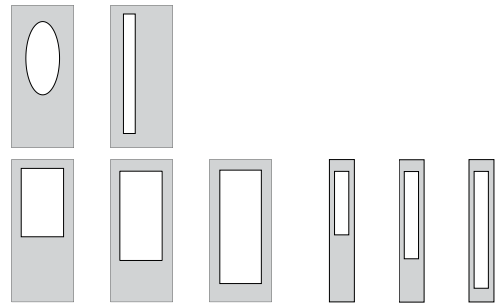

## PRIVACY



Explore all available styles on page 110

# Harlow

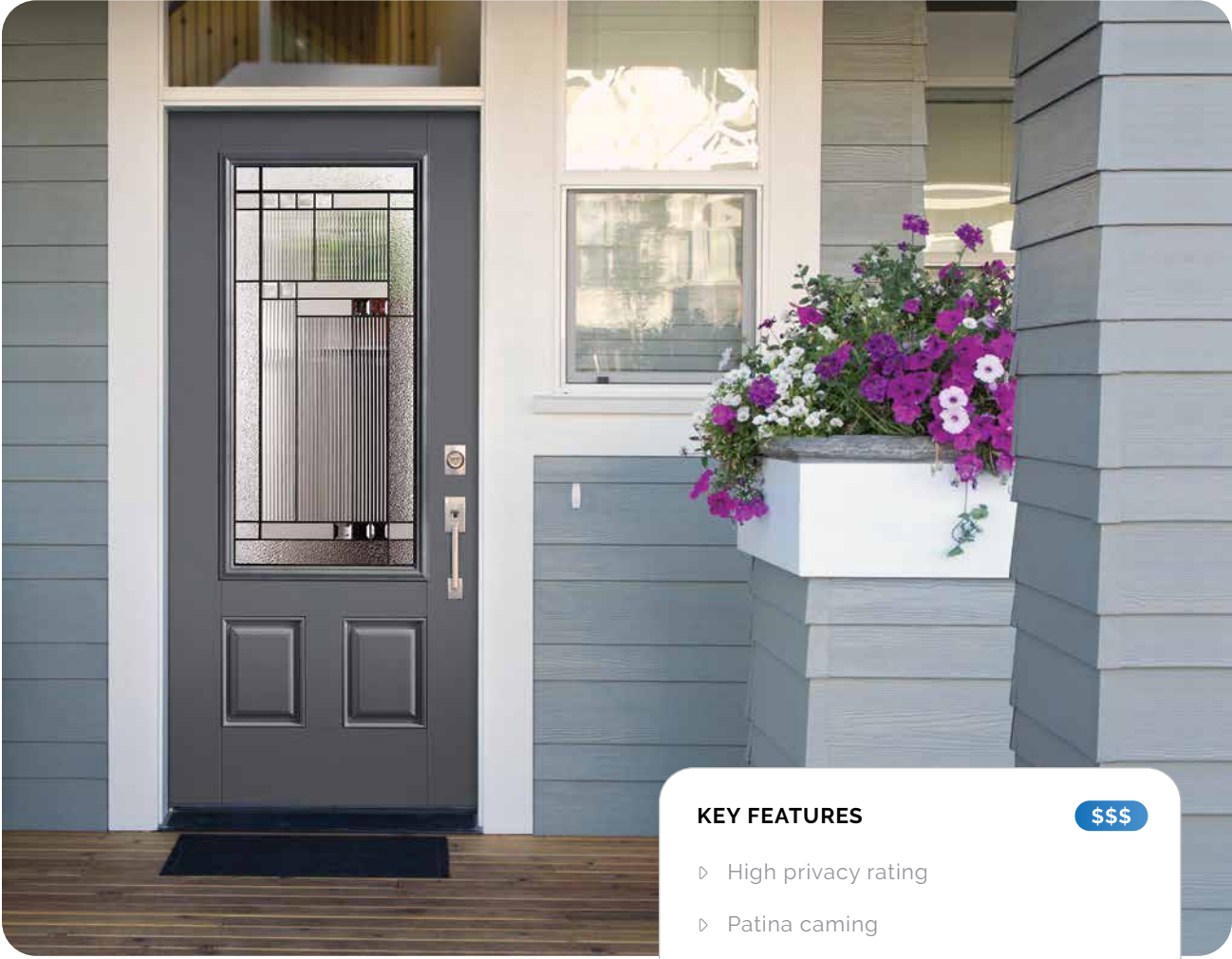

HARLOW 404 3/4 glass in a smooth fiberglass slab

**KEY FEATURES** \$\$\$

- ▷ High privacy rating
- ▷ Patina caming
- ▷ Narrow reed textured glass

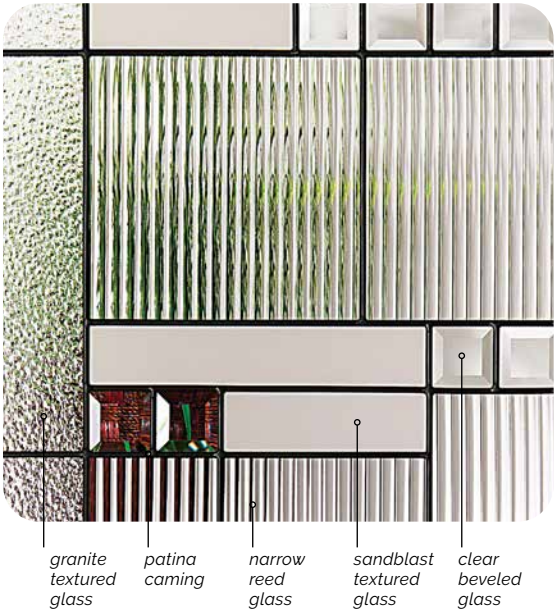
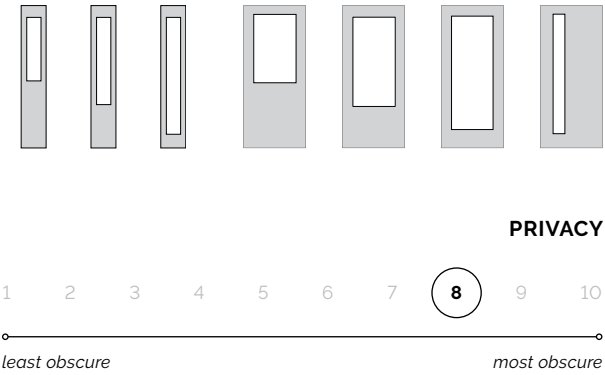

Explore all available styles on page **110**

HOLLISTER 122 full glass in a smooth fibreglass slab

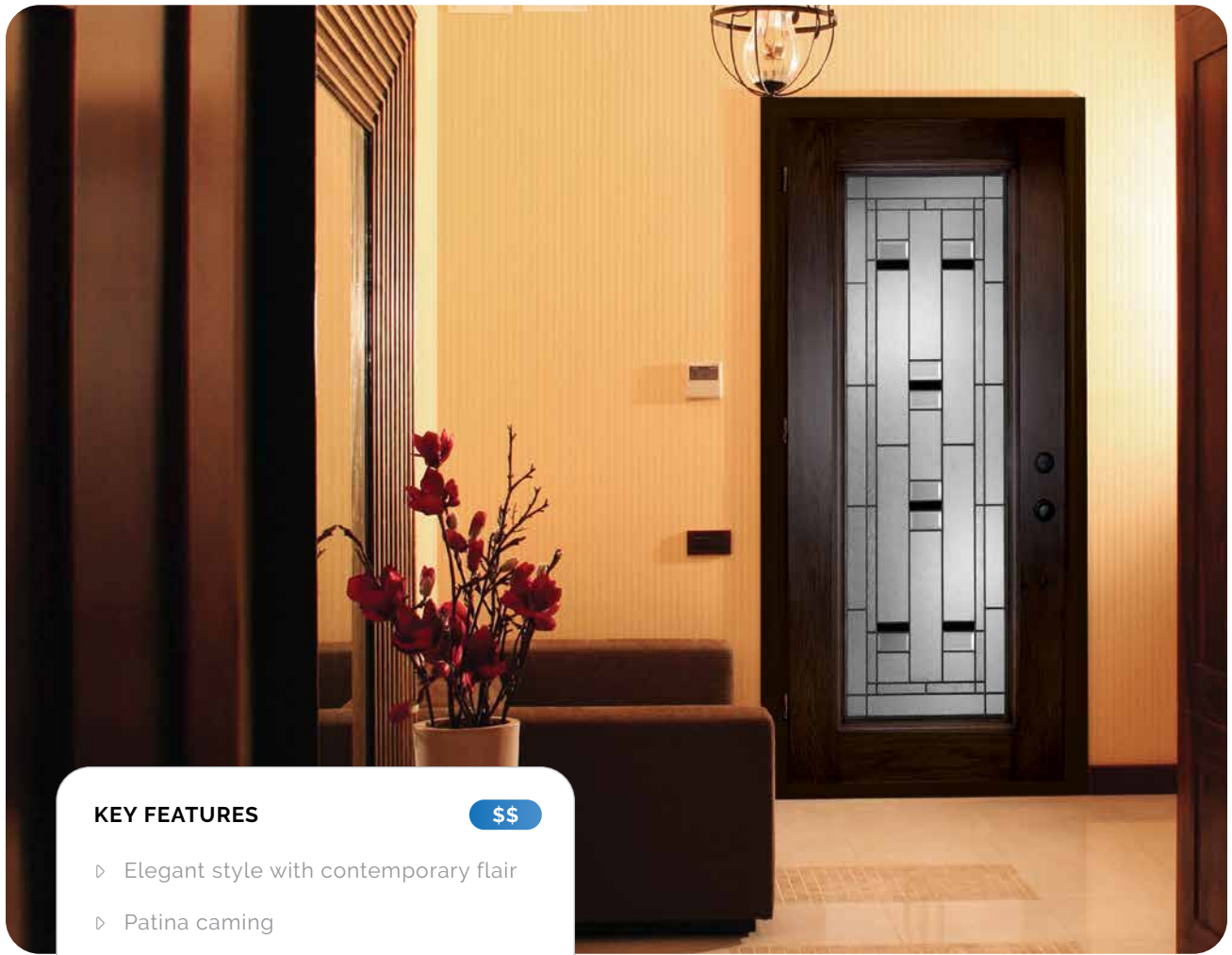

## KEY FEATURES

\$\$

- ▷ Elegant style with contemporary flair
- ▷ Patina caming
- ▷ Kasumi textured glass

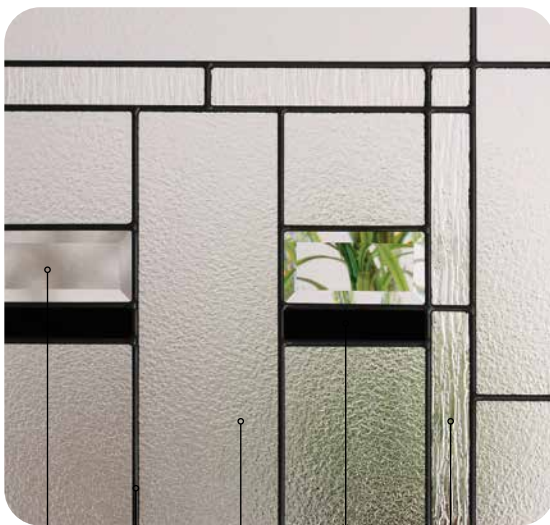

clear  
beveled  
glass

patina  
caming

kasumi  
textured  
glass

black  
glass

rain  
textured  
glass

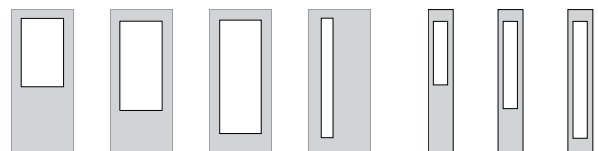

## PRIVACY



Explore all available styles on page **110**



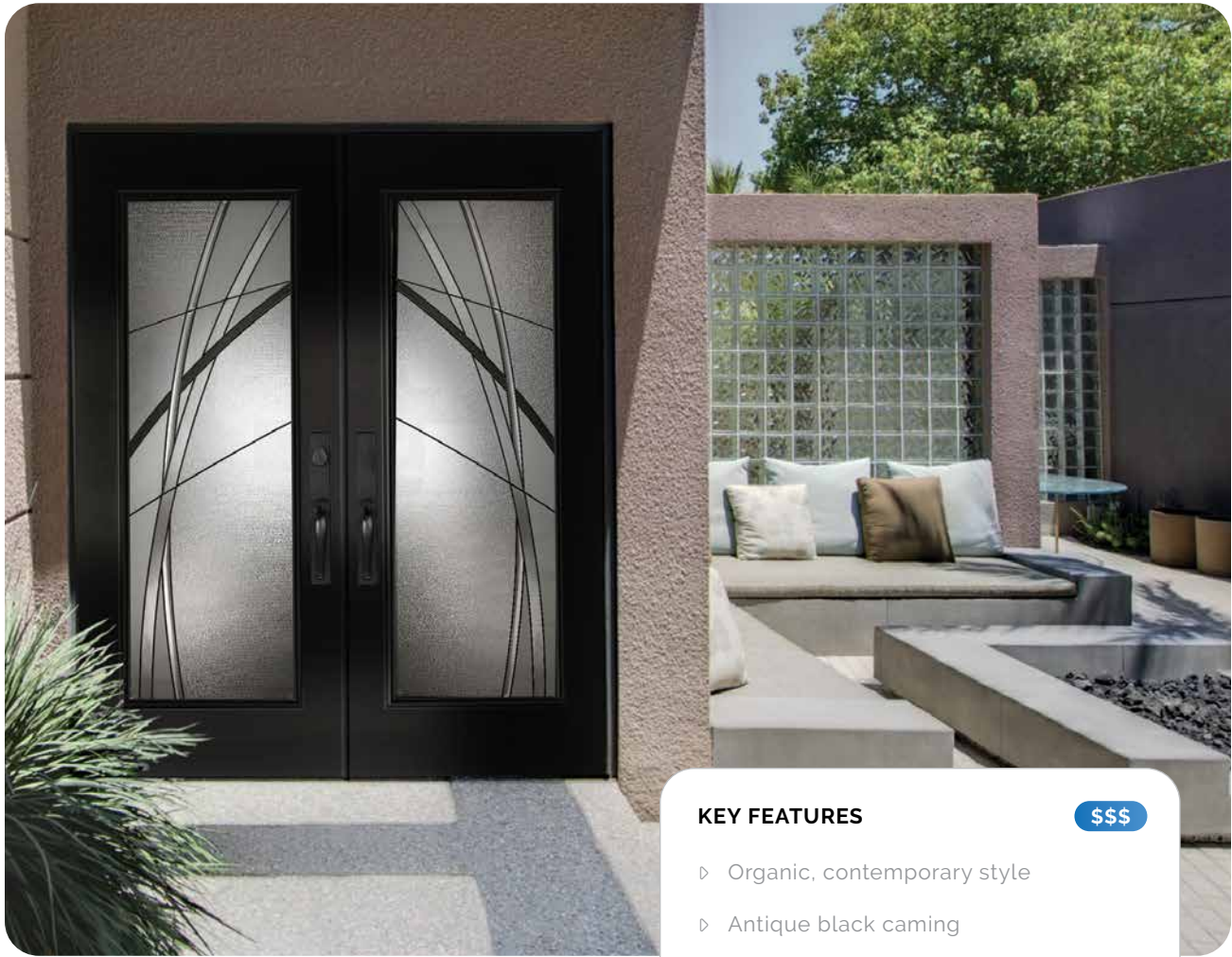

### KEY FEATURES

\$\$\$

- ▷ Organic, contemporary style
- ▷ Antique black caming
- ▷ Reversible glass for a dramatic look

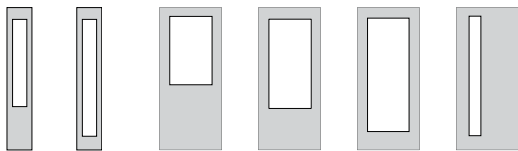

### PRIVACY

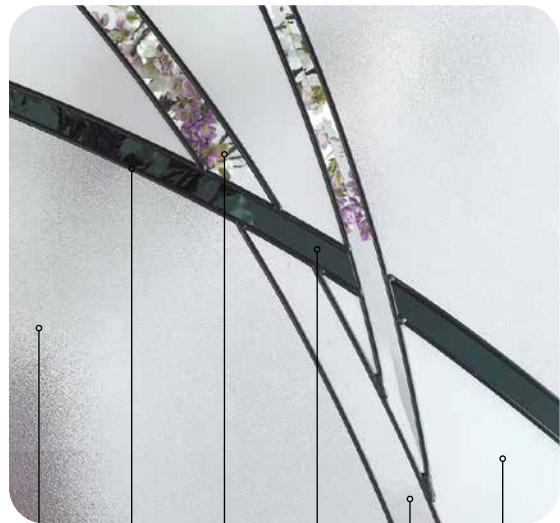

- pear textured glass
- antique black caming
- clear beveled glass
- dark grey glass
- seedy textured glass
- white etched glass

Explore all available styles on page **110**

# Lexington

LEXINGTON 106 1/2 glass in steel slabs

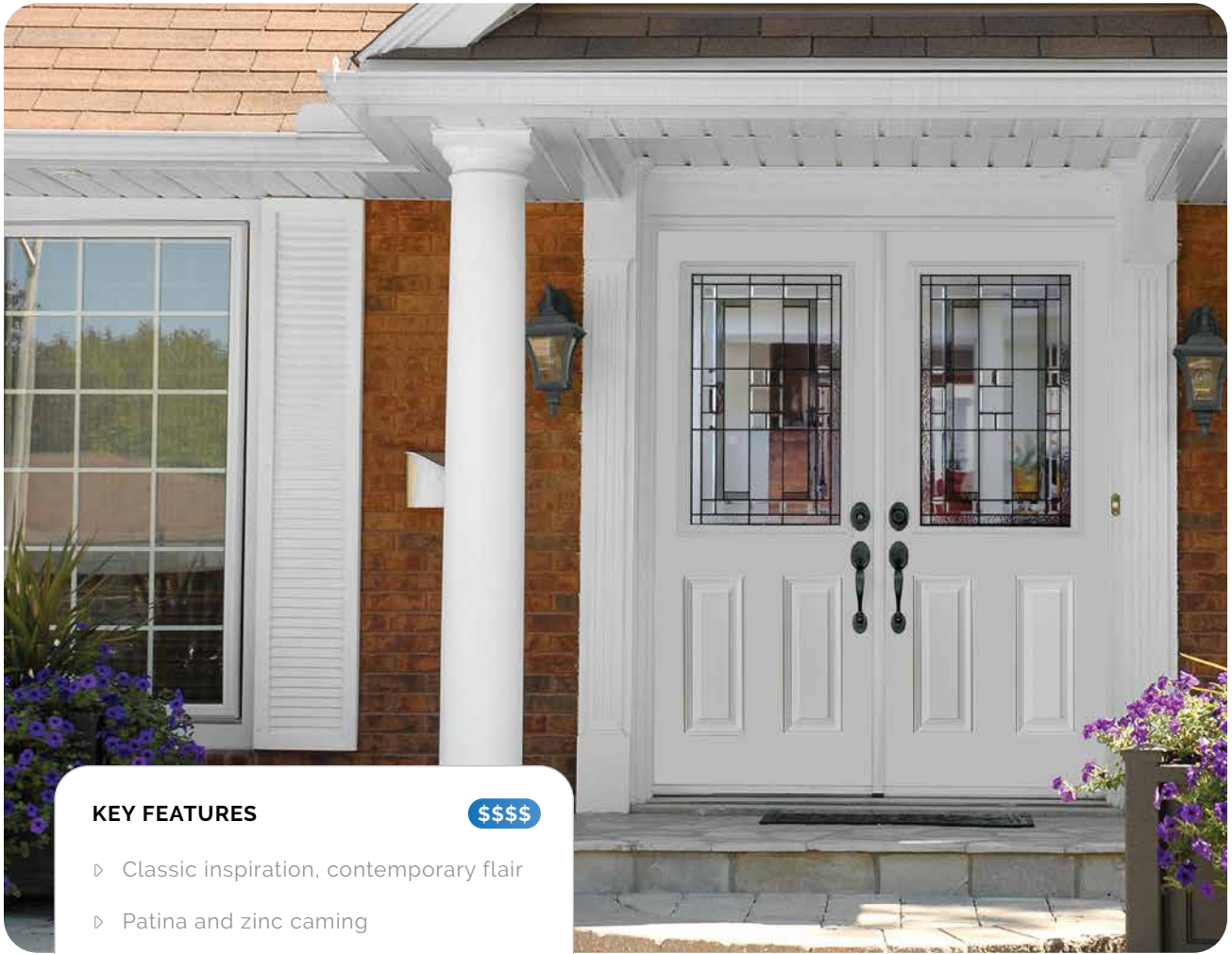

## KEY FEATURES

\$\$\$\$

- ▷ Classic inspiration, contemporary flair
- ▷ Patina and zinc caming
- ▷ Drawn and grey ripple textured glass



clear ripple glass

grey ripple glass

drawn textured glass

clear beveled glass

patina caming

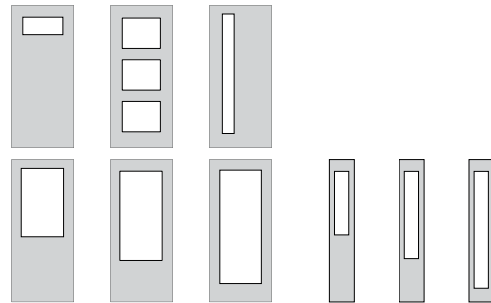

## PRIVACY



Explore all available styles on page **110**

Photos shown throughout this catalogue are for illustrative purposes only. This includes all displayed hardware, colours, finishes, and configurations, which may differ in availability and/or appearance on the final product. All doors come unfinished and do not include lockset/handle hardware unless otherwise specified.

# Louisbourg

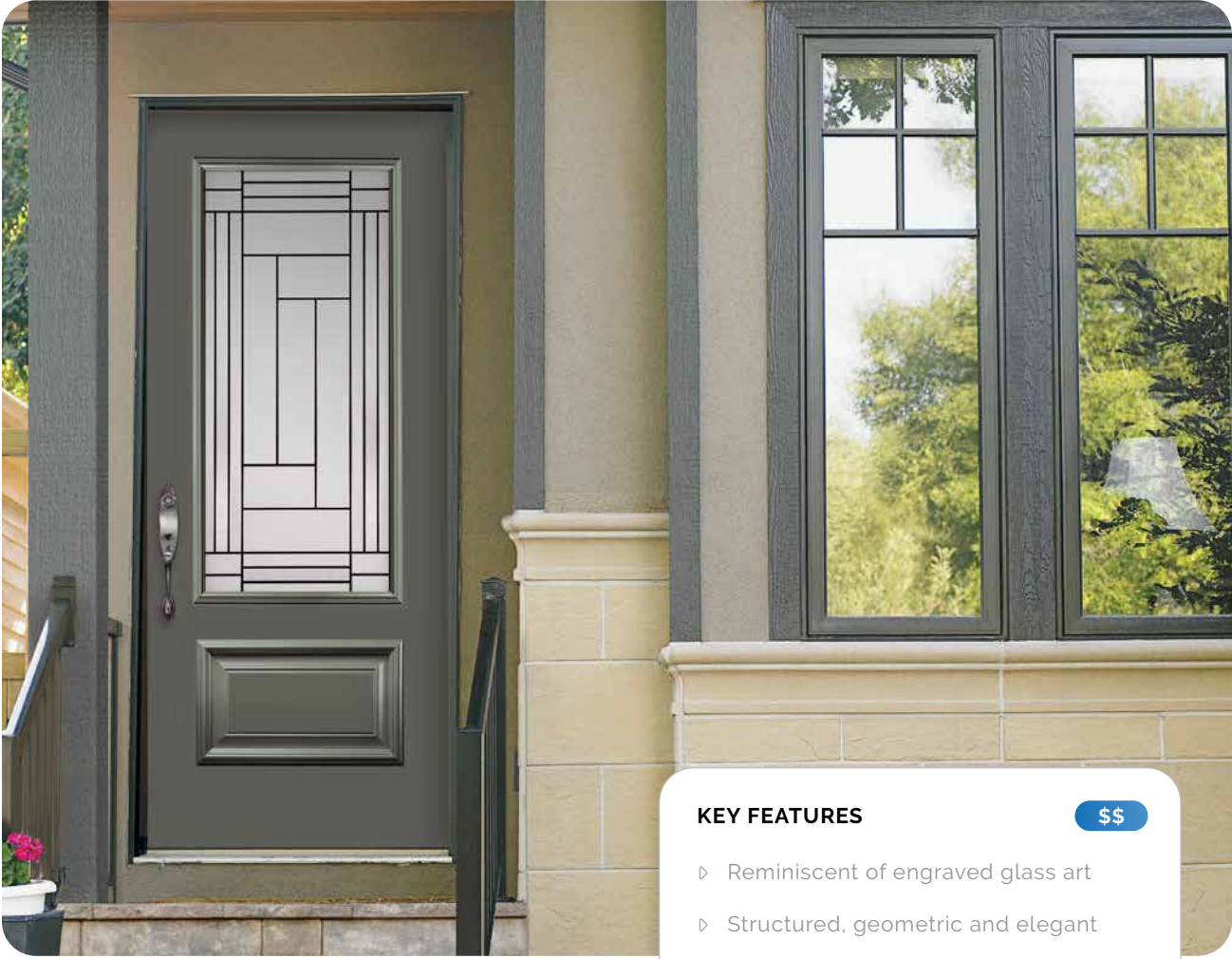

LOUISBOURG 404 3/4 glass in a steel slab

**KEY FEATURES** \$\$

- ▷ Reminiscent of engraved glass art
- ▷ Structured, geometric and elegant
- ▷ Sandblasted & grey ink

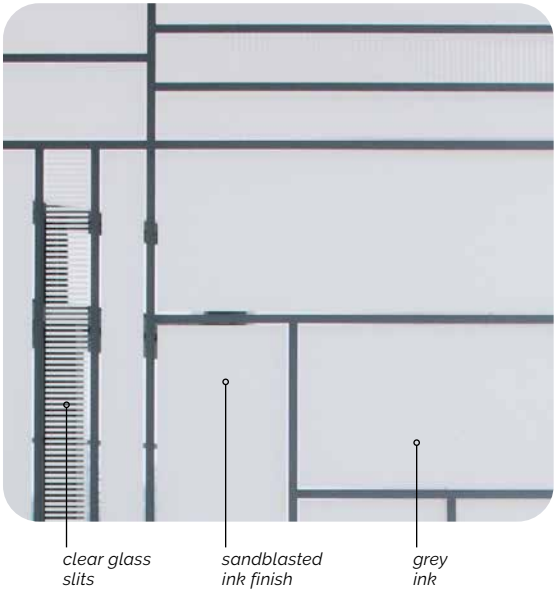
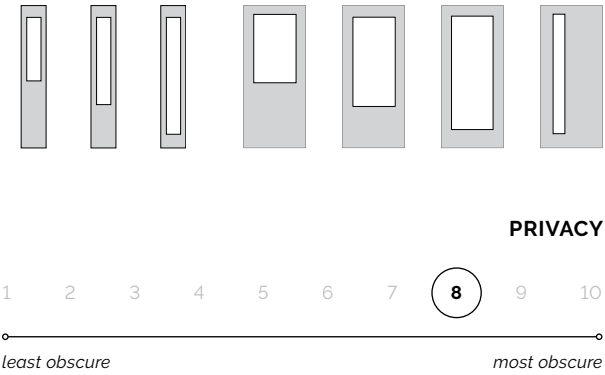

Explore all available styles on page **112**



MARCO® 217 glass in a smooth fibreglass slab with 615 sidelite

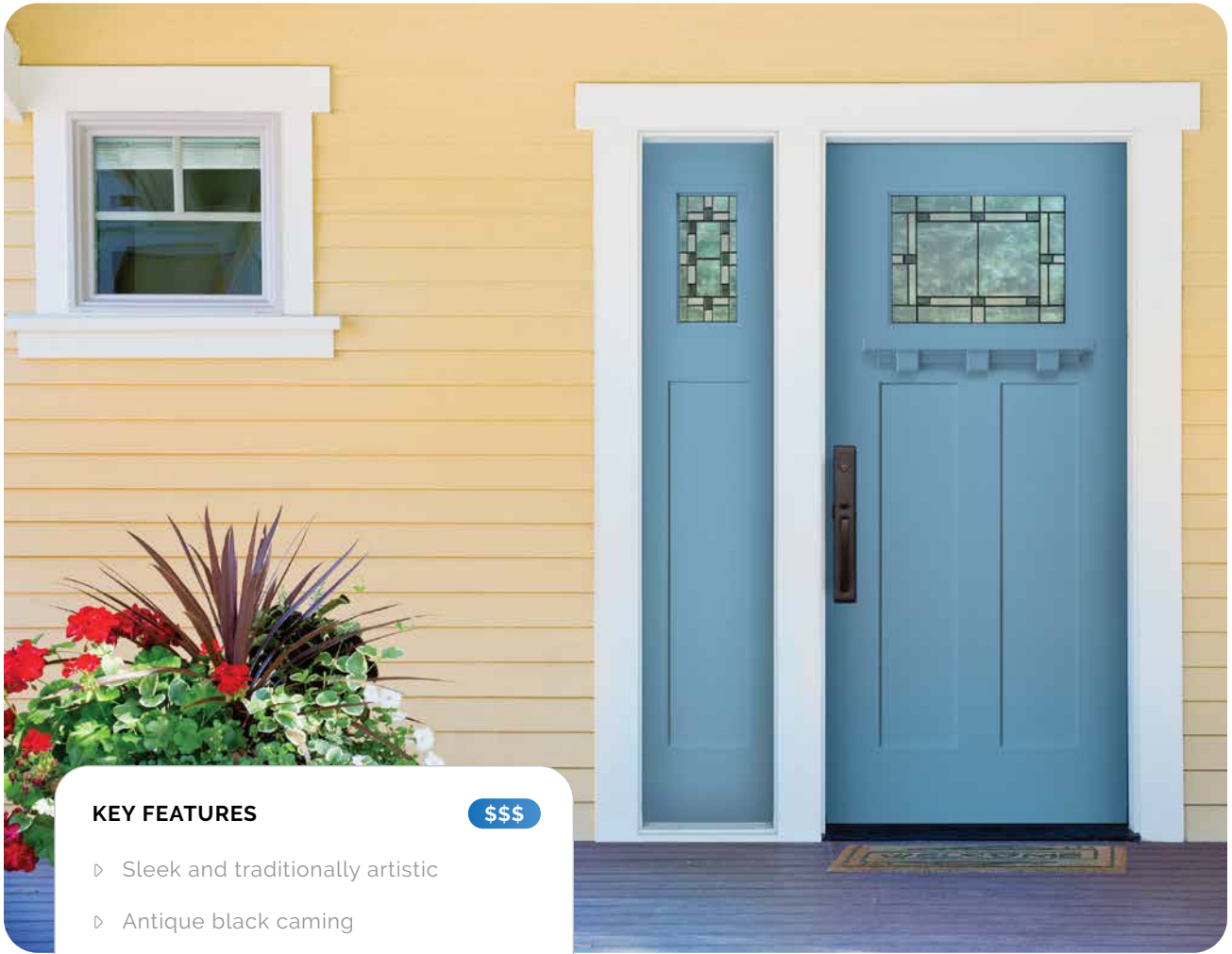

**KEY FEATURES** \$\$\$

- ▷ Sleek and traditionally artistic
- ▷ Antique black caming
- ▷ Grey and clear water glass



clear water glass    granite textured glass    grey water glass    seedy textured glass    antique black caming

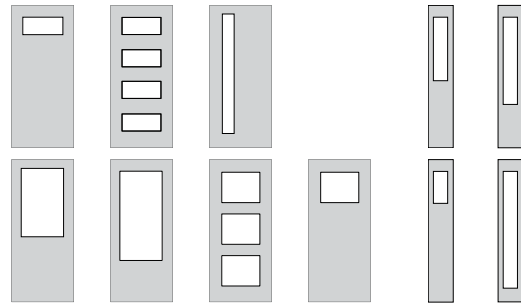

**PRIVACY**



Explore all available styles on page **112**

# Mid-Century Modern

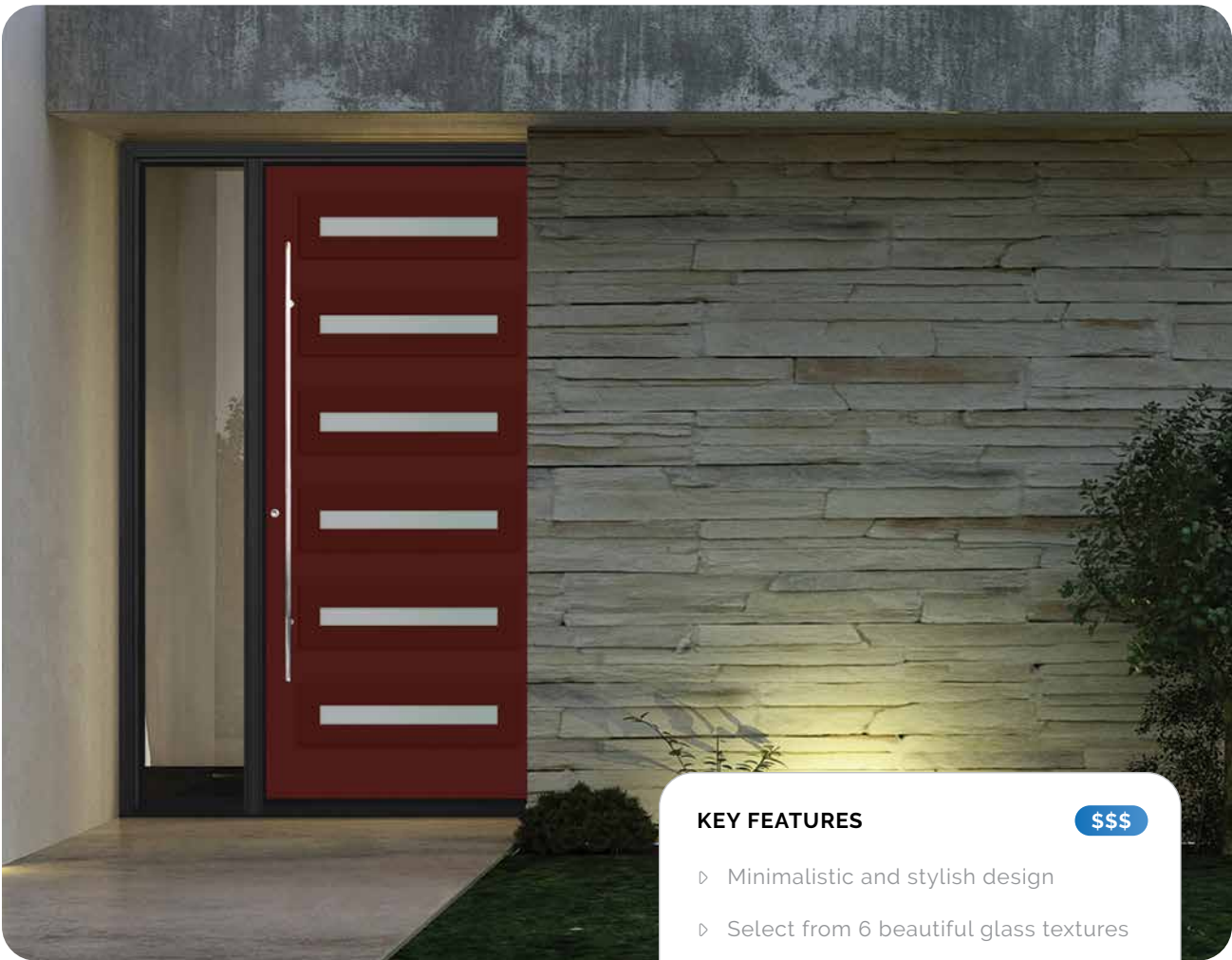

SATIN ETCH 6 x 223 glass in a steel slab with full glass clear sidelite

## KEY FEATURES

\$\$\$

- ▷ Minimalistic and stylish design
- ▷ Select from 6 beautiful glass textures
- ▷ Includes contemporary insert frame

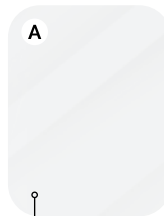
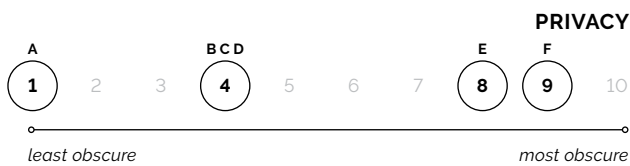
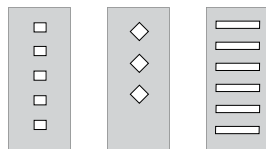

clear glass



sea spray glass

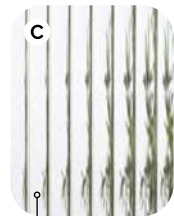

narrow reeded glass

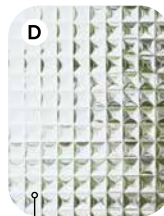

cross reeded glass



sable textured glass

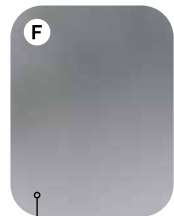

sand blasted glass

Explore all available styles on page 118

MINSTRAL 122 full glass in a smooth fibreglass slab with 152 full sidelites and rain glass transom

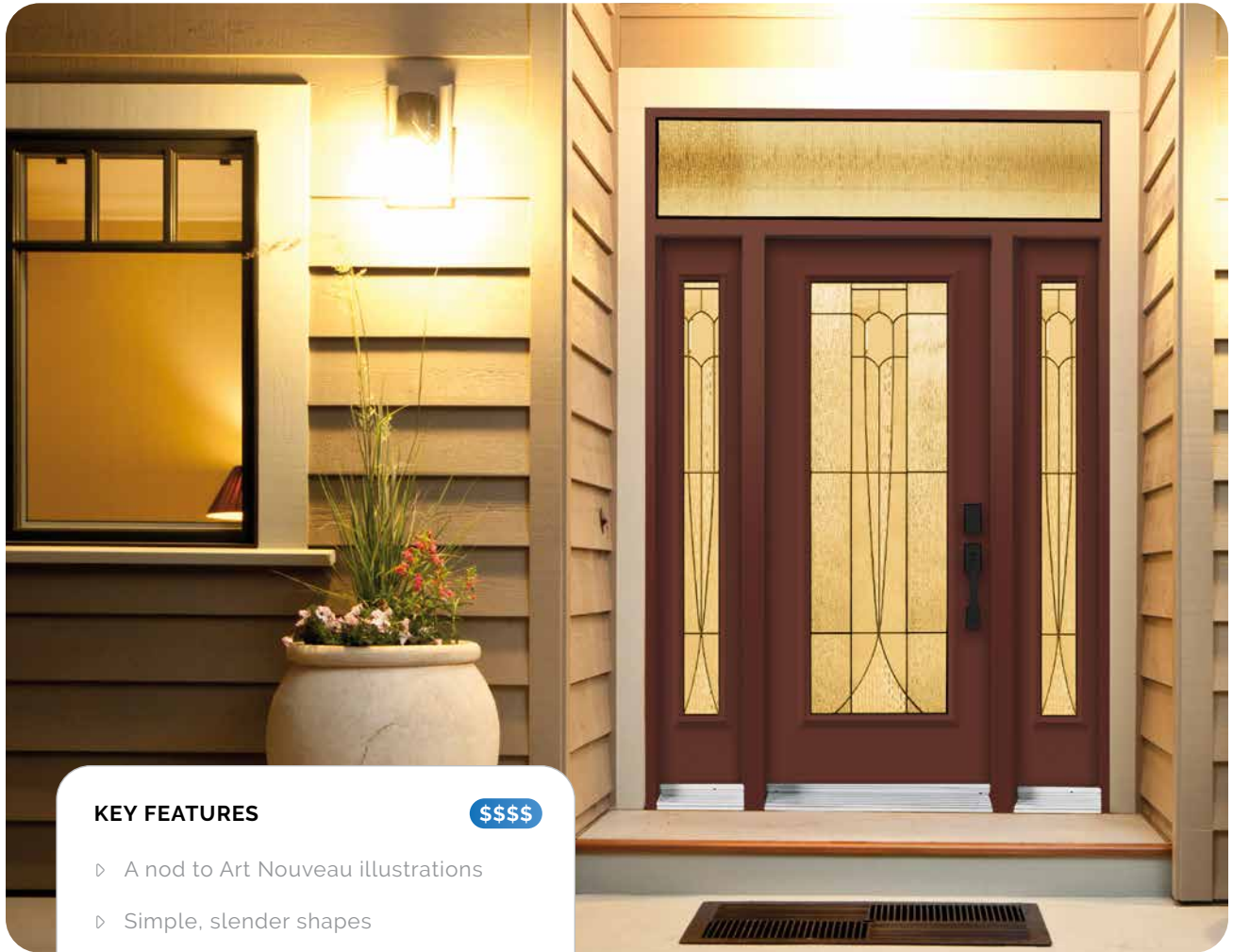

## KEY FEATURES

\$\$\$\$

- ▷ A nod to Art Nouveau illustrations
- ▷ Simple, slender shapes
- ▷ Zinc caming



niagara glass   zinc caming   bevelled pinhead glass   sydney glass   small-hammered glass

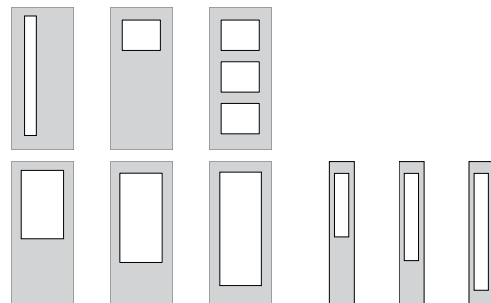

## PRIVACY



Explore all available styles on page **112**



# Modena

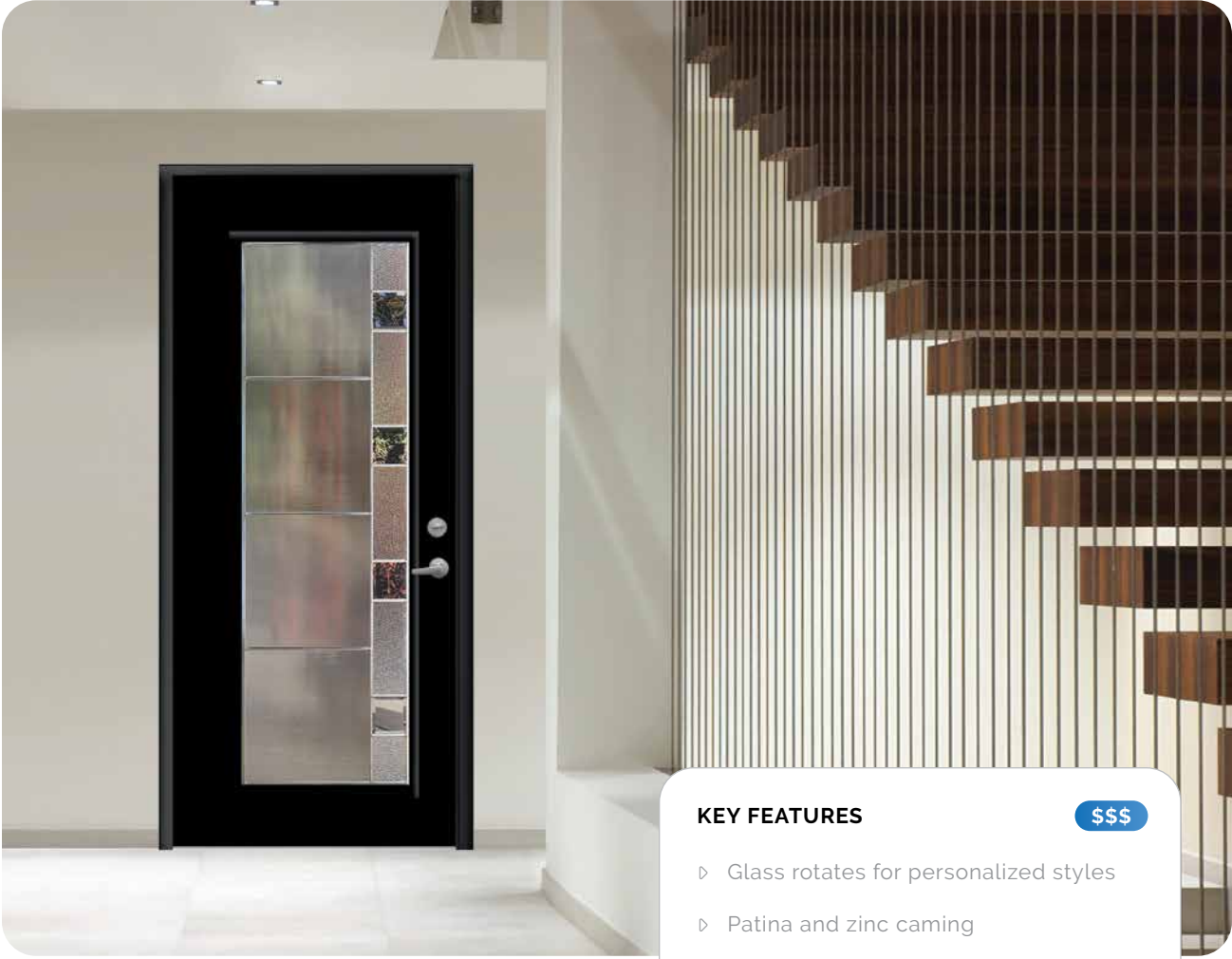

MODENA 122 full glass in a steel slab

**KEY FEATURES** \$\$\$

- ▷ Glass rotates for personalized styles
- ▷ Patina and zinc caming
- ▷ Luminating reed textured glass

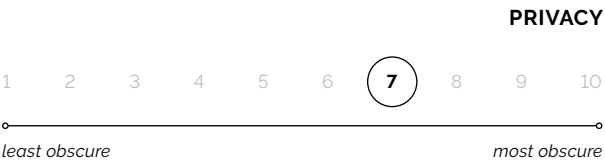
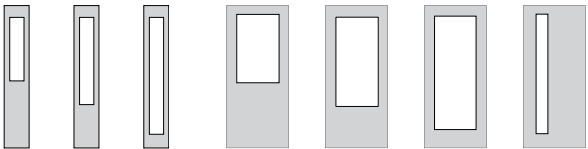

clear beveled glass   granite textured glass   luminating reed glass   patina caming

Explore all available styles on page **112**

# Monterey

MONTEREY 122 full glass in an oak textured fibreglass slab

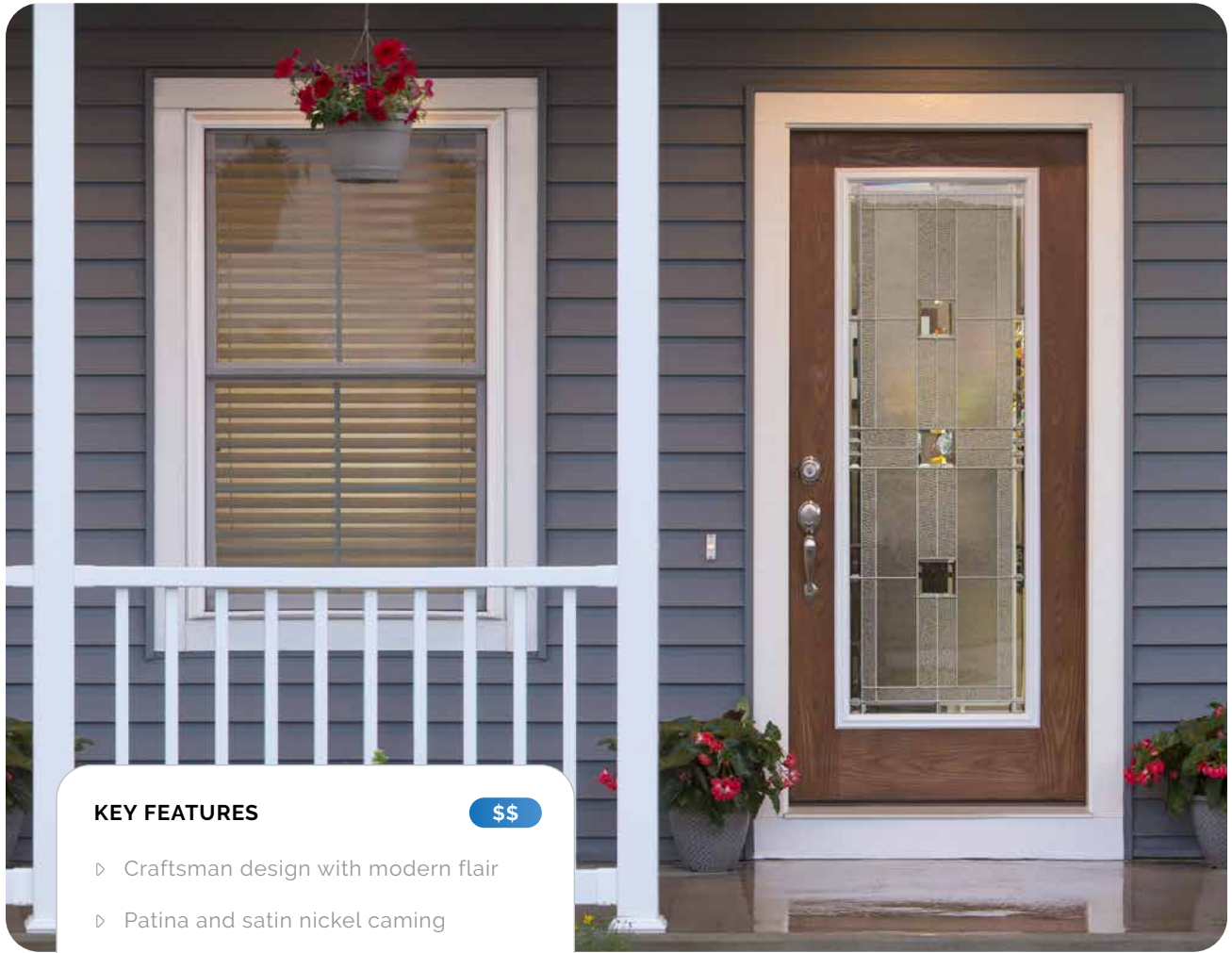

## KEY FEATURES

\$\$

- ▷ Craftsman design with modern flair
- ▷ Patina and satin nickel caming
- ▷ Granite and clear beveled glass



micro granite glass

clear beveled glass

granite textured glass

patina caming

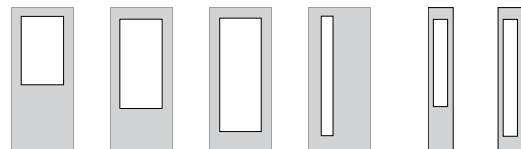

## PRIVACY



Explore all available styles on page **112**

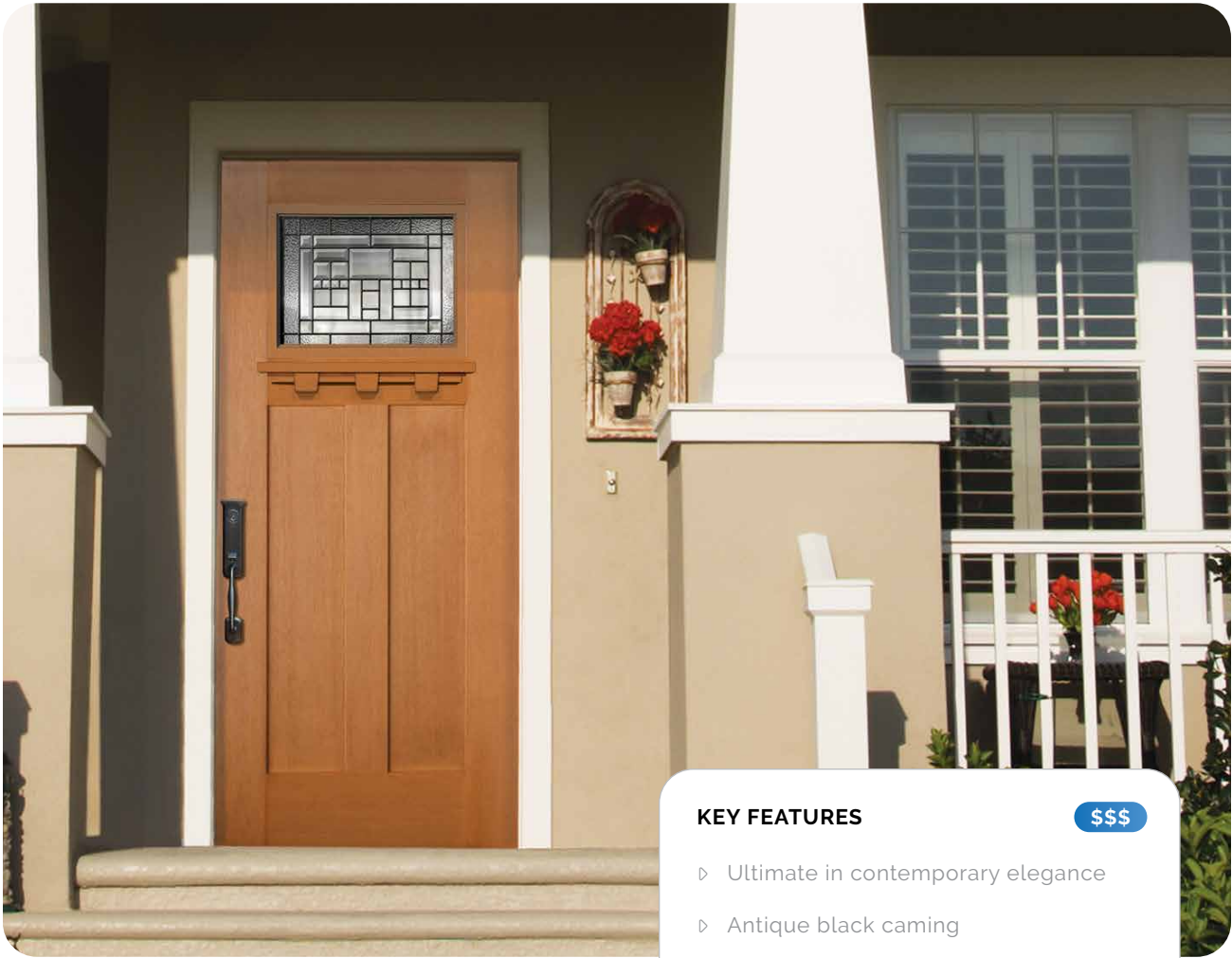

### KEY FEATURES

\$\$\$

- ▷ Ultimate in contemporary elegance
- ▷ Antique black caming
- ▷ Granite and narrow reed glass

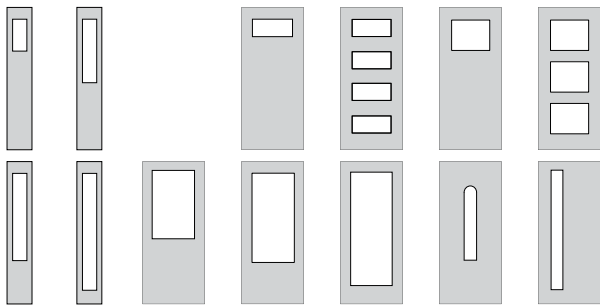

### PRIVACY



granite textured glass

narrow reed glass

clear beveled glass

antique black caming

Explore all available styles on page **112**



NUANDO 122 full glass in a smooth fibreglass slab with opaque sidelite and transom

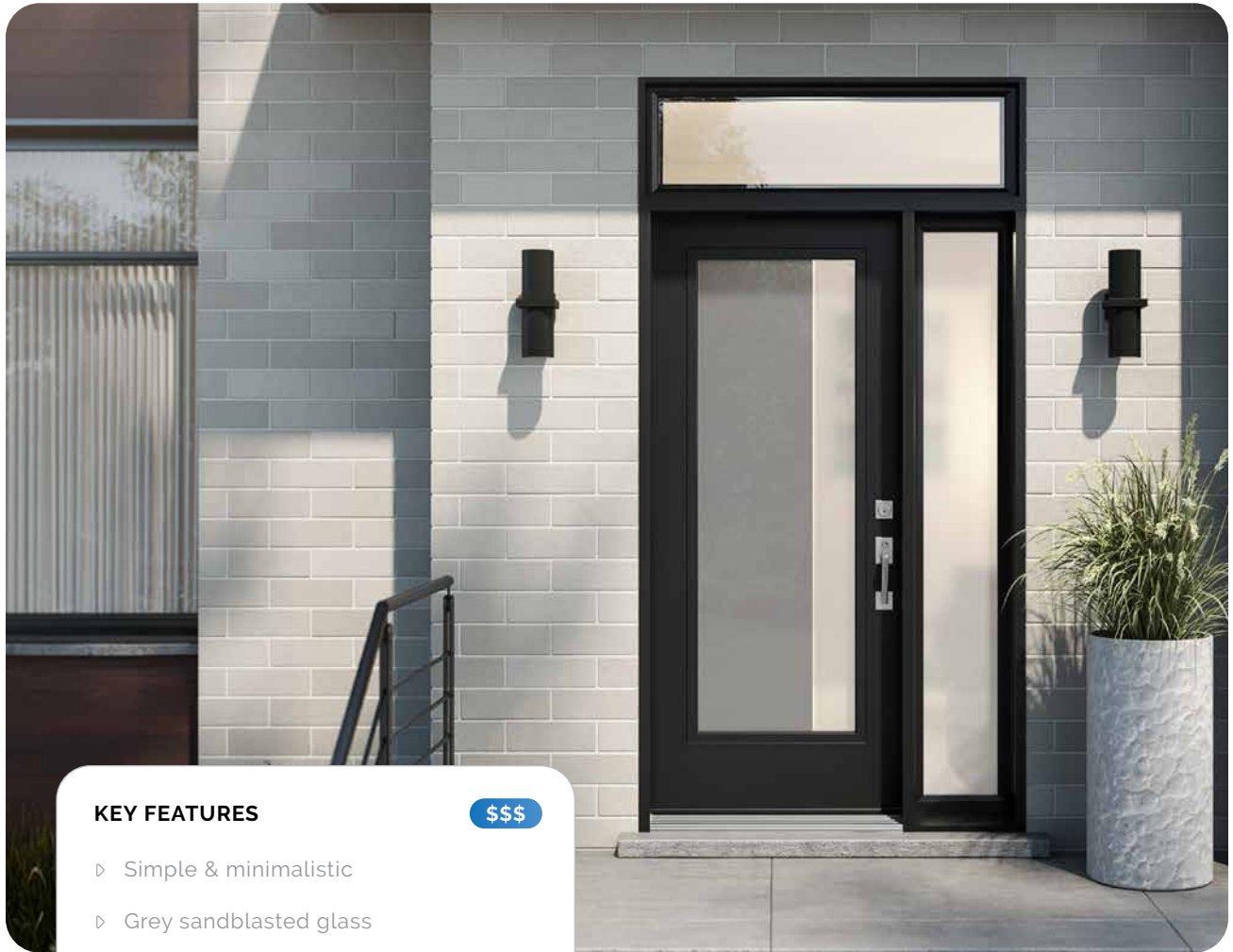

## KEY FEATURES

\$\$\$

- ▷ Simple & minimalistic
- ▷ Grey sandblasted glass
- ▷ Available in left or right orientation

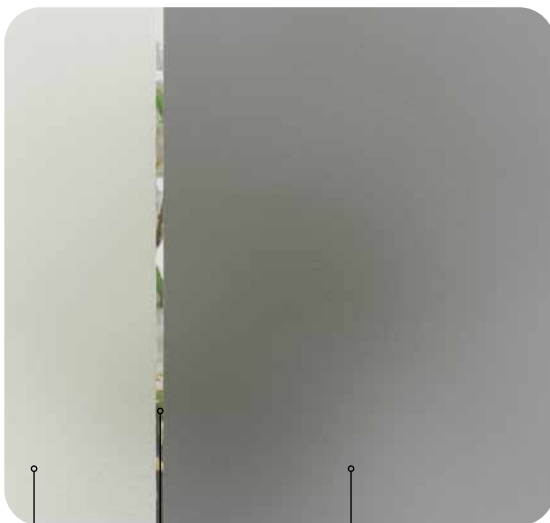

sandblasted glass

clear glass

grey sandblasted glass

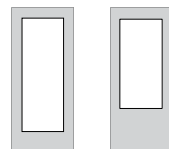

## PRIVACY



Explore all available styles on page **112**

# Opal

OPAL 404 3/4 glass in a steel slab

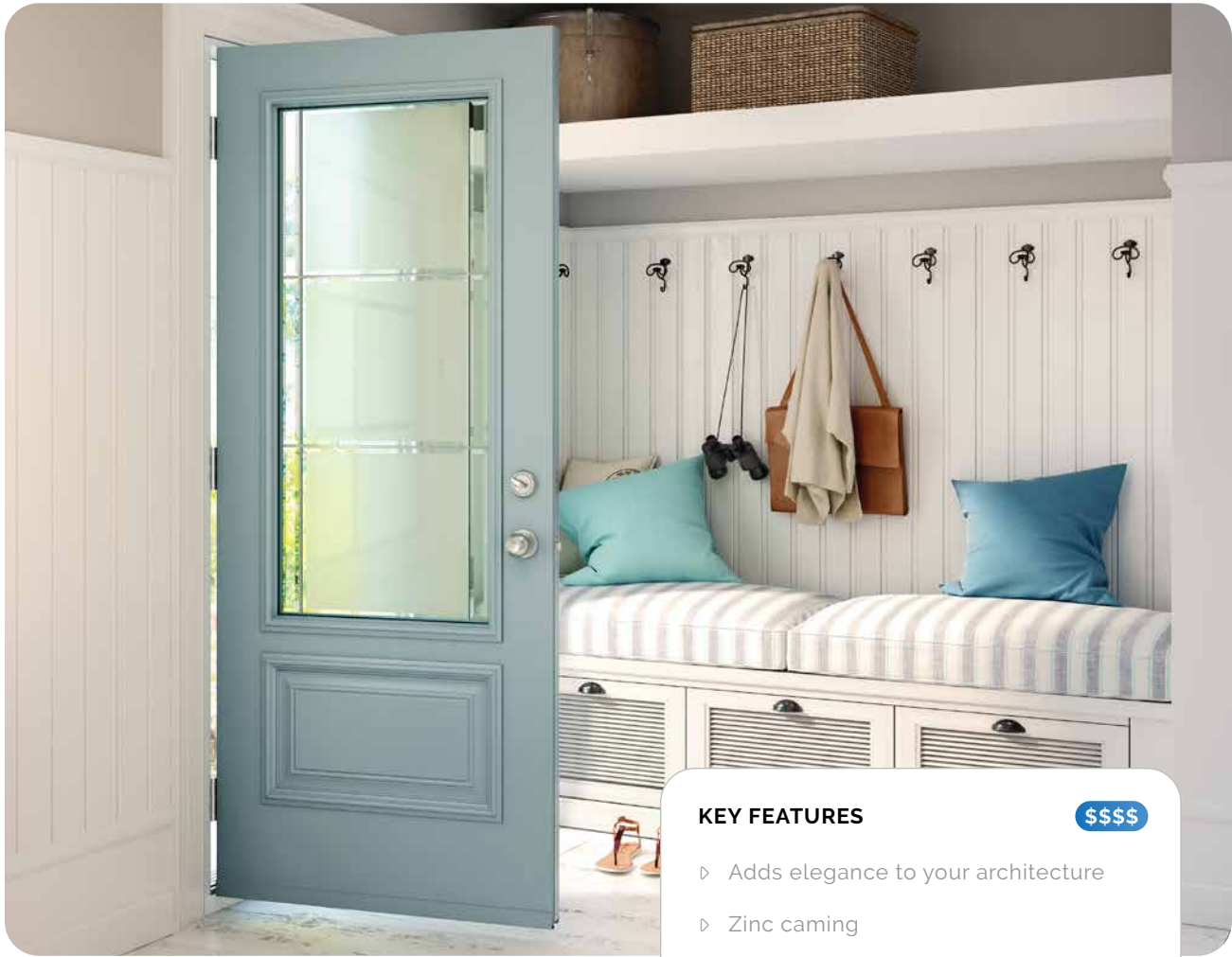

### KEY FEATURES

\$\$\$

- ▷ Adds elegance to your architecture
- ▷ Zinc caming
- ▷ Provides privacy with timeless style

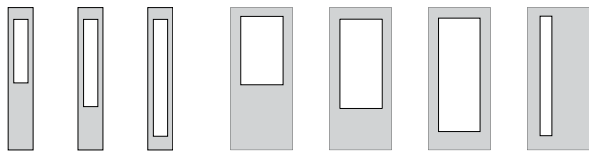

### PRIVACY



beveled clear glass

zinc caming

beveled satin glass

Explore all available styles on page **112**

PANAMA<sup>®</sup> 4o4 3/4 glass in a smooth fibreglass slab with 45o 3/4 sidelites

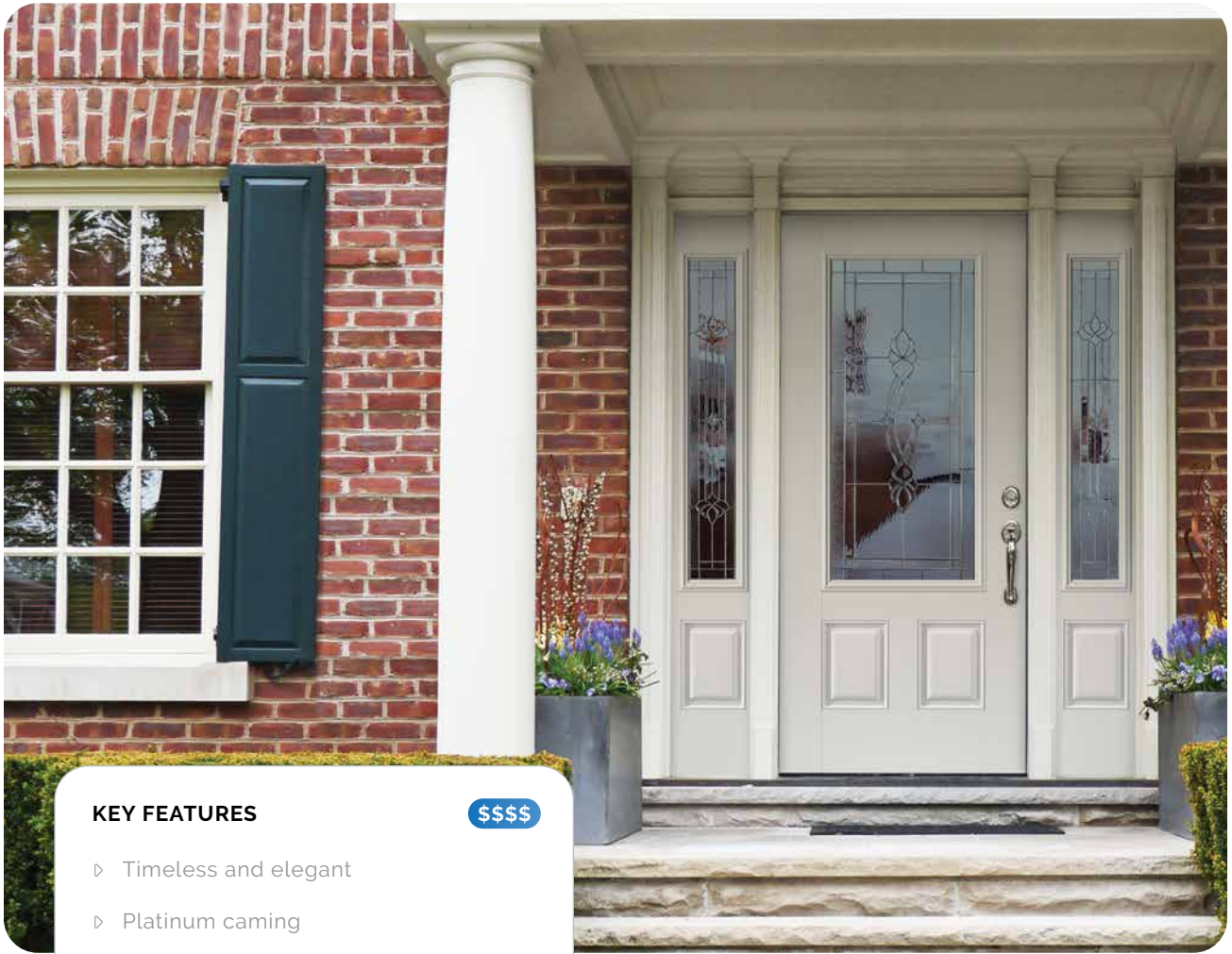

## KEY FEATURES

\$\$\$\$

- ▷ Timeless and elegant
- ▷ Platinum caming
- ▷ Aqua and granite glass



granite textured glass

aqua textured glass

clear beveled glass

platinum caming

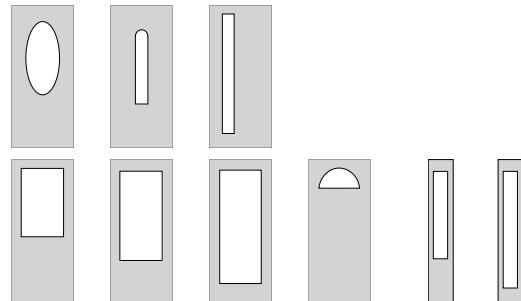

## PRIVACY



Explore all available styles on page 114



# Pear



PEAR 152 full glass in a smooth fibreglass slab

## KEY FEATURES

\$\$

- ▷ Natural and simplistic
- ▷ High privacy rating
- ▷ Pear textured glass

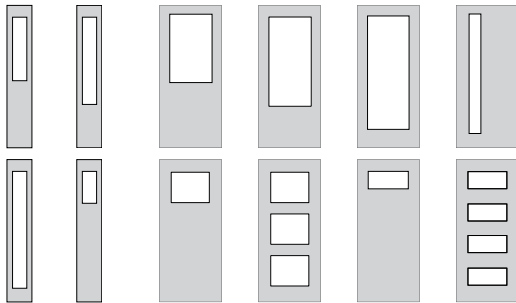

## PRIVACY



pear textured glass

Explore all available styles on page **114**

PEARL® 926 full glass in a VistaGrande® smooth fibreglass slab

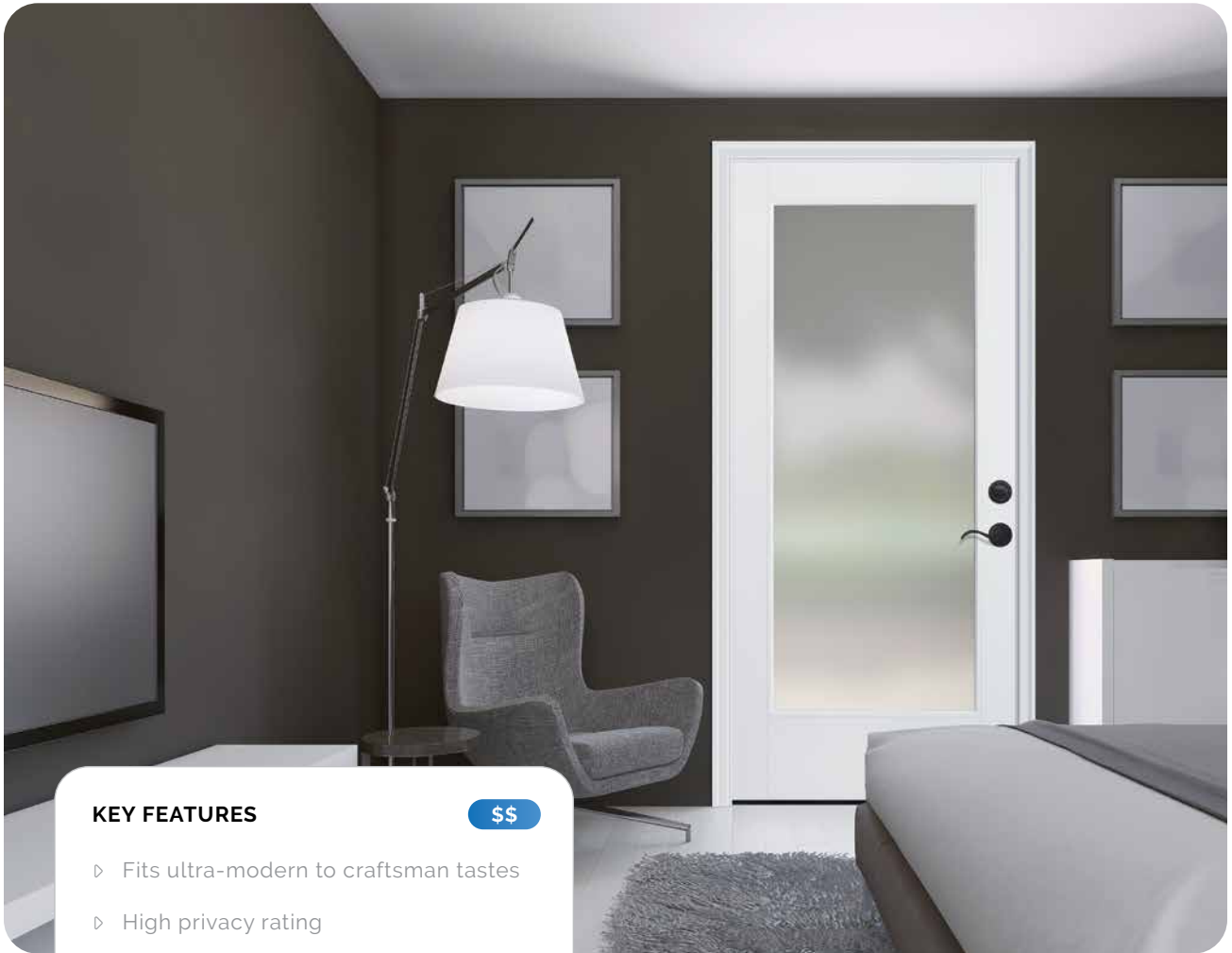

**KEY FEATURES** \$\$

- ▷ Fits ultra-modern to craftsman tastes
- ▷ High privacy rating
- ▷ Pearl textured glass

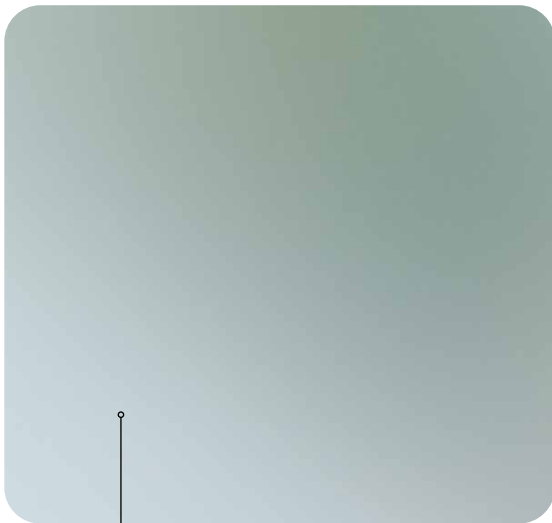

pearl textured glass

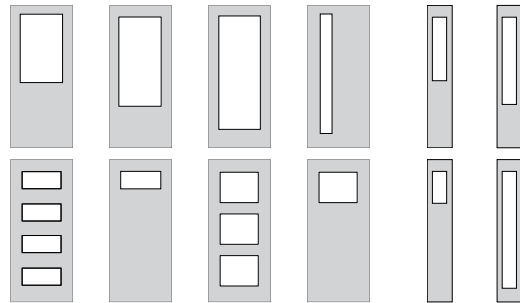

**PRIVACY**



Explore all available styles on page 114

Photos shown throughout this catalogue are for illustrative purposes only. This includes all displayed hardware, colours, finishes, and configurations, which may differ in availability and/or appearance on the final product. All doors come unfinished and do not include lockset/handle hardware unless otherwise specified.

# Pure

PURE 122 full glass in a smooth ribreglass slab

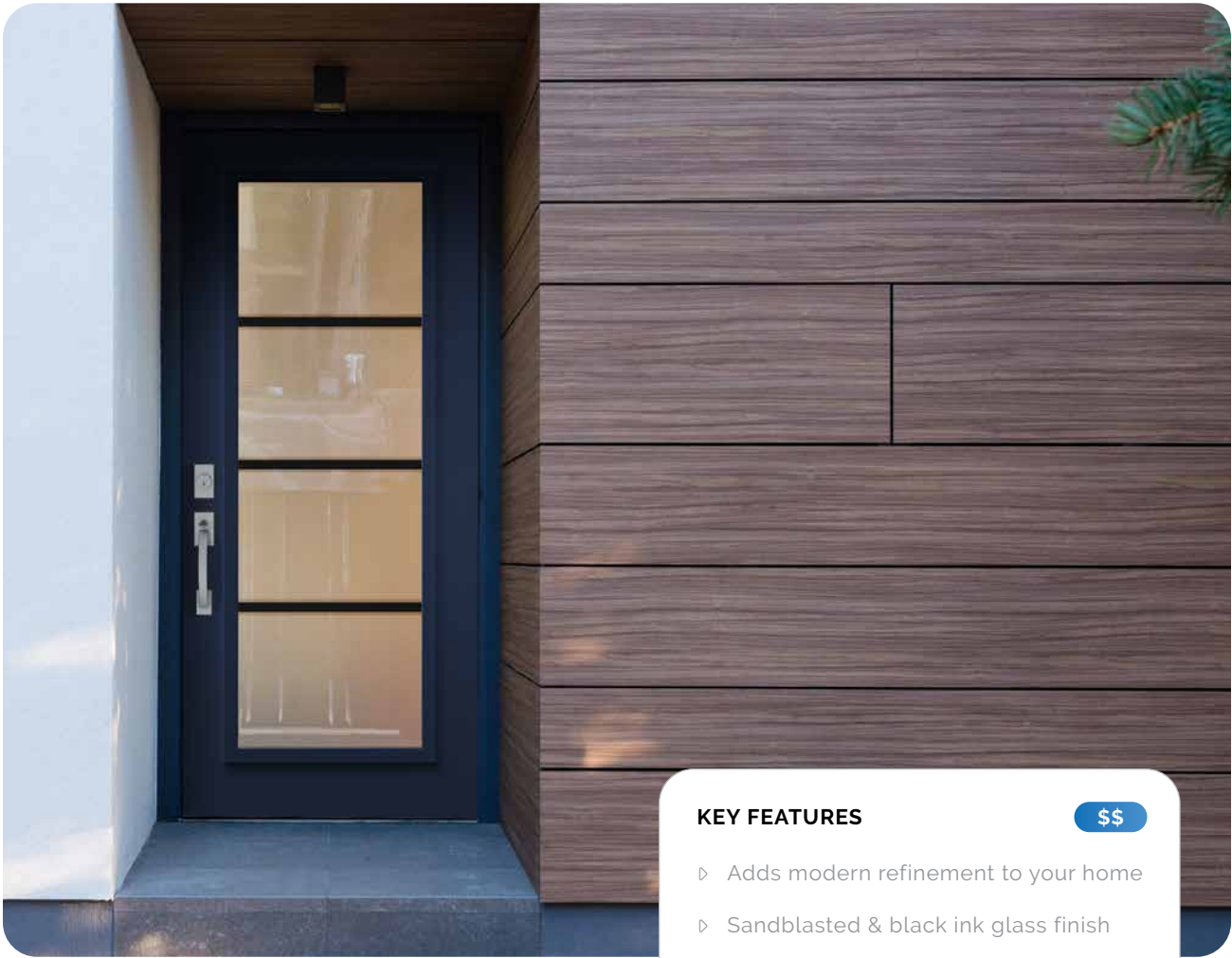

## KEY FEATURES

\$\$

- ▷ Adds modern refinement to your home
- ▷ Sandblasted & black ink glass finish
- ▷ Subtle clear glass lines

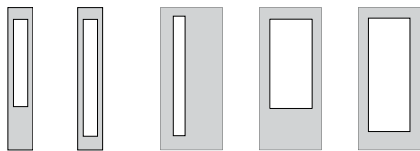

## PRIVACY



sandblasted  
ink finish

black ink  
finish

clear glass  
lines

Explore all available styles on page **114**



ROYSTON 122 full glass in a oak textured fibreglass slab with 152 full sidelites

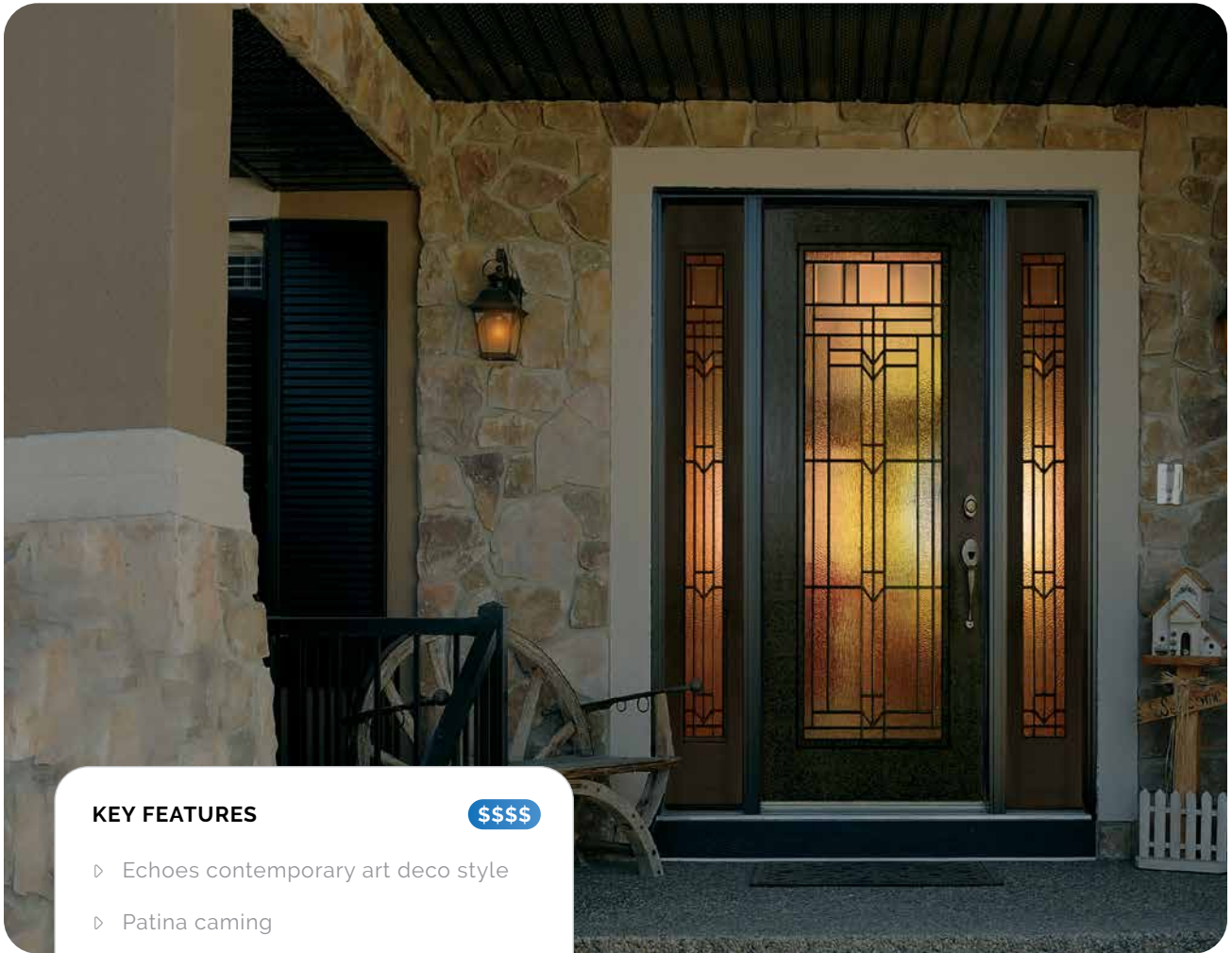

## KEY FEATURES

\$\$\$\$

- ▷ Echoes contemporary art deco style
- ▷ Patina caming
- ▷ Luminating reed & rain glass



clear  
beveled  
glass

granite  
textured  
glass

rain  
textured  
glass

patina  
caming

luminating  
reed  
glass

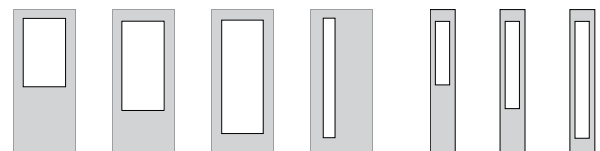

## PRIVACY

1 2 3 4 5 6 7 8 9 10

least obscure

most obscure

Explore all available styles on page **114**

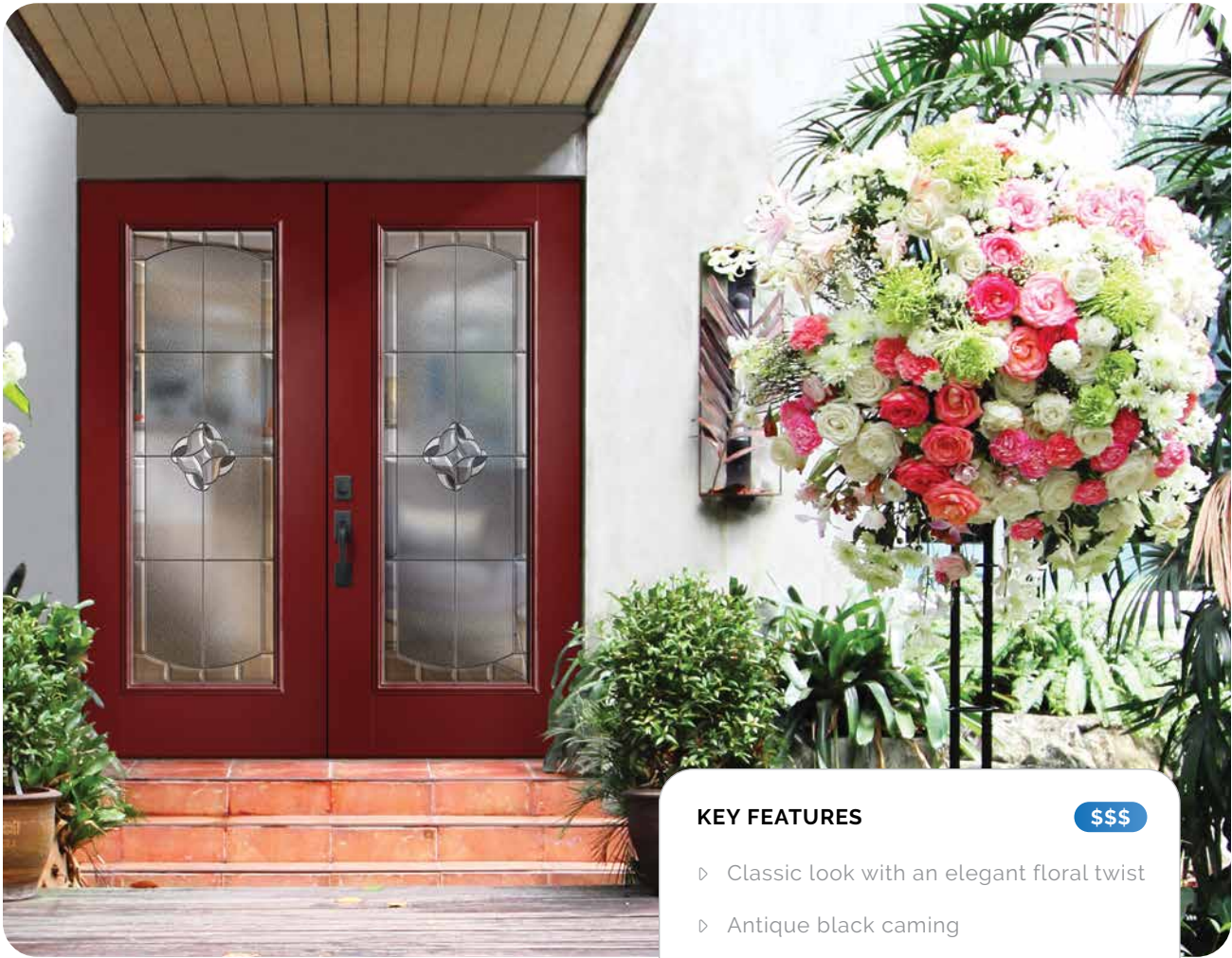

### KEY FEATURES

\$\$\$

- ▷ Classic look with an elegant floral twist
- ▷ Antique black caming
- ▷ Pale grey water glass accents

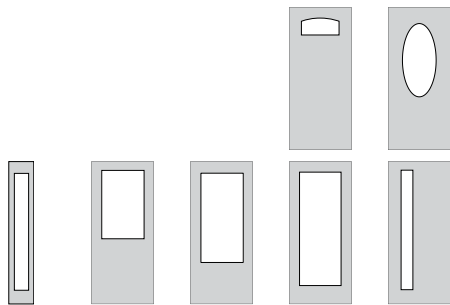

### PRIVACY

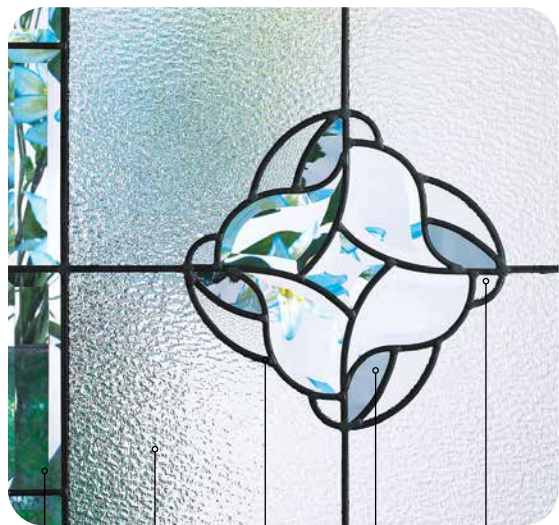

clear beveled glass granite textured glass antique black caming pale grey water glass pear textured glass

Explore all available styles on page **114**



SOFT 122 full glass in a steel slab with a 152 full sidelite



### KEY FEATURES

\$\$\$

- ▷ Unconventional upholstered pattern
- ▷ High privacy rating
- ▷ Soft textured glass

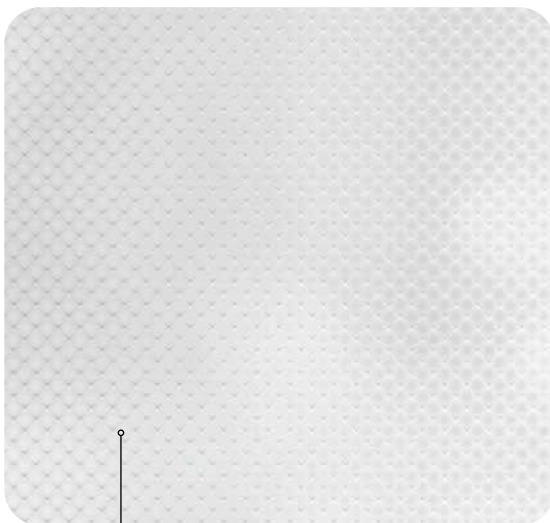

soft textured glass

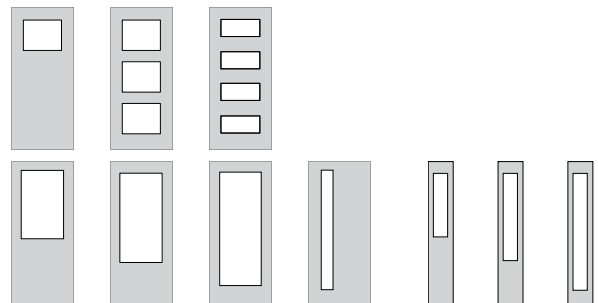

### PRIVACY



Explore all available styles on page **114**



# Textured & Clear

CLEAR 217 glass in a fir textured fiberglass slab with matching 617 sidelites and clear transom



## KEY FEATURES

\$\$

- ▷ Ultimate choice in versatility
- ▷ Available in dual or triple pane
- ▷ Add grilles or SDL (see page 103)

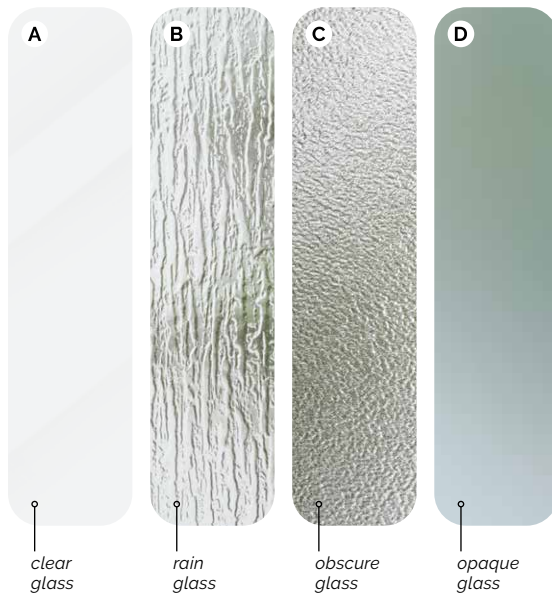
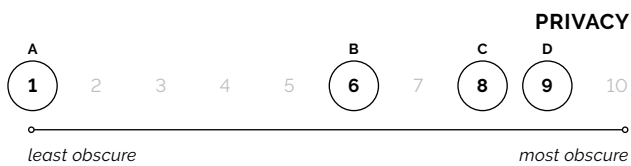
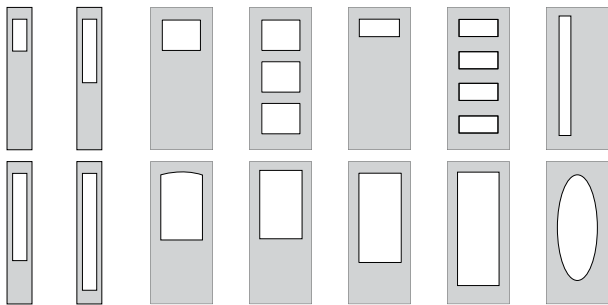

Explore all available styles on page 114

TRANSIT 122 full glass in a smooth fibreglass slab

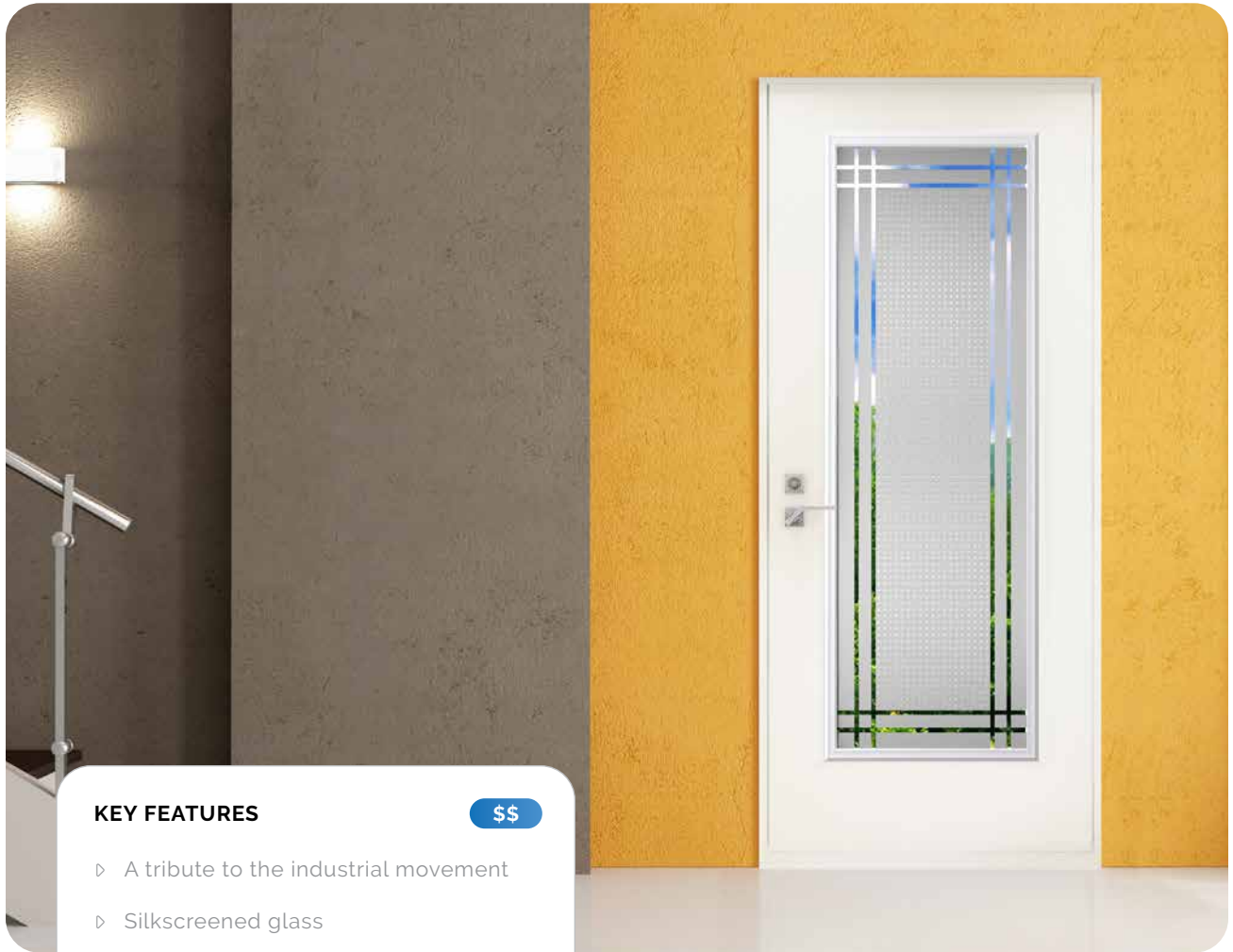

## KEY FEATURES

\$\$

- ▷ A tribute to the industrial movement
- ▷ Silkscreened glass
- ▷ Clear hatchwork pattern

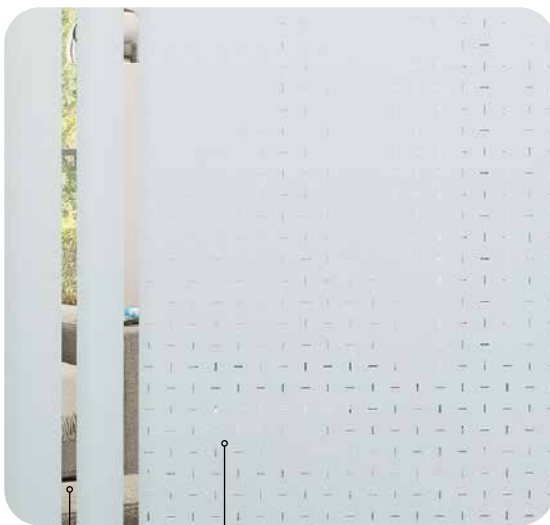

clear glass

sandblasted ink finish

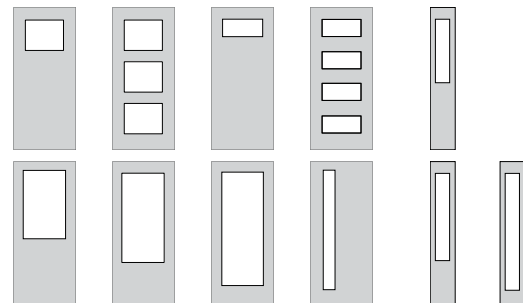

## PRIVACY



Explore all available styles on page **116**

# Venting & Internal Mini-Blinds

INTERNAL MINI-BLINDS 122 full glass in a smooth fiberglass door

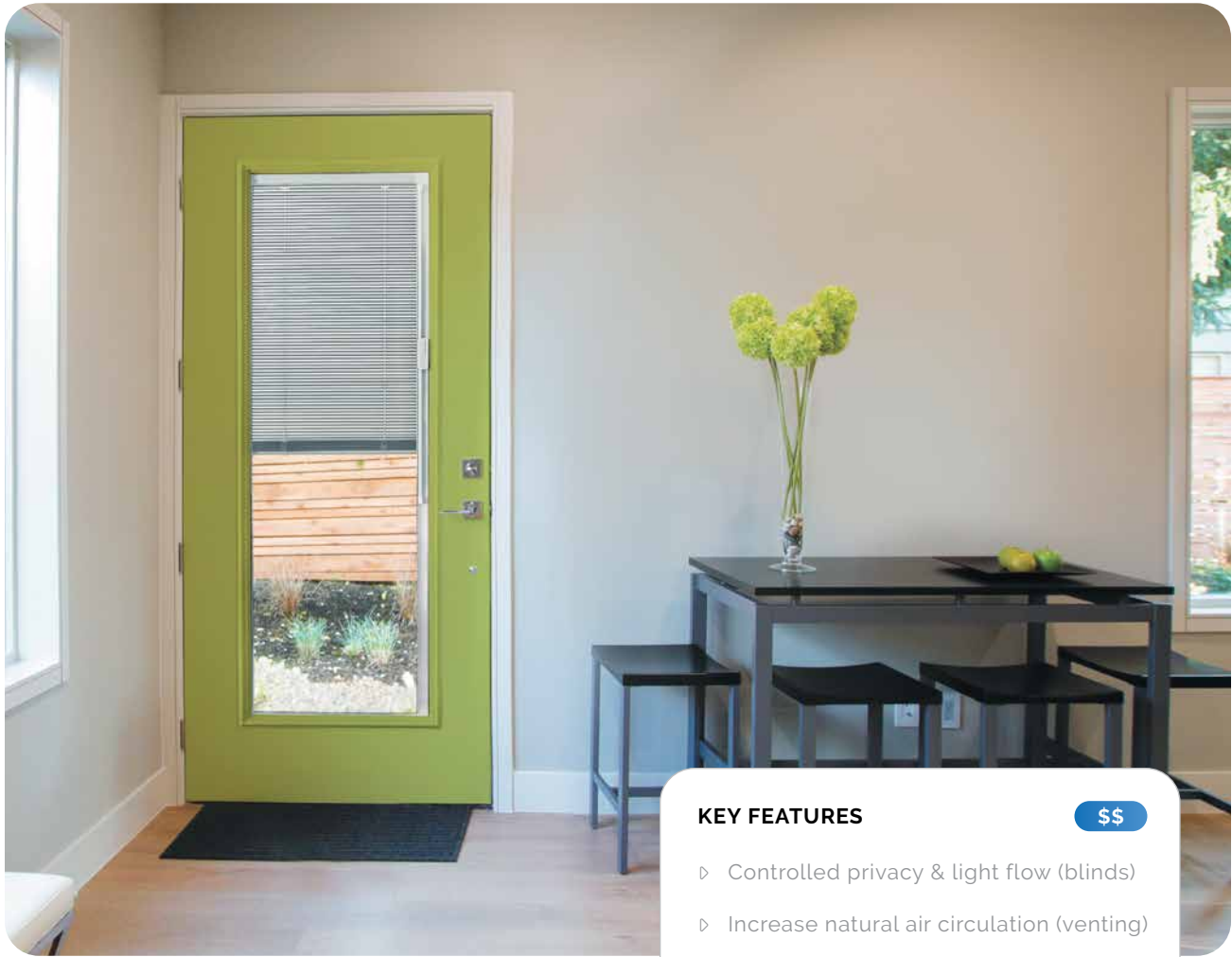

## KEY FEATURES

\$\$

- ▷ Controlled privacy & light flow (blinds)
- ▷ Increase natural air circulation (venting)
- ▷ Available with low-E (blinds & venting)

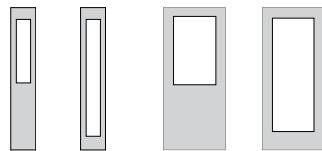

### PRIVACY



removable bug screen  
optional internal grilles



tilt, raise & lower operation  
enclosed venetian slats

Explore all available styles on page 116

**Note:** Internal blind inserts are not available in venting styles and do not have a raise/lower function on sidelite sizes. Venting inserts are not available in sidelite sizes.



VERSO 404 3/4 glass in a smooth fibreglass slab

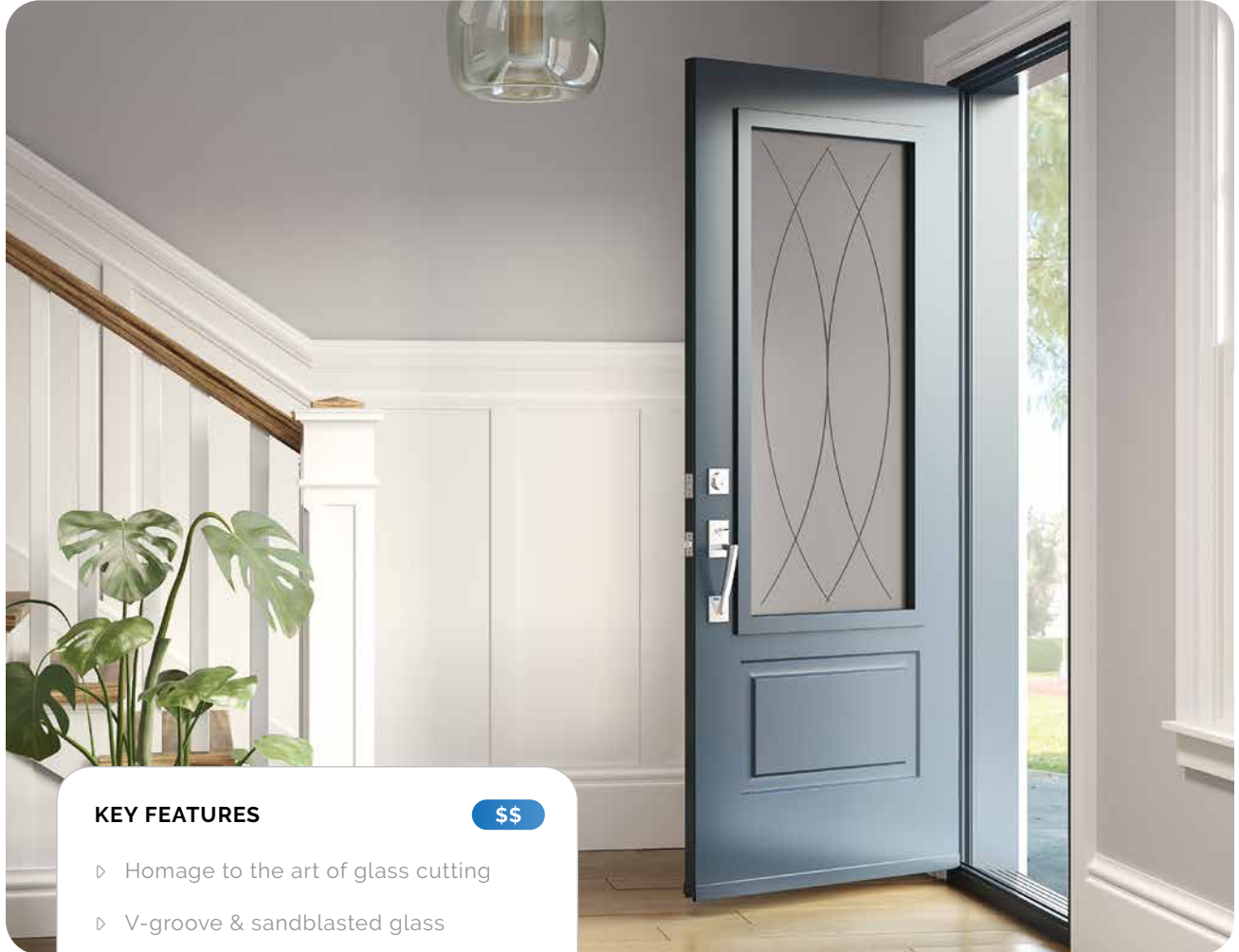

**KEY FEATURES** \$\$

- ▷ Homage to the art of glass cutting
- ▷ V-groove & sandblasted glass
- ▷ High privacy rating

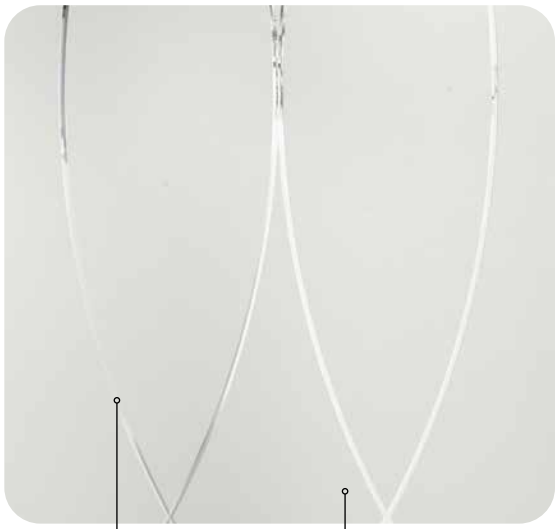

polished v-groove lines

sandblasted glass

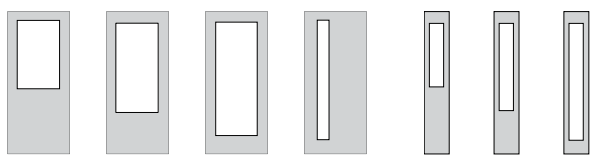

**PRIVACY**



Explore all available styles on page **116**

# Winchester



WINCHESTER 40 3/4 glass in a smooth fibreglass slab with clear glass transom

## KEY FEATURES

\$\$\$

- ▷ Classic style in it's simplest form
- ▷ Rich, contrasting mix of glass
- ▷ Patina caming

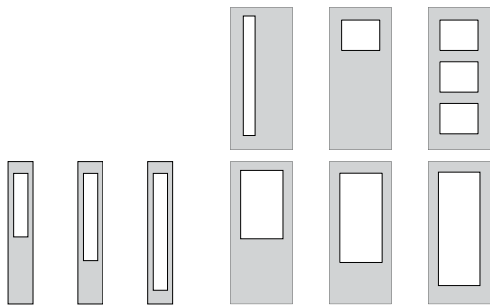

## PRIVACY



clear beveled glass

satin finish glass

patina caming

Explore all available styles on page 116

ZENITH 122 full glass in a smooth fibreglass slab

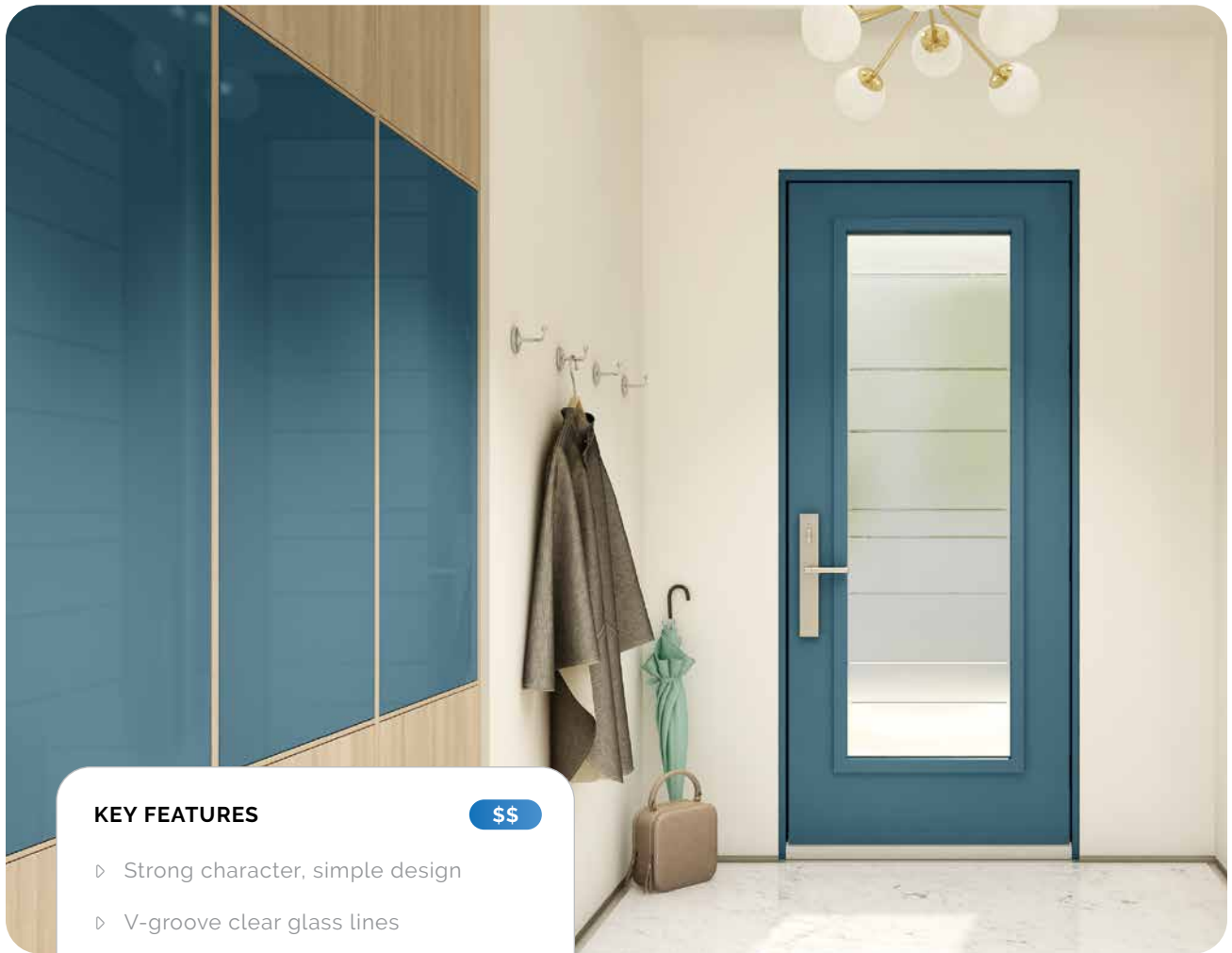

## KEY FEATURES

\$\$

- ▷ Strong character, simple design
- ▷ V-groove clear glass lines
- ▷ Sandblasted finish for privacy

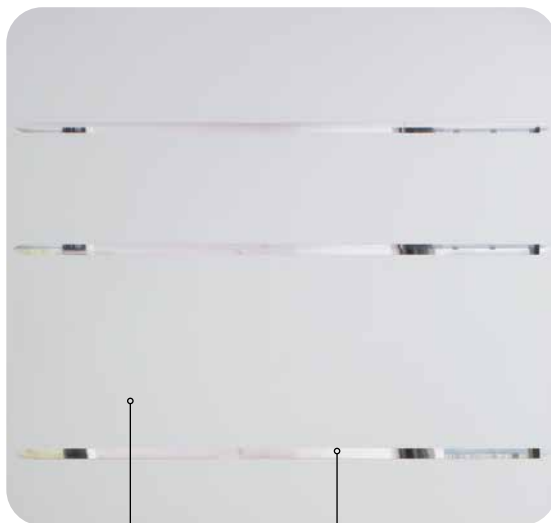

sandblasted glass

clear v-groove lines

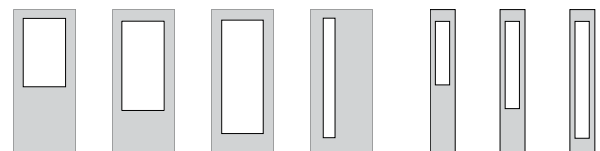

## PRIVACY



Explore all available styles on page **116**



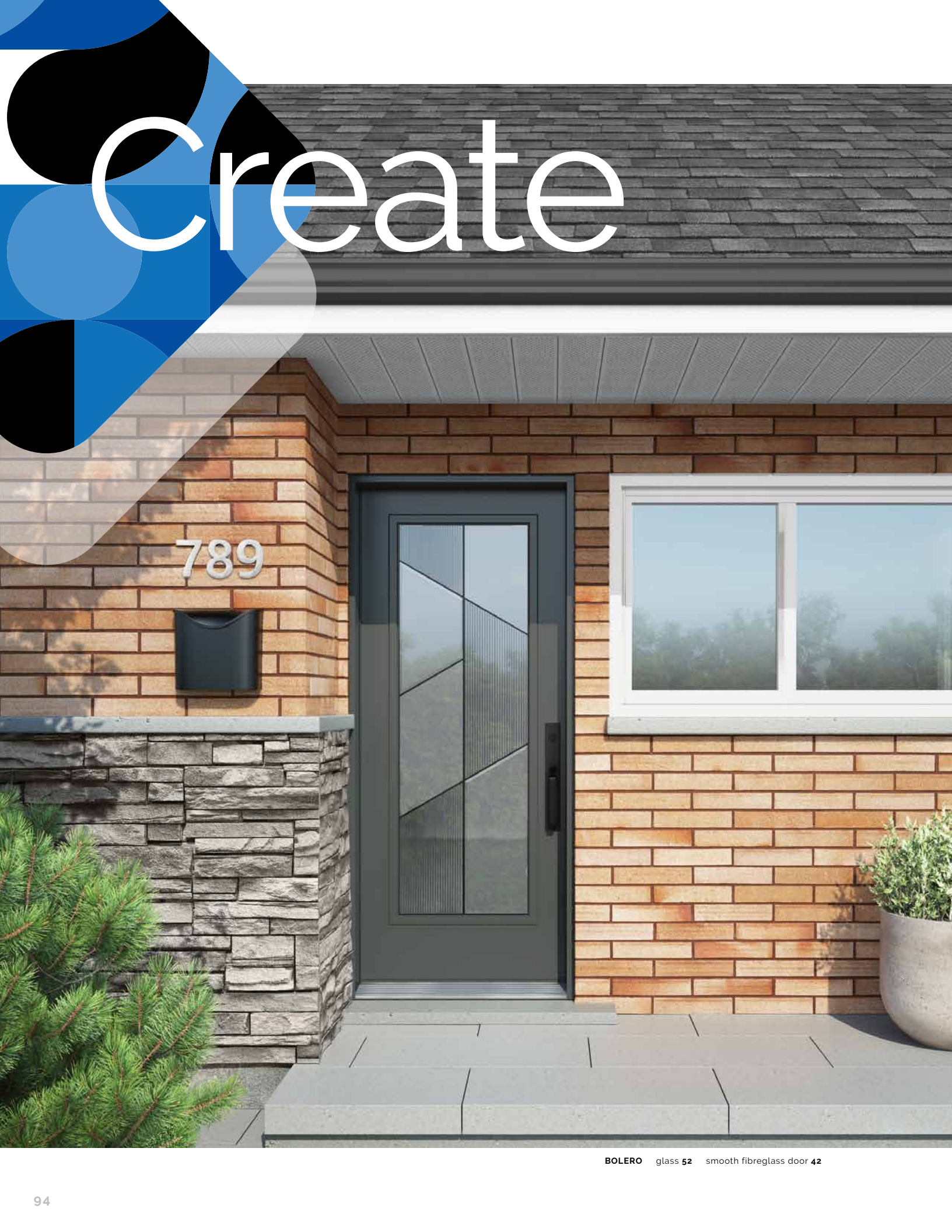

# create

789



**BOLERO** glass 52 smooth fibreglass door 42



## Create

96	Operating Styles
97	Handing & Swing
98	Fire Rated Door System
100	NAFS & ENERGY STAR®
101	Entry Door System
102	Multilock Hardware
103	Grilles & SDL
104	Brickmould, Hinges & Striker Plates
105	Door Slab & Frame Finishes
106	Style Matrix - Decorative Glass A-Z
118	Style Matrix - Craftsman Smooth
118	Style Matrix - Mid-Century Modern
119	Style Matrix - Panels
120	Style Matrix - VistaGrande®
121	Slab Sizing
124	Frame & Rough Opening Sizes
126	Measuring Your Door
127	Door Planner
128	Notes
130	Door Glass Size Code & Panel Legend
131	Index

# Operating Styles

## More than just the swing

In or out? Left or right? Single or double? A transom perhaps? Maybe a sidelite or two? The options are endless. Designing your door can be as simple as matching an existing door or as complex as a multi-part configuration. It's all up to you. Be bold. Be creative!

## Double & Garden Doors

Double and garden doors may seem similar, but there is one noticeable difference. Garden doors consist of one main operating door and one fixed or venting door with a stationary centre post. Double doors however, can be fully opened to create a single large opening. The centre post, known as an astragal, is attached to one of the two doors. The astragal post uses top and bottom flush-bolts to secure it into place when both doors are not in use.

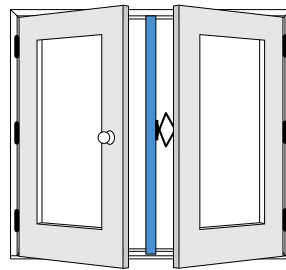

### GARDEN DOOR

*Left door slab is operating, right door slab is venting. Centre post is stationary.*

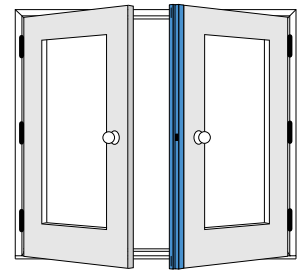

### DOUBLE DOOR

*Left door slab is operating, right door slab is inactive with centre post (astragal) attached.*

## Sidelites

Sidelites not only enhance the look and size of your door, but they can also add additional benefits. Using a full glass sidelite can increase the amount of sunlight that enters into your home while maximizing the overall width of your door. Full glass sidelites can also be customized to varying widths. Adding venting panel sidelites can help promote airflow and increase ventilation. Sidelites are available in hundreds of styles to perfectly and seamlessly match your door.

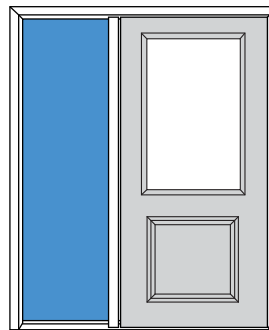

### FULL GLASS SIDELITE

*Clear or textured sealed units are glazed directly into the door frame and cannot be vented (door shown as an outswing).*

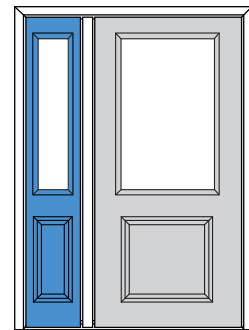

### PANEL SIDELITE

*12 or 14 inch door panels are either fixed into the door frame or vented out using a crank mechanism (door and sidelite shown as an outswing).*

## Transoms

Limited by width? Why not go higher? Transoms allow increased sunlight into your home while increasing beauty and elegance. Transoms are fully customizable with a large selection of shapes, sizes and clear and textured glass options.

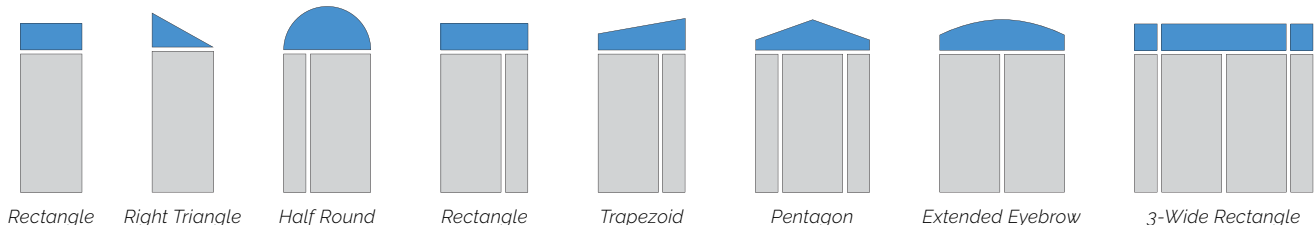

Rectangle

Right Triangle

Half Round

Rectangle

Trapezoid

Pentagon

Extended Eyebrow

3-Wide Rectangle

**Note:** Garden doors include an interior "in-frame" screen on the venting slab only. A sliding exterior screen is available on garden doors only when the following 3 conditions are met: 1) inswing configuration, 2) one slab is fixed, 3) 6-9/16" minimum jamb depth. Screens are not available on double door configurations. Venting sidelites may not meet current building codes for your area.



# Handing & Swing

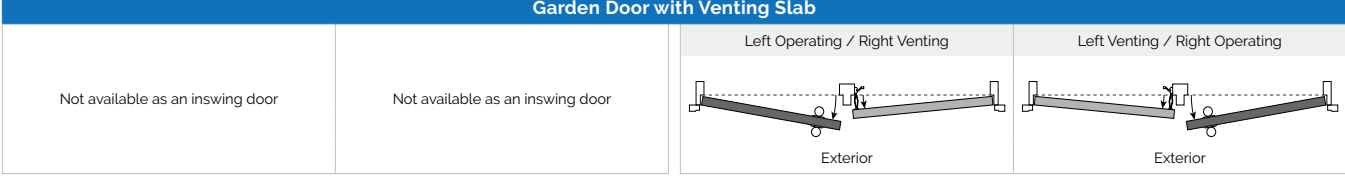
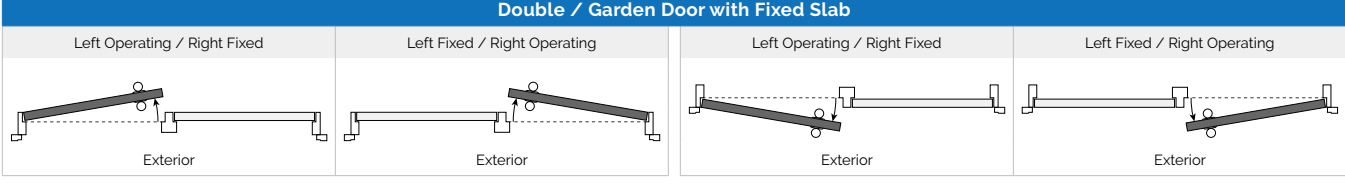
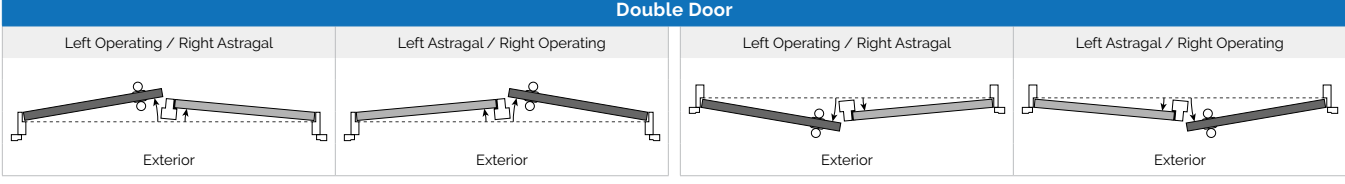
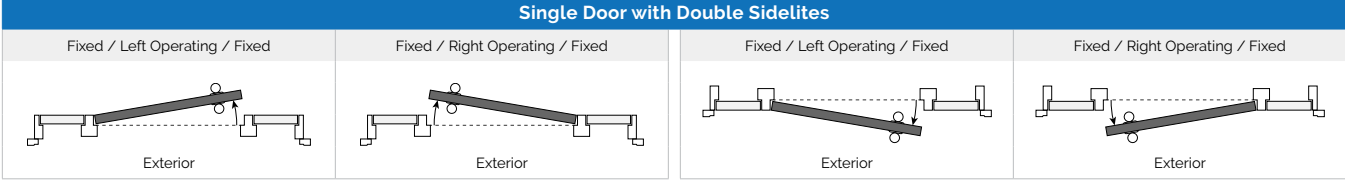
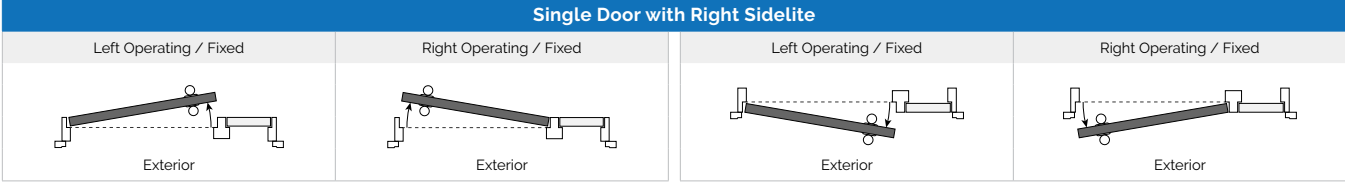
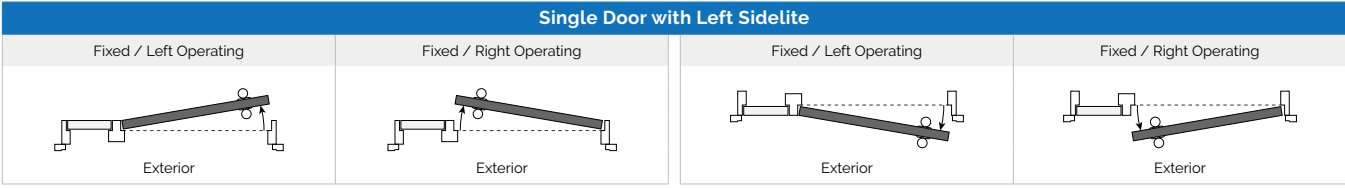
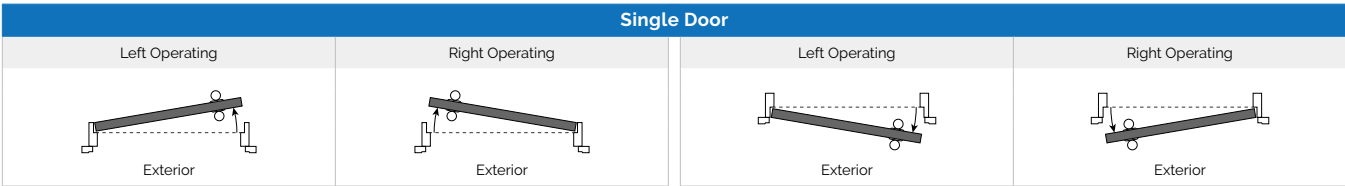
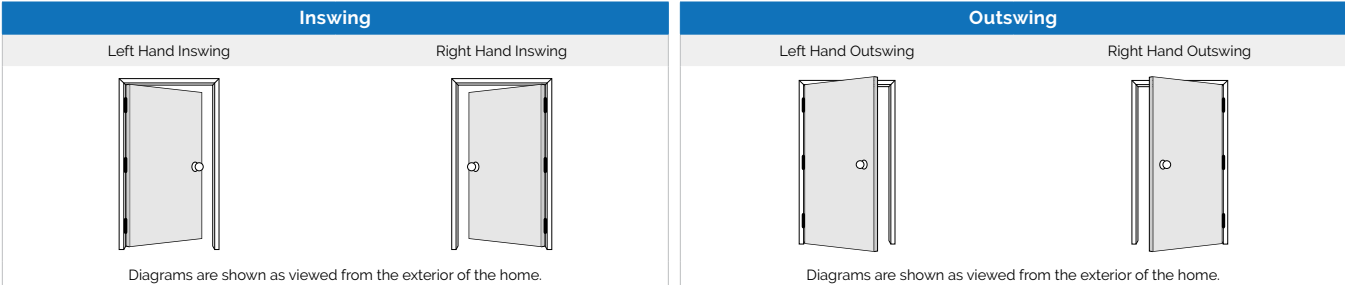

**Note:** Additional handing and swing options may be available depending on your door configuration. Talk to an All Weather at Home representative to help you design a door that works best for you.

# Fire Rated Door System

## The ultimate fire rated door system

Our 90-minute fire rated door system comes pre-hung and utilizes the innovative adjustable Fast-Frame® by Timely®. Fast-Frame's® advanced design adds a new dimension of flexibility and durability to our steel entry door line. Adjustable up to a full 1", the frame can accommodate almost any variation of wall construction. This easy-to-install, user-friendly, kerfed white galvanized steel door frame system is applicable to a full range of residential and commercial applications—wood or steel stud construction. Our fire rated door system is engineered to meet the most stringent code requirements including structural, impact and 90-minute fire ratings.

A 20-minute option is also available and includes a wood finger joint pine (FJP) jamb.

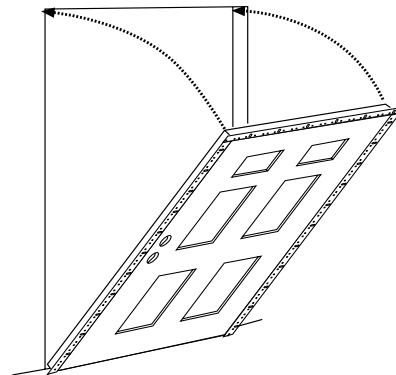

## Fast-Frame® Construction<sup>1</sup>

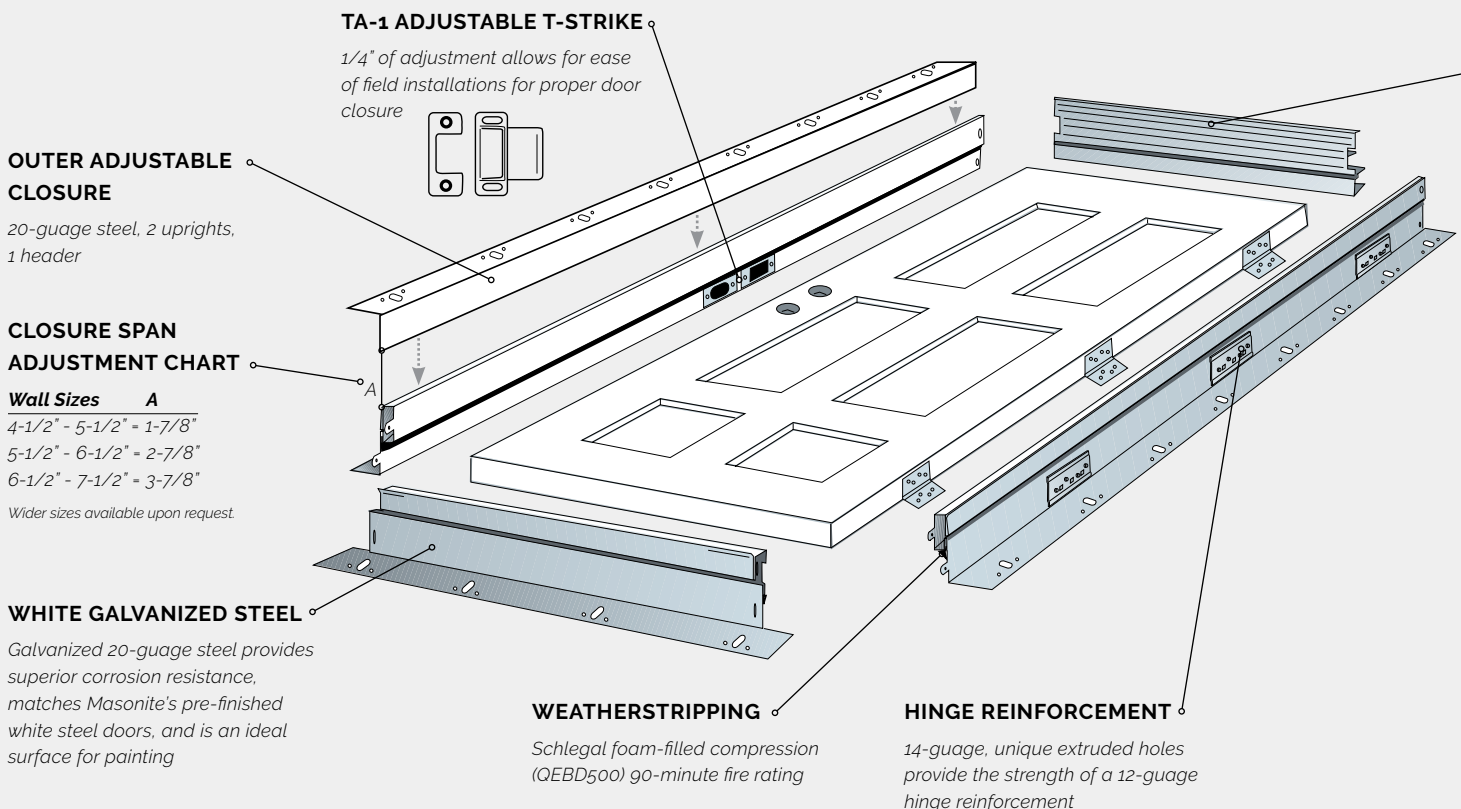

<sup>1</sup>Fast-Frame® is available on 90-minute fire rated door systems only.

**Note:** For more information on fire rating requirements and to order, please talk to an All Weather at Home representative. Extended lead times apply.

## Fire Labels

Our fire rated door systems include a 20 and 90-minute fire rating option. This includes all components of the door frame, steel door slab, hinges, and striker plates.



## Warranty

A 2 year limited manufacturer warranty against defects in materials and craftsmanship is included on all fire rated door systems.



## Closure Test

Fire rated door systems will close and latch from 18" if the following Fast-Frame<sup>®1</sup> components are used:

- ▷ QEBD500 compression weatherstripping
- ▷ factory sweep
- ▷ adjustable T-strike
- ▷ factory supplied sills
- ▷ self-closing hinges

## Door Styles

Both 20 and 90-minute options are available in a 6-panel steel skin slab. 90-minute doors also come with a steel flush slab option.

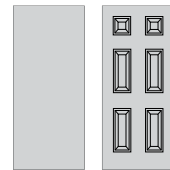

## Feature & Sizing Availability

	20 Minute	90 Minute
<b>Slab Construction</b>	Wood Edge	Steel Edge
<b>Jamb</b>	Finger Joint Pine (FJP)	Steel Fast-Frame <sup>®</sup>
<b>Glass Inserts</b>	No	No
<b>NAFS Compliance</b>	No	No
<b>Door Height</b>	6' 8"	6' 8" & 8' 0"
<b>Door Width</b>	2' 8", 3' 0"	2' 6", 2' 8", 2' 10", 3' 0"
<b>Frame Depth</b>	4-9/16", 6-9/16"	4-9/16", 5-5/8", 6-5/16"
<b>Door Swing</b>	Inswing Only	Inswing: (5-5/8" & 6-5/16") Outswing: (4-9/16")
<b>Door Slab Style</b>	6 Panel Only	6 Panel & Flush

### FAST-FRAME<sup>®</sup> SILLS<sup>1</sup>

#### STANDARD INSWING

Thermally broken - 5-5/8" width with optional extenders

**Note:** Not for use on outswing applications



#### BUMPER OUTSWING

4-9/16" width with integrated weather seal.

**Note:** Not for use on inswing applications.

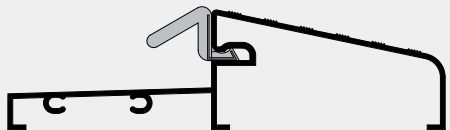

#### HANDICAP (ADA)

Double slope 4-9/16" & 6-9/16" widths 

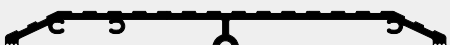

## Rough Opening Sizes

	Nominal Door Size	Rough Opening Size (wood stud)
<b>6'8" Height</b>	2'6" x 6'8"	31-1/4" x 81-3/8"
	2'8" x 6'8"	33-1/4" x 81-3/8"
	2'10" x 6'8"	35-1/4" x 81-3/8"
	3'0" x 6'8"	37-1/4" x 81-3/8"
<b>8'0" Height</b>	2'8" x 8'0"	33-1/4" x 97-3/8"
	2'10" x 8'0"	35-1/4" x 97-3/8"
	3'0" x 8'0"	37-1/4" x 97-3/8"

**Note:** All dimensions shown are for doors with a standard inswing sill. Deduct 13/16" for bumper, outswing or handicap compliant sills.

 **STRUCTURAL PERFORMANCE & IMPACT RATING:** Design pressure ratings are available for compliance with national, state and local wind load and/or missile requirements. Product tested for structural and impact performance in accordance with TAS 201, 202, and 203. Product approval available under the Florida Department of Community Affairs (FL10357). **Note:** Structural and Impact performance requires use of a hurricane grade 5/8" T-astagal for double doors.



# NAFS

## What is NAFS?

The North American Fenestration Standard (NAFS) is designed to combine the fenestration testing and ratings process previously done by organizations such as AAMA, WDMA and CSA, into a harmonized North American Standard. It has been incorporated into the National Building Code of Canada and implemented across Canadian provinces.

NAFS Certification requires stringent standards be met for:

- ▷ Air tightness
- ▷ Water penetration resistance
- ▷ Structural performance under wind loads
- ▷ Forced entry resistance

All Weather at Home offers NAFS tested and certified windows and doors, available in nearly every product series and configuration.\* Each NAFS certified product is clearly labeled, outlining the PG value and any specific ratings such as water and air resistance values.

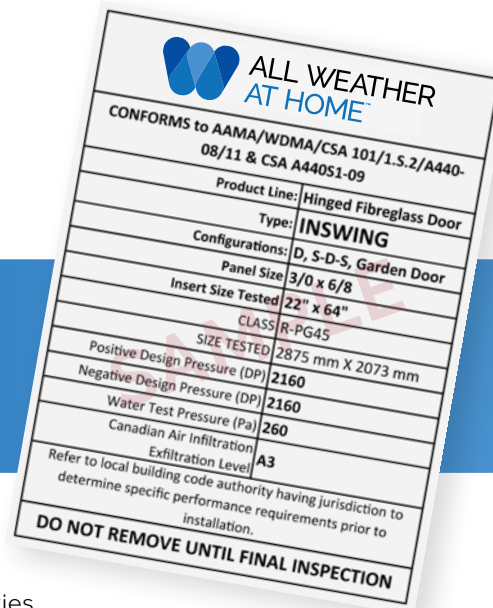

## Performance grade & class

Ratings are based on a combination of a product's structural properties and its ability to resist water. As a result, a single numeric rating is assigned to each product. This rating is called the **Performance Grade (PG)**.

NAFS has also categorized the application of fenestration products into four groups. Each of these groups is called a **Performance Class**. Each class requires products that meet a minimum performance grade.

The performance classes and applicable minimum performance grades are:

- R:** Residential (one and two family) - minimum PG15
- LC:** Light Commercial (low rise and multi-family dwellings) - minimum PG25
- CW:** Commercial Window (low rise and multi-family dwellings, higher loads and larger sizes) - minimum PG30
- AW:** Architectural Window (mid to high rise buildings, high exposure conditions) - minimum PG40

# ENERGY STAR®



ENERGY STAR® is a government backed program to help consumers identify energy efficient products. It is a voluntary program administered by Natural Resources Canada.

All Weather at Home products are labeled with an ENERGY STAR® label outlining product performance and zone ratings. Depending on the product and configuration, zone ratings will vary. Talk to an All Weather at Home customer service or sales representative or visit [allweatherathome.ca](http://allweatherathome.ca) for more information.

\*NAFS performance grade (PG) requirements can vary by region and/or terrain type. Not all options/configurations may meet your area's specific requirements. Check with an All Weather at Home sales representative to help determine which products will best suit your requirements. ENERGY STAR® is a registered trademark of the U.S. EPA and is administered in Canada by Natural Resources Canada.

# Entry Door System

## Now even tougher

How do you improve on an entry door system that boasts superior drainage, robust construction and an enhanced seal for overall performance and stability? You listen to customer feedback, review its performance in the field, and build it even better with plenty of cool new options. Combine that together and you have our NEW All Weather at Home entry door system. Our latest entry door design includes improved sealing and key new features to protect you from the elements more effectively than ever.



## Comfort in, weather out

Enhanced multilock, replaceable sill cover, and improved sealing, giving you greater protection from the elements. Our extended sill is designed to work with standard size aluminum storm doors.

*See page 102 for more details on our multilock system.*

## Composite jamb options

Optional low-maintenance smooth composite jamb offers higher durability and resists moisture, rot and mildew.

Available in white - or add jet black wrap for additional style.

## NAFS ready & certified<sup>2</sup>

To meet the stringent North American Fenestration Standards (NAFS), our doors come with the option to be fully NAFS certified.<sup>2</sup>

<sup>2</sup>NAFS certification available by request only at the time of order. NAFS performance grade (PG) requirements can vary by region and/or terrain type. Not all options/configurations may meet your area's specific requirements. Check with an All Weather at Home sales representative to help determine which products will best suit your requirements.

# Multilock Hardware

## The 3-point difference

To create the ultimate weather-proof seal, All Weather at Home offers a 3-point multilock door hardware system. This innovative locking system is smart, sophisticated, and packed with features making it the optimal choice in security and performance. These features include:

- ▷ 3-point hook and claw<sup>1</sup> mechanism on active hardware for a tighter seal
- ▷ Unique "Duo-Glide" lock mechanism. Superior to standard single drive systems, the "Duo-Glide" two-way action balances the lock system providing smoother, quieter, and easier operation. "Duo-Glide" allows for the lock points to engage in tension rather than compression thereby reducing stress on other elements of the lock system for longer life
- ▷ Anti-slam device for added safety and gasket protection
- ▷ Laminated stainless steel deadbolt with anti-saw pin
- ▷ Anti-back drive feature prevents tampering
- ▷ Latch wear strip prevents marring the centre of the striker plate
- ▷ 90 degree thumb-turn deadbolt operation located above the handle

Through superior craftsmanship, materials and handle styles, our multi-point hardware takes the guesswork out of selecting the right hardware for your door. With a wide selection of premium finishes, you'll be sure to perfectly match your door with the rest of your home's finishes.



3-Point "Hook & Claw"  
Multilock Assembly

## MULTILOCK HARDWARE STYLE OPTIONS



## MULTILOCK HARDWARE FINISH OPTIONS



<sup>1</sup> Shoot bolt system is used for passive hardware on a double doors with astragal post.

<sup>2</sup> Athena and Stuttgart handles are available in flat black, satin nickel and oil rubbed bronze finishes only.

<sup>3</sup> Satin nickel is available on Athena and Stuttgart handle styles only.



## Take your door to the next level

Make a lasting impression and an unforgettable look by adding internal grilles or SDL's to your entry door. Internal grilles and SDL's add a touch of elegance and give your door a traditional feel.

## Internal Grilles

Internal grilles are installed between panes of glass, leaving the exposed interior and exterior glass smooth and easy to clean. Grilles provide a beautiful look of divided light, while being virtually maintenance free.

### GRILLE FINISHES

	Black	Gold	Lead	Patina	White	Wicker
5/16"	•	•	•	•	•	•
5/8"	•	•		•	•	•
1"		•		•	•	•
1" Split (white/black)	•					
5/8" Georgian		•	•	•	•	•



### GRILLE SPLIT FINISHES



### GRILLE PATTERNS<sup>4</sup>

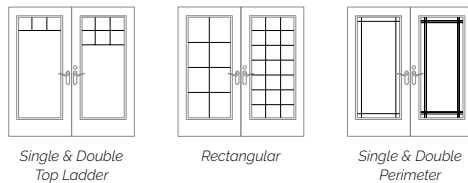

### GRILLE SIZES

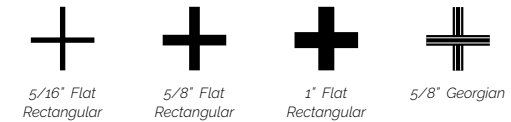

## SDL (Simulated Divided Lites)

Simulated Divided Lites (SDL) are installed on the exterior and interior of the glass surface to simulate the look of divided panes of glass. Traditionally, individually divided panes of glass reduce energy efficiency by creating multiple seams and joints for every pane. With the simulated design, you get the beautiful look of divided glass, without sacrificing energy efficiency.

### SDL PATTERNS<sup>5</sup>

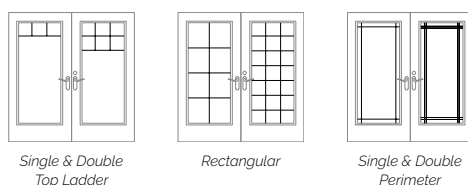

### SDL SIZES



<sup>4</sup> Available on clear and textured glass only. Not available on decorative glass.

<sup>5</sup> Available on clear and opaque textured glass only. Not available on decorative glass.

# Brickmould, Hinges & Striker Plates

## Brickmould

Brickmould is the moulding that fills the gap between where the door and wall meet. Our aluminum 3/4" slimline brickmould includes an integrated nail flange, while our 2" renovation option boasts a discreet screw channel and cover, making it the perfect choice for replacing your existing door.

In addition to our aluminum brickmould options, we offer primed wood brickmould in 3 different profiles.



## Hinges & Striker Plates

Premium 4-1/2" hinges with a 5/8" radius are included on all doors in a variety of finishes to perfectly compliment the rest of your hardware. For a smoother and quieter swing, upgrade to ball bearing hinges or choose self-closing to ensure your door always remains closed. Our doors also include adjustable striker plates to ensure easy maintenance and the best possible door seal.

### HINGES



### STRIKER PLATES



### HINGE & STRIKER PLATE FINISHES



	Black	Brass	Brushed Brass	Oil Rubbed Bronze	Satin Chrome	Stainless Steel
<b>Hinges</b>						
Regular Hinge		•			•	
Ball Bearing Hinge	•		•	•	•	•
Self-closing Hinge	•	•		•	•	
<b>Striker Plates</b>						
Double Adjustable Striker Plate	•	•			•	
Single Adjustable Striker Plate	•	•			•	
Single Striker Plate (Multilock)					•	

**Note:** Doors with both deadbolt and lockset drilling include a double adjustable striker plate while doors with only lockset drilling include a single adjustable striker plate. Doors with multilock hardware do not come with adjustable striker plates.

# Door Slab & Frame Finishes

## Pre-Painted & Pre-Stained Door Slab Finishes

Offering superior durability, extended service life and exceptional chemical resistance, our pre-painted and stained doors offer a professionally-finished solution. Available on smooth fibreglass and woodgrain textured fibreglass door slabs, choose from a variety of stunning factory-applied paint and stain finishes.<sup>1</sup>

### PAINT FINISHES

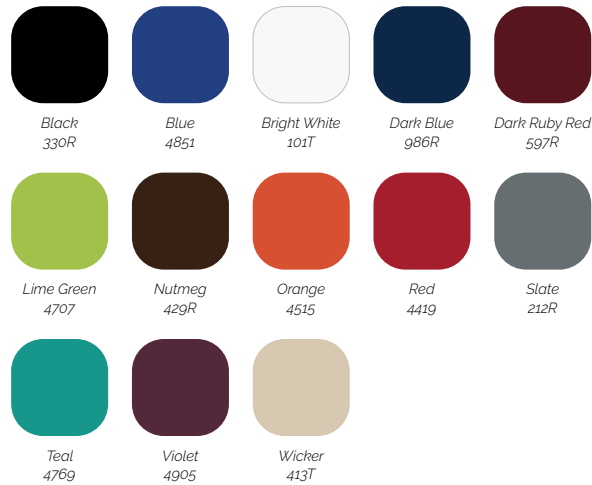

### STAIN FINISHES



## Black Pre-Painted Steel Doors

A factory-painted black exterior easily creates a dramatic statement to your entryway, while the white pre-painted interior perfectly compliments any home's decor. Available on 2 panel, 6 panel and flush steel doors.

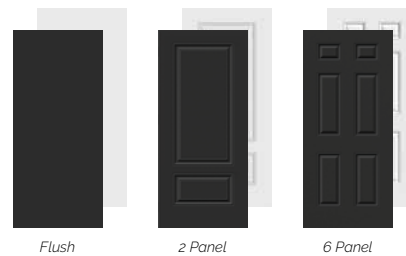

## Door Frame Metal Cladding Finishes

All door frames come standard with a metal clad exterior which protects the door frame while adding colour and a seamless finish.

### EXTERIOR METAL CLAD COLOURS<sup>2</sup>

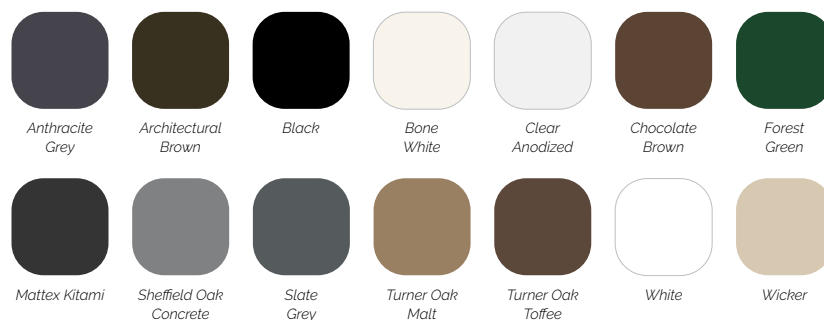

<sup>1</sup> Actual colours may vary. Available on fibreglass doors only. Finishing includes all 6 sides of door slab and glass insert frames (if applicable). Finishing is not offered on door frame components, including exterior frame and interior jamb.





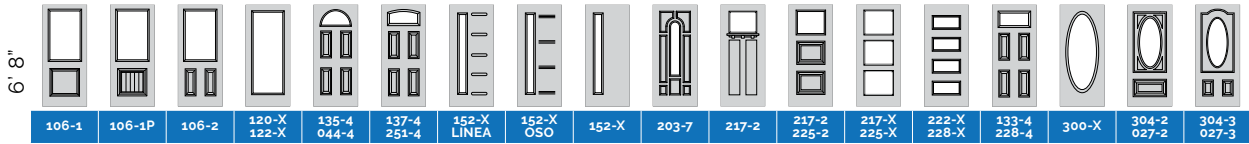

<sup>2</sup> Available with a black exterior and white interior only. Glass insert frames come unfinished (if applicable).

<sup>3</sup> Actual colours may vary. Premium colours have an additional upcharge including a colour setup fee and may have an extended lead time. Options shown do not apply to steel adjustable Fast-Frame®.



# Style Matrix | Decorative Glass | A-C



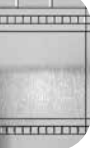

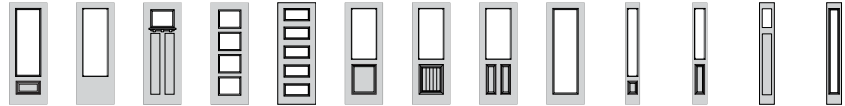

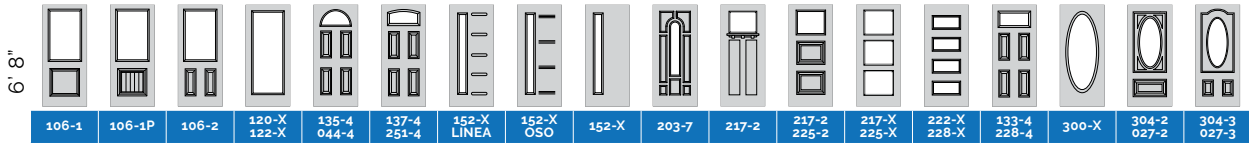

		106-1	106-1P	106-2	120-X 122-X	135-4 044-4	137-4 251-4	152-X LINEA	152-X OSO	152-X	203-7	217-2	217-2 225-2	217-X 225-X	222-X 228-X	133-4 228-4	300-X	304-2 027-2	304-3 027-3		
 Adelaide	Mahogany		•	•	•																
	Fir																				
	Oak			•	•					•											
	Smooth	•	•	•	•						•										
	Steel	•	•	•	•			•	•	•											
 Alys	Mahogany		•	•	•													•			
	Fir																				
	Oak			•	•		•				•								•		
	Smooth	•	•	•	•		•				•								•		
	Steel	•	•	•	•		•	•	•	•									•		
 Arima	Mahogany		•	•	•																
	Fir																				
	Oak			•	•						•										
	Smooth	•	•	•	•						•				•						
	Steel	•	•	•	•			•	•	•				•	•						
 Azur	Mahogany		•	•	•																
	Fir																				
	Oak			•	•						•										
	Smooth	•	•	•	•						•				•						
	Steel	•	•	•	•			•	•	•				•	•						
 Bolero	Mahogany				•																
	Fir																				
	Oak				•																
	Smooth				•																
	Steel				•																
 Cachet	Mahogany		•	•																	
	Fir																				
	Oak			•		•															
	Smooth	•	•	•		•															
	Steel	•	•	•		•															
 Celeste	Mahogany		•	•	•																
	Fir																				
	Oak			•	•						•										
	Smooth	•	•	•	•						•				•						
	Steel	•	•	•	•			•	•	•				•	•						
 Chanelle	Mahogany		•	•	•																
	Fir																				
	Oak			•	•																
	Smooth	•	•	•	•										•						
	Steel	•	•	•	•									•	•						

						<span style="writing-mode: vertical-rl; transform: rotate(180deg);">810"</span> 													
404-1	404-2	129-1	151-X 152-X	450-1	617-1	122-1	122-X	217-2	217-X	222-X 228-X	404-1	404-1P	404-2	810-X	151-1	450-1	617-1	852-X 853-X	
•		•	•	•									•			•			
•		•	•	•							•	•	•			•			
•	•	•	•	•									•			•			
•		•	•	•									•			•			
•		•	•	•									•			•			
•		•	•	•									•			•			
•		•	•	•									•			•			
•		•	•	•									•			•			
•		•	•	•									•			•			
•		•	•	•									•			•			
•		•	•	•									•			•			
•		•	•	•									•			•			
•		•	•	•									•			•			
•		•	•	•									•			•			
•		•	•	•									•			•			
•		•	•	•									•			•			
•		•	•	•									•			•			

# Style Matrix | Decorative Glass | C-E



	106-1	106-1P	106-2	120-X 122-X	135-4 044-4	137-4 251-4	152-X LINEA	152-X OSO	152-X	203-7	217-2	217-2 225-2	217-X 225-X	222-X 228-X	133-4 228-4	300-X	304-2 027-2	304-3 027-3	
 Chelsea®	Mahogany		•	•	•														
	Fir																		
	Oak			•	•				•										
	Smooth	•	•	•	•				•										
	Steel	•	•	•	•		•	•	•										
 Chord®	Mahogany		•	•	•													•	
	Fir										•								
	Oak			•	•				•					•	•				
	Smooth	•	•	•	•				•		•		•	•	•				
	Steel	•	•	•	•		•	•	•		•	•	•	•	•				
 Crosswalk	Mahogany		•	•	•														
	Fir																		
	Oak			•	•				•										
	Smooth	•	•	•	•				•										
	Steel	•	•	•	•		•	•	•										
 Cruz™	Mahogany		•	•	•														
	Fir																		
	Oak			•	•				•										
	Smooth	•	•	•	•				•										
	Steel	•	•	•	•		•	•	•										
 Cuzco®	Mahogany		•	•	•														
	Fir																		
	Oak			•	•				•										
	Smooth	•	•	•	•				•										
	Steel	•	•	•	•		•	•	•										
 Element®	Mahogany		•	•	•														
	Fir										•								
	Oak			•	•	•			•										
	Smooth	•	•	•	•	•			•		•		•						
	Steel	•	•	•	•	•	•	•	•		•	•	•						
 Entropy	Mahogany				•														
	Fir																		
	Oak				•														
	Smooth				•														
	Steel				•														
 Equation	Mahogany																		
	Fir																		
	Oak																		
	Smooth	•	•	•	•				•										
	Steel	•	•	•	•		•	•	•										





404-1 404-2 129-1 151-X  
152-X 450-1 617-1

8' 0"

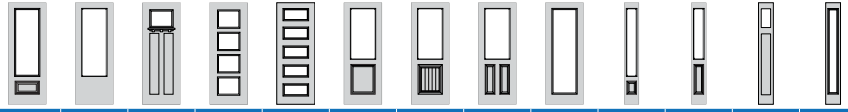

122-1 122-X 217-2 217-X 222-X  
228-X 404-1 404-1P 404-2 810-X 151-1 450-1 617-1 852-X  
853-X

	.		.	.	.	
			.	.	.	
	.		.	.	.	
	.	.	.	.	.	

.							.			.	.		
									.	.	.		
.						.	.		.	.	.		
	.						.		.	.	.		

			.	.	.	.
			.	.	.	.
			.	.	.	.
.	.	.	.	.	.	.

.							.			.	.		
							.			.	.		
.		.	.	.	.	.	.		.	.	.	.	
	.					.	.		.	.	.	.	.

.			.	.	.	
			.	.	.	
.			.	.	.	
.	.	.	.	.	.	

.							.	.	.	.	.		.
							.	.	.	.	.	.	.
.						.	.		.	.	.	.	.
	.						.	.	.	.	.	.	.

.			.	.	.	
			.	.	.	
.			.	.	.	
.	.	.	.	.	.	

.							.			.	.		
							.			.	.		
.						.	.		.	.	.		
	.						.		.	.	.		

.			.	.	.	
			.	.	.	
.			.	.	.	
.	.	.	.	.	.	

.							.			.	.		
							.			.	.		
.						.	.		.	.	.		
	.						.		.	.	.		

.			.	.	.	.
			.	.	.	.
.			.	.	.	.
.	.	.	.	.	.	.

.							.			.	.		
			.	.			.			.	.	.	
.		.	.	.		.	.		.	.	.	.	.
	.				.		.		.	.	.	.	.

			.	.	.	
			.	.	.	
			.	.	.	
			.	.	.	

.							.			.	.		.
							.			.	.		.
.						.	.		.	.	.		.
	.						.		.	.	.		.

.			.	.	.	
.			.	.	.	
.	.	.	.	.	.	

.							.			.	.		
							.			.	.		
.						.	.		.	.	.		
	.						.		.	.	.		

# Style Matrix | Decorative Glass | F-L

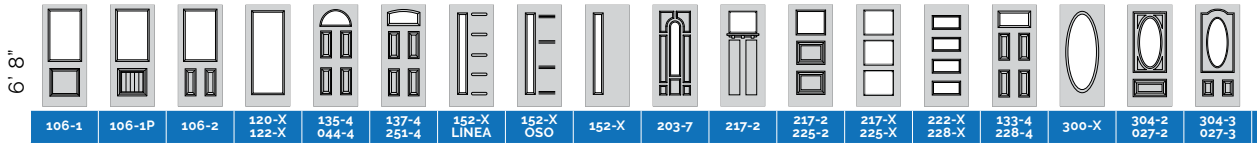

Fluid

Mahogany		•	•	•															
Fir																			
Oak			•	•				•					•						
Smooth	•	•	•	•				•				•	•						
Steel	•	•	•	•			•	•	•			•	•	•					



Focus

Mahogany		•	•	•														•	
Fir										•									
Oak			•	•				•					•	•					
Smooth	•	•	•	•				•		•		•	•	•					
Steel	•	•	•	•			•	•	•	•	•	•	•	•	•				



Frontier®

Mahogany		•	•															•	
Fir										•									
Oak			•					•					•	•					
Smooth	•	•	•					•		•		•	•	•					
Steel	•	•	•				•	•	•	•	•	•	•	•	•				



Georgian™

Mahogany		•	•	•														•	
Fir																			
Oak			•	•				•											
Smooth	•	•	•	•				•										•	
Steel	•	•	•	•			•	•	•										•



Harlow

Mahogany		•	•	•															
Fir																			
Oak			•	•				•											
Smooth	•	•	•	•				•											
Steel	•	•	•	•			•	•	•										



Hollister

Mahogany		•	•	•															
Fir																			
Oak			•	•				•											
Smooth	•	•	•	•				•											
Steel	•	•	•	•			•	•	•										





Kordella®

Mahogany		•	•	•															
Fir																			
Oak			•	•				•											
Smooth	•	•	•	•				•											
Steel	•	•	•	•			•	•	•										



Lexington







Mahogany		•	•	•															
Fir																			
Oak			•	•				•				•		•					
Smooth	•	•	•	•				•				•		•					
Steel	•	•	•	•			•	•	•			•		•					

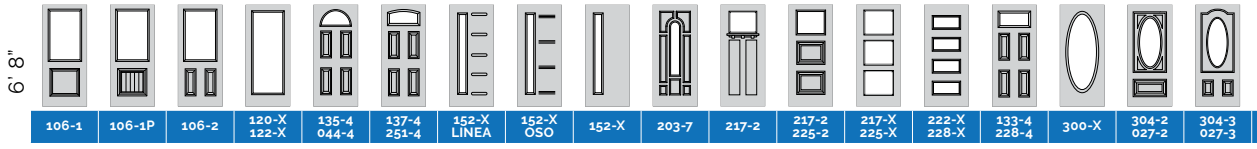

																			
404-1	404-2	129-1	151-X 152-X	450-1	617-1	122-1	122-X	217-2	217-X	222-X 228-X	404-1	404-1P	404-2	810-X	151-1	450-1	617-1	852-X 853-X	
•		•	•	•		•							•			•			
		•	•	•									•			•			
•		•	•	•		•		•	•	•	•	•	•			•			
•	•	•	•	•			•		•	•			•			•			
•		•	•	•		•							•		•	•			
			•										•			•	•		
•			•			•		•	•	•	•	•	•			•	•		
•			•										•			•	•		
•	•		•										•			•	•		
•		•	•	•									•			•	•		
			•										•			•	•		
•			•			•							•			•	•		
•			•										•			•	•		
•	•		•										•			•	•		
•		•	•	•									•			•	•		
•			•										•			•	•		
•			•										•			•	•		
•	•		•										•			•	•		

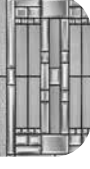

# Style Matrix | Decorative Glass | L-O







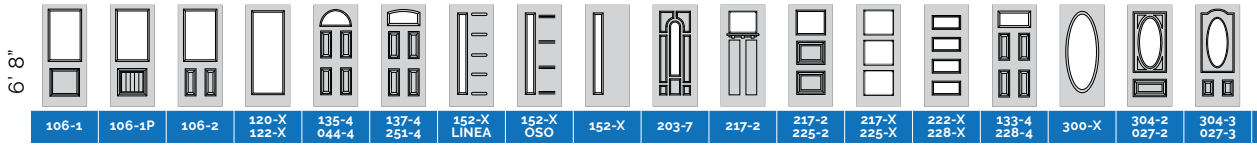

		106-1	106-1P	106-2	120-X 122-X	135-4 044-4	137-4 251-4	152-X LINEA	152-X OSO	152-X	203-7	217-2	217-2 225-2	217-X 225-X	222-X 228-X	133-4 228-4	300-X	304-2 027-2	304-3 027-3		
 Louisbourg	Mahogany		•	•	•																
	Fir																				
	Oak			•	•					•											
	Smooth	•	•	•	•					•											
	Steel	•	•	•	•			•	•	•											
 Marco®	Mahogany		•	•															•		
	Fir											•									
	Oak			•						•					•	•					
	Smooth	•	•	•						•		•		•	•	•					
	Steel	•	•	•				•	•	•		•	•	•	•	•					
 Mistral	Mahogany		•	•	•																
	Fir																				
	Oak			•	•																
	Smooth	•	•	•	•									•							
	Steel	•	•	•	•								•	•							
 Modena	Mahogany		•	•	•																
	Fir																				
	Oak			•	•					•											
	Smooth	•	•	•	•					•											
	Steel	•	•	•	•			•	•	•											
 Monterey	Mahogany		•	•	•																
	Fir																				
	Oak			•	•					•											
	Smooth	•	•	•	•					•											
	Steel	•	•	•	•			•	•	•											
 Naples®	Mahogany		•	•	•						•								•		
	Fir											•									
	Oak			•	•					•					•	•					
	Smooth	•	•	•	•					•		•		•	•	•					
	Steel	•	•	•	•			•	•	•	•	•	•	•	•	•					
 Nuando	Mahogany				•																
	Fir																				
	Oak				•																
	Smooth				•																
	Steel				•																
 Opal	Mahogany		•	•	•																
	Fir																				
	Oak			•	•					•											
	Smooth	•	•	•	•					•											
	Steel	•	•	•	•			•	•	•											

																			
404-1	404-2	129-1	151-X 152-X	450-1	617-1	122-1	122-X	217-2	217-X	222-X 228-X	404-1	404-1P	404-2	810-X	151-1	450-1	617-1	852-X 853-X	
•		•	•	•		•							•				•		
		•	•	•									•				•		
•		•	•	•		•					•	•	•				•		
•	•	•	•	•			•						•				•		
•		•	•	•		•							•				•	•	
		•	•	•				•	•	•	•	•	•				•	•	
•		•	•	•		•							•				•	•	
		•	•	•									•				•	•	
•		•	•	•		•							•				•	•	
		•	•	•									•				•	•	
•		•	•	•		•							•				•	•	
		•	•	•									•				•	•	
•		•	•	•		•							•				•	•	
		•	•	•									•				•	•	
•		•	•	•		•							•				•	•	
		•	•	•									•				•	•	
•		•	•	•		•							•				•	•	
		•	•	•									•				•	•	
•		•	•	•		•							•				•	•	
		•	•	•									•				•	•	
•		•	•	•		•							•				•	•	
		•	•	•									•				•	•	
•		•	•	•		•							•				•	•	
		•	•	•									•				•	•	
•		•	•	•		•							•				•	•	
		•	•	•									•				•	•	
•		•	•	•		•							•				•	•	
		•	•	•									•				•	•	
•		•	•	•		•							•				•	•	
		•	•	•									•				•	•	
•		•	•	•		•							•				•	•	
		•	•	•									•				•	•	
•		•	•	•		•							•				•	•	
		•	•	•									•				•	•	

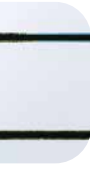
# Style Matrix | Decorative Glass | P-T

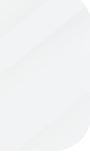

	106-1	106-1P	106-2	120-X 122-X	135-4 044-4	137-4 251-4	152-X LINEA	152-X OSO	152-X	203-7	217-2	217-2 225-2	217-X 225-X	222-X 228-X	133-4 228-4	300-X	304-2 027-2	304-3 027-3	
 Panama®	Mahogany		•	•	•					•								•	
	Fir																		
	Oak			•	•	•			•										
	Smooth	•	•	•	•	•			•									•	
	Steel	•	•	•	•	•	•	•	•	•									•
 Pear	Mahogany		•	•	•													•	
	Fir										•								
	Oak			•	•				•					•	•				
	Smooth	•	•	•	•				•		•		•	•	•				
	Steel	•	•	•	•		•	•	•	•	•	•	•	•	•	•			
 Pearl®	Mahogany		•	•	•													•	
	Fir										•								
	Oak			•	•				•					•	•				
	Smooth	•	•	•	•				•		•		•	•	•				
	Steel	•	•	•	•		•	•	•	•	•	•	•	•	•	•			
 Pure	Mahogany				•														
	Fir																		
	Oak				•				•										
	Smooth				•				•										
	Steel				•		•	•	•										
 Royston	Mahogany		•	•	•														
	Fir																		
	Oak			•	•				•										
	Smooth	•	•	•	•				•										
	Steel	•	•	•	•		•	•	•										
 Rozet™	Mahogany		•	•	•														•
	Fir																		
	Oak			•	•	•			•										
	Smooth	•	•	•	•	•			•										•
	Steel	•	•	•	•	•	•	•	•										•
 Soft	Mahogany		•	•	•														
	Fir																		
	Oak			•	•				•					•					
	Smooth	•	•	•	•				•				•	•					
	Steel	•	•	•	•		•	•	•			•	•	•					
 Textured & Clear	Mahogany		•	•	•													•	
	Fir										•								
	Oak			•	•	•			•					•	•			•	
	Smooth	•	•	•	•	•			•		•		•	•	•			•	
	Steel	•	•	•	•	•	•	•	•	•	•	•	•	•	•	•			•





404-1   404-2   129-1   151-X  
152-X   450-1   617-1

8"0"

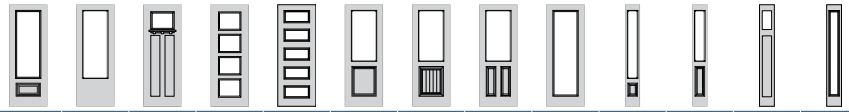

122-1   122-X   217-2   217-X   222-X  
228-X   404-1   404-1P   404-2   810-X   151-1   450-1   617-1   852-X  
853-X

•			•	•	
			•	•	
•			•	•	
•	•		•	•	

•		•	•	•	
		•	•	•	•
•		•	•	•	•
•	•	•	•	•	•

•		•	•	•	
		•	•	•	•
•		•	•	•	•
•	•	•	•	•	•

•			•	•	
			•	•	
•			•	•	
•	•		•	•	

•		•	•	•	
		•	•	•	
•		•	•	•	
•	•	•	•	•	

•			•		
			•		
•			•		
•	•		•		

•		•	•	•	
		•	•	•	
•		•	•	•	
•	•	•	•	•	

•		•	•	•	
		•	•	•	•
•		•	•	•	•
•	•	•	•	•	•

•									•	•	•	•		•
									•	•	•	•		•
•						•	•		•	•	•	•		•
	•								•	•	•	•		•

•									•		•	•		
									•		•	•		
•		•	•	•	•	•	•		•		•	•	•	•
	•			•	•	•	•		•		•	•	•	•

•									•			•		
									•			•		
•		•	•	•	•	•	•	•	•			•	•	•
	•			•	•	•	•		•			•	•	•

•									•			•		
									•			•		
•						•	•		•			•		
	•								•			•		

•									•			•		
									•			•		
•								•	•			•		
	•								•			•		

•									•		•			
									•		•			
•								•	•			•		
	•								•			•		

•									•	•		•		•
									•	•		•		•
•				•	•	•	•		•	•		•		•
	•			•	•	•	•		•	•		•		•

•									•	•		•		•
									•	•		•		•
•		•	•	•	•	•	•		•	•		•	•	•
	•			•	•	•	•		•	•		•	•	•

# Style Matrix | Decorative Glass | T-Z

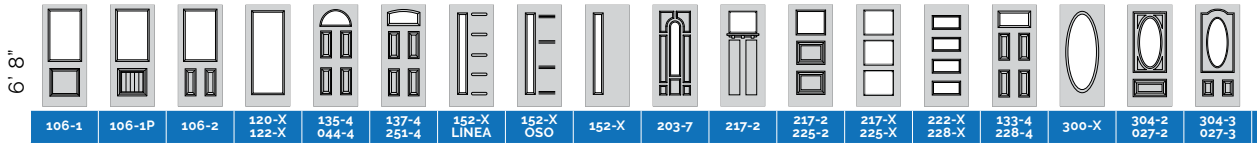

	106-1	106-1P	106-2	120-X 122-X	135-4 044-4	137-4 251-4	152-X LINEA	152-X OSO	152-X	203-7	217-2	217-2 225-2	217-X 225-X	222-X 228-X	133-4 228-4	300-X	304-2 027-2	304-3 027-3	
<b>Transit</b>	Mahogany		•	•	•												•		
	Fir																		
	Oak			•	•				•					•	•				
	Smooth	•	•	•	•				•				•	•	•				
	Steel	•	•	•	•			•	•	•			•	•	•	•			
<b>Venting &amp; Blinds</b>	Mahogany		•	•	•														
	Fir																		
	Oak			•	•				•*										
	Smooth	•	•	•	•				•*										
	Steel	•	•	•	•			•*	•*	•*									
<b>Verso</b>	Mahogany		•	•	•														
	Fir																		
	Oak			•	•				•										
	Smooth	•	•	•	•				•										
	Steel	•	•	•	•			•	•	•									
<b>Winchester</b>	Mahogany		•	•	•														
	Fir																		
	Oak			•	•				•										
	Smooth	•	•	•	•				•				•						
	Steel	•	•	•	•			•	•	•			•	•					
<b>Zenith</b>	Mahogany		•	•	•														
	Fir																		
	Oak			•	•				•										
	Smooth	•	•	•	•				•										
	Steel	•	•	•	•			•	•	•									



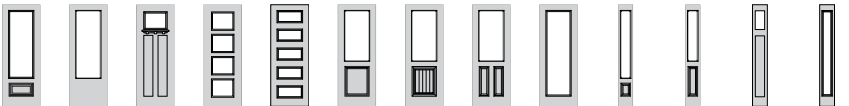



\*Not available as a venting insert. Available as an internal blind insert only.

																			
404-1	404-2	129-1	151-X 152-X	450-1	617-1	122-1	122-X	217-2	217-X	222-X 228-X	404-1	404-1P	404-2	810-X	151-1	450-1	617-1	852-X 853-X	
•		•	•	•		•							•				•		
		•	•	•									•				•		
•		•	•	•		•		•	•	•	•	•	•				•		
•	•	•	•	•			•		•	•			•				•		
			•*	•*															
			•*	•*															
			•*	•*											•*				
			•*	•*											•*				
•		•	•	•		•							•			•	•		
		•	•	•									•			•	•		
•		•	•	•		•							•			•	•		
•	•	•	•	•			•						•			•	•		
•		•	•	•									•				•		
		•	•	•									•				•		
•		•	•	•		•							•			•	•		
		•	•	•									•				•		
•		•	•	•		•							•			•	•		
•	•	•	•	•			•						•				•		





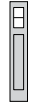
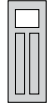
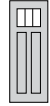

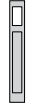
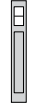
\*Not available as a venting insert. Available as an internal blind insert only.















# Style Matrix | Craftsman Smooth













		6'8"					8'0"				
											
		1 Lite	3 Lite	6 Lite	1 Lite	2 Lite	1 Lite	3 Lite	6 Lite	1 Lite	2 Lite
Clear	Smooth	•			•						
	SDL		•	•		•		•	•		•



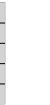





# Style Matrix | Mid-Century Modern



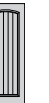







		6'8"				8'0"		
								
		223	806	808	151	223	806	808
Cross Reed	Smooth	•	•	•	•	•	•	•
	Steel	•	•	•	•	•	•	•
Narrow Reed	Smooth	•	•	•	•	•	•	•
	Steel	•	•	•	•	•	•	•
Sable	Smooth	•	•	•	•	•	•	•
	Steel	•	•	•	•	•	•	•
Sand Blasted	Smooth	•	•	•	•	•	•	•
	Steel	•	•	•	•	•	•	•
Sea Spray	Smooth	•	•	•	•	•	•	•
	Steel	•	•	•	•	•	•	•

# Style Matrix | Panels

6'8"													
	1 Shaker	2 Shaker	2P Arch	2 Arch	1P Square	Flush	2 Hollister	2 Square	3 Arch	3 Equal	3 Craftsman	6	8
Barrington Sierra			•										
Rustic Mahogany			•	•	•			•					
Cherry - Grooved						•							
Cherry - Stainless													
Mahogany			•									•	•
Fir	•	•									•		
Oak						•						•	
Smooth	•	•	•			•		•			•	•	
Steel			•	•		•	•	•	•	•	•	•	•
Steel (black ext.)						•	•					•	

6'8"												
	SOHO	VOG	OSO	Linea	C500	C501	C528	C536	C601	C602	C604	C605
Barrington Sierra												
Rustic Mahogany												
Cherry - Grooved					•	•	•	•				
Cherry - Stainless									•	•	•	•
Mahogany												
Fir												
Oak												
Smooth												
Steel	•	•	•	•								
Steel (black ext.)												

8'0"										
	1 Shaker	2 Shaker	1P Arch	2P Arch	1P Square	Flush	2P Square	2 Square	3 Craftsman	6
Barrington Sierra				•						
Rustic Mahogany			•	•	•		•			
Cherry - Grooved						•				
Cherry - Stainless										
Mahogany										•
Fir	•	•								
Oak						•				•
Smooth	•	•		•		•		•		•
Steel						•				•
Steel (black ext.)										

8'0"										
	SOHO	VOG	C500	C501	C528	C536	C608	C609	C611	C612
Barrington Sierra										
Rustic Mahogany										
Cherry - Grooved			•	•	•	•				
Cherry - Stainless							•	•	•	•
Mahogany										
Fir										
Oak										
Smooth										
Steel	•	•								
Steel (black ext.)										

# Style Matrix | VistaGrande®

		6' 8"								8' 0"							
		120 122	120 122	426	426	152	152	450	450	810 820 826	810 820 826	926	926	852	852	151	151
Chord®	Smooth	•	•	•	•	•	•	•	•	•	•	•	•	•	•	•	•
	Fir	•	•	•	•	•	•	•	•	•	•	•	•	•	•	•	•
Clear	Smooth	•	•	•	•	•	•	•	•	•	•	•	•	•	•	•	•
	Fir	•	•	•	•	•	•	•	•	•	•	•	•	•	•	•	•
Mini-Blinds	Smooth	•					•			•		•		•		•	
	Fir	•					•			•		•		•		•	
Pearl	Smooth	•	•	•	•	•	•	•	•	•	•	•	•	•	•	•	•
	Fir	•	•	•	•	•	•	•	•	•	•	•	•	•	•	•	•
Pearl®	Smooth	•	•	•	•	•	•	•	•	•	•	•	•	•	•	•	•
	Fir	•	•	•	•	•	•	•	•	•	•	•	•	•	•	•	•

## VistaGrande® SDL



*3-1/2" 4 lite'*    
 *3-1/2" 3 lite'*    
 *1-1/8" 3 lite ladder*    
 *1-1/8" 3 lite ladder*    
 *1-1/8" 6 lite rectangular*    
 *1-1/8" 10 lite rectangular*    
 *1-1/8" 4 lite rectangular*    
 *1-1/8" 6 lite rectangular*

NOTE: Availability may vary. Not all options shown. 1-1/8" SDL is only available with clear glass. 3-1/2" SDL is available as indicated in the matrix above. Rectangular patterns are available from 2-12 lites depending on glass and slab size. Please ask an All Weather at Home representative or authorized dealer for a list of all available options.

# Slab Sizing

## BARRINGTON® SIERRA® MAHOGANY TEXTURED FIBREGLASS



	2P BSP
6'8"	3'0"
8'0"	3'0", 3'6"

## CONTEMPORARY CHERRY TEXTURED FIBREGLASS

Stainless Steel Lines



	C601	C608	C602	C609	C604	C611	C605	C612
6'8"	2'10", 3'0", 3'6"		2'10", 3'0", 3'6"		2'10", 3'0", 3'6"		2'10", 3'0", 3'6"	
8'0"		2'10", 3'0", 3'6"		2'10", 3'0", 3'6"		2'10", 3'0", 3'6"		2'10", 3'0", 3'6"

Grooved Lines

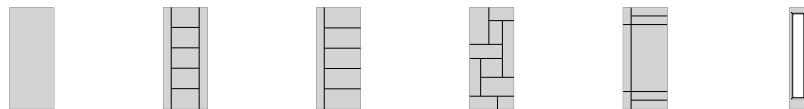

	C499	C500	C501	C528	C536	C498
6'8"	2'8", 2'10", 3'0", 3'6"	2'8", 2'10", 3'0", 3'6"	2'8", 2'10", 3'0", 3'6"	2'10", 3'0"	2'8", 2'10", 3'0", 3'6"	1'0", 1'2"
8'0"	2'8", 2'10", 3'0", 3'6"	2'8", 2'10", 3'0", 3'6"	2'8", 2'10", 3'0", 3'6"	2'10", 3'0", 3'6"	2'8", 2'10", 3'0", 3'6"	1'0", 1'2"
Glass Sizes	151, 152, 852					151, 152, 852

## CRAFTSMAN SMOOTH FIBREGLASS



	2 Panel Smooth Craftsman	1 Panel Smooth Craftsman Sidelite
6'8"	3'0"	1'0"
8'0"	3'0"	1'0"
Glass Sizes	217	152

## FIR TEXTURED FIBREGLASS



	1 Shaker	2 Shaker	3 Craftsman	Craftsman Sidelite
6'8"	2'8", 2'10", 3'0"	2'8", 2'10", 3'0"	2'8", 2'10", 3'0"	1'0", 1'2"
8'0"	2'8", 2'10", 3'0"	2'8", 2'10", 3'0"	2'8", 2'10", 3'0"	
Glass Sizes			217	617

## MAHOGANY TEXTURED FIBREGLASS





	2 Hollister Oval	2P Arch	6	8	Half Sidelite	Full Sidelite	3/4 Sidelite
6'8"	2'8", 2'10", 3'0"	2'8", 2'10", 3'0"	2'8", 2'10", 3'0"	2'10", 3'0"	1'0", 1'2"	1'0", 1'2"	1'0", 1'2"
8'0"	2'8", 2'10", 3'0"		2'8", 2'10", 3'0", 3'6"		1'0", 1'2"	1'0", 1'2"	1'0", 1'2"
Glass Sizes	122, 304, 306, 404	106, 107	106, 122, 228, 404, 810	203	129, 450	151, 152, 852	151, 450





# Slab Sizing







## OAK TEXTURED FIBREGLASS

			
	Flush	4 Blank Top	6
6'8"	2'0", 2'6", 2'8", 2'10", 3'0", 3'6"	2'8", 2'10", 3'0"	2'6", 2'8", 2'10", 3'0"
8'0"	2'6", 2'8", 2'10", 3'0", 3'6"		2'6", 2'8", 2'10", 3'0"
Glass Sizes	120, 122, 152, 810	106, 107, 135, 137, 228	106, 120, 122, 228, 404, 810

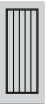





  

			
	1/2 Sidelite	Full Sidelite	3/4 Sidelite
6'8"	1'0", 1'2"	1'0", 1'2"	1'0", 1'2"
8'0"	1'0", 1'2"	1'0", 1'2"	1'0", 1'2"
Glass Sizes	129, 450	151, 152, 852	151, 450







## RUSTIC MAHOAGANY TEXTURED FIBREGLASS

							
	1P Square	1P Arch	2P Arch	2P Square	2 Square	2 Arch	Full Glass Sidelite
6'8"	3'0"		3'0"		3'0"	3'0", 3'6"	1'0"
8'0"	3'0", 3'6"	3'0", 3'6"	3'0", 3'6"	3'0", 3'6"			1'0"
Glass Sizes							152



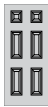



## SMOOTH FIBREGLASS

						
	Flush	1 Shaker	2 Shaker	2 Square	2 Hollister Oval	2P Arch
6'8"	2'0", 2'6", 2'8", 2'10", 3'0", 3'6"	2'8", 2'10", 3'0"	2'8", 2'10", 3'0"	2'8", 2'10", 3'0"	2'8", 2'10", 3'0"	2'8", 2'10", 3'0"
8'0"	2'0", 2'6", 2'8", 2'10", 3'0", 3'6"	2'8", 2'10", 3'0"	2'8", 2'10", 3'0"	2'8", 2'10", 3'0"	2'8", 2'10", 3'0"	2'8", 2'10", 3'0"
Glass Sizes	120, 122, 152, 300, 810			106	122, 304, 306, 404	106, 107, 404







						
	3 Craftsman	4 Blank Top	6	680	680	682
6'8"	2'8", 2'10", 3'0"	2'8", 2'10", 3'0"	2'6", 2'8", 2'10", 3'0"	2'8", 2'10", 3'0"	2'8", 2'10", 3'0"	2'8", 2'10", 3'0"
8'0"	2'8", 2'10", 3'0", 3'6"		2'6", 2'8", 2'10", 3'0"		2'8", 2'10", 3'0"	2'8", 2'10", 3'0"
Glass Sizes	217	106, 107, 135, 137, 228	106, 120, 122, 228, 404, 810	680	680	682







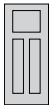

						
	223	223	1/2 Glass Sidelite	Full Glass Sidelite	3/4 Glass Sidelite	Craftsman Sidelite
6'8"	2'8", 2'10", 3'0"		1'0", 1'2"	1'0", 1'2"	1'0", 1'2"	1'0", 1'2"
8'0"		2'8", 2'10", 3'0"	1'0", 1'2"	1'0", 1'2"	1'0", 1'2"	1'0", 1'2"
Glass Sizes	223	223	129, 450	151, 152, 852	151, 450	615

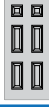
# Slab Sizing







## STEEL

								
	Flush	2 Square	2 Arch	2P Arch	2 Hollister	3 Craftsman	3 Equal	3 Arch
6'8"	2'0", 2'6", 2'8", 2'10", 3'0"	2'8", 2'10", 3'0"	2'8", 2'10", 3'0"	2'8", 2'10", 3'0"	2'8", 2'10", 3'0"	2'8", 2'10", 3'0"	2'8", 2'10", 3'0"	2'8", 2'10", 3'0"
8'0"	2'6", 2'8", 2'10", 3'0"							
Glass Sizes	120, 122, 152, 300, 810	106	106, 107	106, 107	404	217	217	304, 404



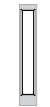

								
	6	8	680	680	223	223	682	Linea
6'8"	2'6", 2'8", 2'10", 3'0"	2'8", 2'10", 3'0"	2'8", 2'10", 3'0"		2'8", 2'10", 3'0"		2'8", 2'10", 3'0"	2'8", 2'10", 3'0"
8'0"	2'8", 2'10", 3'0"			2'8", 2'10", 3'0"		2'8", 2'10", 3'0"	2'8", 2'10", 3'0"	
Glass Sizes	106, 120, 122, 404, 810	203	680	680	223	223	682	152



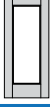

							
	OSO	SOHO	VOG	1/2 Glass Sidelite	Full Glass Sidelite	3/4 Glass Sidelite	Craftsman Sidelite
6'8"	2'10", 3'0"	2'8", 2'10", 3'0"	2'10", 3'0"	1'0", 1'2"	1'0", 1'2"	1'0", 1'2"	1'0", 1'2"
8'0"		2'8", 2'10", 3'0"	2'10", 3'0"	1'0", 1'2"	1'0", 1'2"	1'0", 1'2"	
Glass Sizes	152			129, 450	151, 152, 852	151, 450	615

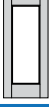
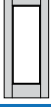
## VISTAGRANDE® SMOOTH & FIR TEXTURED FIBREGLASS

				
	Full Glass	Full Glass	Full Glass	Full Glass
6'8"	2'6"	2'8"	2'10"	3'0"
8'0"	2'6"	2'8"	2'10"	3'0"
Glass Sizes	120, 820	122, 810	122, 810	926, 826

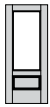
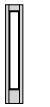
			
	3/4 Glass	Full Glass Sidelite	3/4 Glass Sidelite
6'8"	3'0"	1'0", 1'2"	1'0", 1'2"
8'0"	3'0"	1'0", 1'2"	1'0", 1'2"
Glass Sizes	426, 926	152, 852	450, 151

# Frame & Rough Opening Sizes

## SINGLE DOORS

NOMINAL DOOR SIZE		OVERALL DOOR UNIT SIZE (OSM)			ROUGH OPENING (RO)			2" RENO BRICKMOULD (OSBM)			2" WOOD BRICKMOULD (OSBM)		
Width	Height	Width	Height		Width	Height		Width	Height		Width	Height	
			Inswing	Outswing		Inswing	Outswing		Inswing	Outswing		Inswing	Outswing
2'0"	6'8"	25-9/16"	81-5/8"	81-3/8"	26-9/16"	82-1/8"	81-7/8"	28-1/2"	83-1/8"	82-7/8"	28"	82-7/8"	82-5/8"
2'0"	8'0"	25-9/16"	97-5/8"	97-3/8"	26-9/16"	98-1/8"	97-7/8"	28-1/2"	99-1/8"	98-7/8"	28"	98-7/8"	98-5/8"
2'6"	6'8"	31-9/16"	81-5/8"	81-3/8"	32-9/16"	82-1/8"	81-7/8"	34-1/2"	83-1/8"	82-7/8"	34"	82-7/8"	82-5/8"
2'6"	8'0"	31-9/16"	97-5/8"	97-3/8"	32-9/16"	98-1/8"	97-7/8"	34-1/2"	99-1/8"	98-7/8"	34"	98-7/8"	98-5/8"
2'8"	6'8"	33-9/16"	81-5/8"	81-3/8"	34-9/16"	82-1/8"	81-7/8"	36-1/2"	83-1/8"	82-7/8"	36"	82-7/8"	82-5/8"
2'8"	8'0"	33-9/16"	97-5/8"	97-3/8"	34-9/16"	98-1/8"	97-7/8"	36-1/2"	99-1/8"	98-7/8"	36"	98-7/8"	98-5/8"
2'10"	6'8"	35-9/16"	81-5/8"	81-3/8"	36-9/16"	82-1/8"	81-7/8"	38-1/2"	83-1/8"	82-7/8"	38"	82-7/8"	82-5/8"
2'10"	8'0"	35-9/16"	97-5/8"	97-3/8"	36-9/16"	98-1/8"	97-7/8"	38-1/2"	99-1/8"	98-7/8"	38"	98-7/8"	98-5/8"
3'0"	6'8"	37-9/16"	81-5/8"	81-3/8"	38-9/16"	82-1/8"	81-7/8"	40-1/2"	83-1/8"	82-7/8"	40"	82-7/8"	82-5/8"
3'0"	8'0"	37-9/16"	97-5/8"	97-3/8"	38-9/16"	98-1/8"	97-7/8"	40-1/2"	99-1/8"	98-7/8"	40"	98-7/8"	98-5/8"
3'6"	6'8"	43-9/16"	81-5/8"	81-3/8"	44-9/16"	82-1/8"	81-7/8"	46-1/2"	83-1/8"	82-7/8"	46"	82-7/8"	82-5/8"
3'6"	8'0"	43-9/16"	97-5/8"	97-3/8"	44-9/16"	98-1/8"	97-7/8"	46-1/2"	99-1/8"	98-7/8"	46"	98-7/8"	98-5/8"

## DOUBLE DOORS

NOMINAL DOOR SIZE		OVERALL DOOR UNIT SIZE (OSM)			ROUGH OPENING (RO)			2" RENO BRICKMOULD (OSBM)			2" WOOD BRICKMOULD (OSBM)		
Width	Height	Width	Height		Width	Height		Width	Height		Width	Height	
			Inswing	Outswing		Inswing	Outswing		Inswing	Outswing		Inswing	Outswing
2'0"	6'8"	50-3/8"	81-5/8"	81-3/8"	51-3/8"	82-1/8"	81-7/8"	53-5/16"	83-1/8"	82-7/8"	52-7/8"	82-7/8"	82-5/8"
2'0"	8'0"	50-3/8"	97-5/8"	97-3/8"	51-3/8"	98-1/8"	97-7/8"	53-5/16"	99-1/8"	98-7/8"	52-7/8"	98-7/8"	98-5/8"
2'6"	6'8"	62-3/8"	81-5/8"	81-3/8"	63-3/8"	82-1/8"	81-7/8"	65-5/16"	83-1/8"	82-7/8"	64-7/8"	82-7/8"	82-5/8"
2'6"	8'0"	62-3/8"	97-5/8"	97-3/8"	63-3/8"	98-1/8"	97-7/8"	65-5/16"	99-1/8"	98-7/8"	64-7/8"	98-7/8"	98-5/8"
2'8"	6'8"	66-3/8"	81-5/8"	81-3/8"	67-3/8"	82-1/8"	81-7/8"	69-5/16"	83-1/8"	82-7/8"	68-7/8"	82-7/8"	82-5/8"
2'8"	8'0"	66-3/8"	97-5/8"	97-3/8"	67-3/8"	98-1/8"	97-7/8"	69-5/16"	99-1/8"	98-7/8"	68-7/8"	98-7/8"	98-5/8"
2'10"	6'8"	70-3/8"	81-5/8"	81-3/8"	71-3/8"	82-1/8"	81-7/8"	73-5/16"	83-1/8"	82-7/8"	72-7/8"	82-7/8"	82-5/8"
2'10"	8'0"	70-3/8"	97-5/8"	97-3/8"	71-3/8"	98-1/8"	97-7/8"	73-5/16"	99-1/8"	98-7/8"	72-7/8"	98-7/8"	98-5/8"
3'0"	6'8"	74-3/8"	81-5/8"	81-3/8"	75-3/8"	82-1/8"	81-7/8"	77-5/16"	83-1/8"	82-7/8"	76-7/8"	82-7/8"	82-5/8"
3'0"	8'0"	74-3/8"	97-5/8"	97-3/8"	75-3/8"	98-1/8"	97-7/8"	77-5/16"	99-1/8"	98-7/8"	76-7/8"	98-7/8"	98-5/8"
3'6"	6'8"	86-3/8"	81-5/8"	81-3/8"	87-3/8"	82-1/8"	81-7/8"	89-5/16"	83-1/8"	82-7/8"	88-7/8"	82-7/8"	82-5/8"
3'6"	8'0"	86-3/8"	97-5/8"	97-3/8"	87-3/8"	98-1/8"	97-7/8"	89-5/16"	99-1/8"	98-7/8"	88-7/8"	98-7/8"	98-5/8"

## GARDEN & RENOVATION GARDEN DOORS

NOMINAL DOOR SIZE		OVERALL DOOR UNIT SIZE (OSM)			ROUGH OPENING (RO)			2" RENO BRICKMOULD (OSBM)			2" WOOD BRICKMOULD (OSBM)		
Width	Height	Width	Height		Width	Height		Width	Height		Width	Height	
			Inswing	Outswing		Inswing	Outswing		Inswing	Outswing		Inswing	Outswing
2'4"	6'7"	59-3/8"	-	79-3/8"	60-3/8"	-	79-7/8"	62-5/16"	-	80-7/8"	61-13/16"	-	80-5/8"
2'6"	6'8"	63-3/8"	81-5/8"	81-3/8"	64-3/8"	82-1/8"	81-7/8"	66-5/16"	83-1/8"	82-7/8"	65-7/8"	82-7/8"	82-5/8"
2'6"	8'0"	63-3/8"	97-5/8"	81-3/8"	64-3/8"	98-1/8"	97-7/8"	66-5/16"	99-1/8"	98-7/8"	65-7/8"	98-7/8"	98-5/8"
2'8"	6'8"	67-3/8"	81-5/8"	81-3/8"	68-3/8"	82-1/8"	81-7/8"	70-5/16"	83-1/8"	82-7/8"	69-7/8"	82-7/8"	82-5/8"
2'8"	8'0"	67-3/8"	97-5/8"	97-3/8"	68-3/8"	98-1/8"	97-7/8"	70-5/16"	99-1/8"	98-7/8"	69-7/8"	98-7/8"	98-5/8"
2'10"	6'7"	71-3/8"	-	79-3/8"	72-3/8"	-	79-7/8"	74-5/16"	-	80-7/8"	73-13/16"	-	80-5/8"
2'10"	6'8"	71-3/8"	81-5/8"	81-3/8"	72-3/8"	82-1/8"	81-7/8"	74-5/16"	83-1/8"	82-7/8"	73-7/8"	82-7/8"	82-5/8"
2'10"	8'0"	71-3/8"	97-5/8"	97-3/8"	72-3/8"	98-1/8"	97-7/8"	74-5/16"	99-1/8"	98-7/8"	73-7/8"	98-7/8"	98-5/8"
3'0"	6'8"	75-3/8"	81-5/8"	81-3/8"	76-3/8"	82-1/8"	81-7/8"	78-5/16"	83-1/8"	82-7/8"	77-7/8"	82-7/8"	82-5/8"
3'0"	8'0"	75-3/8"	97-5/8"	97-3/8"	76-3/8"	98-1/8"	97-7/8"	78-5/16"	99-1/8"	98-7/8"	77-7/8"	98-7/8"	98-5/8"

Note: All dimensions shown on this page are for planning/estimation purposes only. Rough opening sizes shown are recommendations only and actual rough openings in your home may vary. Depending on the configuration and product selection, rough opening dimensions may be different. Floor coverings can affect rough opening heights. Always verify final door unit dimensions on your All Weather at Home quote.

### SINGLE DOORS WITH ONE SIDELITE

NOMINAL DOOR SIZE		SIDELITE SIZE		OVERALL DOOR UNIT SIZE (OSM)			ROUGH OPENING (RO)			2" RENO BRICKMOULD (OSBM)			2" WOOD BRICKMOULD (OSBM)		
Width	Height	Width	Height	Width	Height		Width	Height		Width	Height		Width	Height	
					Inswing	Outswing		Inswing	Outswing		Inswing	Outswing		Inswing	Outswing
2'0"	6'8"	1'0"	6'8"	39-1/2"	81-5/8"	81-3/8"	40-1/2"	82-1/8"	81-7/8"	42-7/16"	83-1/8"	82-7/8"	42"	82-7/8"	82-5/8"
2'0"	6'8"	1'2"	6'8"	41-1/2"	81-5/8"	81-3/8"	42-1/2"	82-1/8"	81-7/8"	44-7/16"	83-1/8"	82-7/8"	44"	82-7/8"	82-5/8"
2'0"	8'0"	1'0"	8'0"	39-1/2"	97-5/8"	97-3/8"	40-1/2"	98-1/8"	97-7/8"	42-7/16"	99-1/8"	98-7/8"	42"	98-7/8"	98-5/8"
2'0"	8'0"	1'2"	8'0"	41-1/2"	97-5/8"	97-3/8"	42-1/2"	98-1/8"	97-7/8"	44-7/16"	99-1/8"	98-7/8"	44"	98-7/8"	98-5/8"
2'6"	6'8"	1'0"	6'8"	45-1/2"	81-5/8"	81-3/8"	46-1/2"	82-1/8"	81-7/8"	48-7/16"	83-1/8"	82-7/8"	48"	82-7/8"	82-5/8"
2'6"	6'8"	1'2"	6'8"	47-1/2"	81-5/8"	81-3/8"	48-1/2"	82-1/8"	81-7/8"	50-7/16"	83-1/8"	82-7/8"	50"	82-7/8"	82-5/8"
2'6"	8'0"	1'0"	8'0"	45-1/2"	97-5/8"	97-3/8"	46-1/2"	98-1/8"	97-7/8"	48-7/16"	99-1/8"	98-7/8"	48"	98-7/8"	98-5/8"
2'6"	8'0"	1'2"	8'0"	47-1/2"	97-5/8"	97-3/8"	48-1/2"	98-1/8"	97-7/8"	50-7/16"	99-1/8"	98-7/8"	50"	98-7/8"	98-5/8"
2'8"	6'8"	1'0"	6'8"	47-1/2"	81-5/8"	81-3/8"	48-1/2"	82-1/8"	81-7/8"	50-7/16"	83-1/8"	82-7/8"	50"	82-7/8"	82-5/8"
2'8"	6'8"	1'2"	6'8"	49-1/2"	81-5/8"	81-3/8"	50-1/2"	82-1/8"	81-7/8"	52-7/16"	83-1/8"	82-7/8"	52"	82-7/8"	82-5/8"
2'8"	8'0"	1'0"	8'0"	47-1/2"	97-5/8"	97-3/8"	48-1/2"	98-1/8"	97-7/8"	50-7/16"	99-1/8"	98-7/8"	50"	98-7/8"	98-5/8"
2'8"	8'0"	1'2"	8'0"	49-1/2"	97-5/8"	97-3/8"	50-1/2"	98-1/8"	97-7/8"	52-7/16"	99-1/8"	98-7/8"	52"	98-7/8"	98-5/8"
2'10"	6'8"	1'0"	6'8"	49-1/2"	81-5/8"	81-3/8"	50-1/2"	82-1/8"	81-7/8"	52-7/16"	83-1/8"	82-7/8"	52"	82-7/8"	82-5/8"
2'10"	6'8"	1'2"	6'8"	51-1/2"	81-5/8"	81-3/8"	52-1/2"	82-1/8"	81-7/8"	54-7/16"	83-1/8"	82-7/8"	54"	82-7/8"	82-5/8"
2'10"	8'0"	1'0"	8'0"	49-1/2"	97-5/8"	97-3/8"	50-1/2"	98-1/8"	97-7/8"	52-7/16"	99-1/8"	98-7/8"	52"	98-7/8"	98-5/8"
2'10"	8'0"	1'2"	8'0"	51-1/2"	97-5/8"	97-3/8"	52-1/2"	98-1/8"	97-7/8"	54-7/16"	99-1/8"	98-7/8"	54"	98-7/8"	98-5/8"
3'0"	6'8"	1'0"	6'8"	51-1/2"	81-5/8"	81-3/8"	52-1/2"	82-1/8"	81-7/8"	54-7/16"	83-1/8"	82-7/8"	54"	82-7/8"	82-5/8"
3'0"	6'8"	1'2"	6'8"	53-1/2"	81-5/8"	81-3/8"	54-1/2"	82-1/8"	81-7/8"	56-7/16"	83-1/8"	82-7/8"	56"	82-7/8"	82-5/8"
3'0"	8'0"	1'0"	8'0"	51-1/2"	97-5/8"	97-3/8"	52-1/2"	98-1/8"	97-7/8"	54-7/16"	99-1/8"	98-7/8"	54"	98-7/8"	98-5/8"
3'0"	8'0"	1'2"	8'0"	53-1/2"	97-5/8"	97-3/8"	54-1/2"	98-1/8"	97-7/8"	56-7/16"	99-1/8"	98-7/8"	54"	98-7/8"	98-5/8"
3'6"	6'8"	1'0"	6'8"	57-1/2"	81-5/8"	81-3/8"	58-1/2"	82-1/8"	81-7/8"	60-7/16"	83-1/8"	82-7/8"	60"	82-7/8"	82-5/8"
3'6"	6'8"	1'2"	6'8"	59-1/2"	81-5/8"	81-3/8"	60-1/2"	82-1/8"	81-7/8"	62-7/16"	83-1/8"	82-7/8"	62"	82-7/8"	82-5/8"
3'6"	8'0"	1'0"	8'0"	57-1/2"	97-5/8"	97-3/8"	58-1/2"	98-1/8"	97-7/8"	60-7/16"	99-1/8"	98-7/8"	60"	98-7/8"	98-5/8"
3'6"	8'0"	1'2"	8'0"	59-1/2"	97-5/8"	97-3/8"	60-1/2"	98-1/8"	97-7/8"	62-7/16"	99-1/8"	98-7/8"	62"	98-7/8"	98-5/8"

### SINGLE DOORS WITH TWO SIDELITES

NOMINAL DOOR SIZE		SIDELITE SIZE		OVERALL DOOR UNIT SIZE (OSM)			ROUGH OPENING (RO)			2" RENO BRICKMOULD (OSBM)			2" WOOD BRICKMOULD (OSBM)		
Width	Height	Width	Height	Width	Height		Width	Height		Width	Height		Width	Height	
					Inswing	Outswing		Inswing	Outswing		Inswing	Outswing		Inswing	Outswing
2'0"	6'8"	1'0"	6'8"	53-7/16"	81-5/8"	81-3/8"	54-7/16"	82-1/8"	81-7/8"	56-3/8"	83-1/8"	82-7/8"	55-7/8"	82-7/8"	82-5/8"
2'0"	6'8"	1'2"	6'8"	57-7/16"	81-5/8"	81-3/8"	58-7/16"	82-1/8"	81-7/8"	60-3/8"	83-1/8"	82-7/8"	59-7/8"	82-7/8"	82-5/8"
2'0"	8'0"	1'0"	8'0"	53-7/16"	97-5/8"	97-3/8"	54-7/16"	98-1/8"	97-7/8"	56-3/8"	99-1/8"	98-7/8"	55-7/8"	98-7/8"	98-5/8"
2'0"	8'0"	1'2"	8'0"	57-7/16"	97-5/8"	97-3/8"	58-7/16"	98-1/8"	97-7/8"	60-3/8"	99-1/8"	98-7/8"	59-7/8"	98-7/8"	98-5/8"
2'6"	6'8"	1'0"	6'8"	59-7/16"	81-5/8"	81-3/8"	60-7/16"	82-1/8"	81-7/8"	62-3/8"	83-1/8"	82-7/8"	61-7/8"	82-7/8"	82-5/8"
2'6"	6'8"	1'2"	6'8"	63-7/16"	81-5/8"	81-3/8"	64-7/16"	82-1/8"	81-7/8"	66-3/8"	83-1/8"	82-7/8"	65-7/8"	82-7/8"	82-5/8"
2'6"	8'0"	1'0"	8'0"	59-7/16"	97-5/8"	97-3/8"	60-7/16"	98-1/8"	97-7/8"	62-3/8"	99-1/8"	98-7/8"	61-7/8"	98-7/8"	98-5/8"
2'6"	8'0"	1'2"	8'0"	63-7/16"	97-5/8"	97-3/8"	64-7/16"	98-1/8"	97-7/8"	66-3/8"	99-1/8"	98-7/8"	65-7/8"	98-7/8"	98-5/8"
2'8"	6'8"	1'0"	6'8"	61-7/16"	81-5/8"	81-3/8"	62-7/16"	82-1/8"	81-7/8"	64-3/8"	83-1/8"	82-7/8"	63-7/8"	82-7/8"	82-5/8"
2'8"	6'8"	1'2"	6'8"	65-7/16"	81-5/8"	81-3/8"	66-7/16"	82-1/8"	81-7/8"	68-3/8"	83-1/8"	82-7/8"	67-7/8"	82-7/8"	82-5/8"
2'8"	8'0"	1'0"	8'0"	61-7/16"	97-5/8"	97-3/8"	62-7/16"	98-1/8"	97-7/8"	64-3/8"	99-1/8"	98-7/8"	63-7/8"	98-7/8"	98-5/8"
2'8"	8'0"	1'2"	8'0"	65-7/16"	97-5/8"	97-3/8"	66-7/16"	98-1/8"	97-7/8"	68-3/8"	99-1/8"	98-7/8"	67-7/8"	98-7/8"	98-5/8"
2'10"	6'8"	1'0"	6'8"	63-7/16"	81-5/8"	81-3/8"	64-7/16"	82-1/8"	81-7/8"	66-3/8"	83-1/8"	82-7/8"	65-7/8"	82-7/8"	82-5/8"
2'10"	6'8"	1'2"	6'8"	67-7/16"	81-5/8"	81-3/8"	68-7/16"	82-1/8"	81-7/8"	70-3/8"	83-1/8"	82-7/8"	69-7/8"	82-7/8"	82-5/8"
2'10"	8'0"	1'0"	8'0"	63-7/16"	97-5/8"	97-3/8"	64-7/16"	98-1/8"	97-7/8"	66-3/8"	99-1/8"	98-7/8"	65-7/8"	98-7/8"	98-5/8"
2'10"	8'0"	1'2"	8'0"	67-7/16"	97-5/8"	97-3/8"	68-7/16"	98-1/8"	97-7/8"	70-3/8"	99-1/8"	98-7/8"	69-7/8"	98-7/8"	98-5/8"
3'0"	6'8"	1'0"	6'8"	65-7/16"	81-5/8"	81-3/8"	66-7/16"	82-1/8"	81-7/8"	68-3/8"	83-1/8"	82-7/8"	67-7/8"	82-7/8"	82-5/8"
3'0"	6'8"	1'2"	6'8"	69-7/16"	81-5/8"	81-3/8"	70-7/16"	82-1/8"	81-7/8"	72-3/8"	83-1/8"	82-7/8"	71-7/8"	82-7/8"	82-5/8"
3'0"	8'0"	1'0"	8'0"	65-7/16"	97-5/8"	97-3/8"	66-7/16"	98-1/8"	97-7/8"	68-3/8"	99-1/8"	98-7/8"	67-7/8"	98-7/8"	98-5/8"
3'0"	8'0"	1'2"	8'0"	69-7/16"	97-5/8"	97-3/8"	70-7/16"	98-1/8"	97-7/8"	72-3/8"	99-1/8"	98-7/8"	71-7/8"	98-7/8"	98-5/8"
3'6"	6'8"	1'0"	6'8"	71-7/16"	81-5/8"	81-3/8"	72-7/16"	82-1/8"	81-7/8"	74-3/8"	83-1/8"	82-7/8"	73-7/8"	82-7/8"	82-5/8"
3'6"	6'8"	1'2"	6'8"	75-7/16"	81-5/8"	81-3/8"	76-7/16"	82-1/8"	81-7/8"	78-3/8"	83-1/8"	82-7/8"	77-7/8"	82-7/8"	82-5/8"
3'6"	8'0"	1'0"	8'0"	71-7/16"	97-5/8"	97-3/8"	72-7/16"	98-1/8"	97-7/8"	74-3/8"	99-1/8"	98-7/8"	73-7/8"	98-7/8"	98-5/8"
3'6"	8'0"	1'2"	8'0"	75-7/16"	97-5/8"	97-3/8"	76-7/16"	98-1/8"	97-7/8"	78-3/8"	99-1/8"	98-7/8"	77-7/8"	98-7/8"	98-5/8"

Note: All dimensions shown on this page are for planning/estimation purposes only. Rough opening sizes shown are recommendations only and actual rough openings in your home may vary. Depending on the configuration and product selection, rough opening dimensions may be different. Floor coverings can affect rough opening heights. Always verify final door unit dimensions on your All Weather at Home quote.



# Measuring Your Door

## STEP 1

### MEASURE YOUR DOOR SLAB WIDTH

This is the measurement from the left edge of your door slab, straight across to the right edge (**A**).

## STEP 2

### MEASURE YOUR DOOR SLAB HEIGHT

This is the measurement from the top edge of your door slab, straight down to the very bottom, excluding the door sweep (**B**).

## STEP 3

### DETERMINE YOUR DOOR FRAME JAMB DEPTH

Your door jamb is the overall depth of your door frame which transitions from the exterior of your home to the interior, meeting up with your casing. This measurement usually includes the exterior sheathing, stud and drywall thicknesses. This measurement is not always easy to determine, so don't worry if you cannot get an exact measurement. A qualified installer can help.

## STEP 4

### DETERMINE YOUR DOOR'S HANDING AND SWING

Using the diagrams below, determine and select the swing and handing of your existing door. Remember, always view and determine your door handing and swing from the **EXTERIOR** of your home.

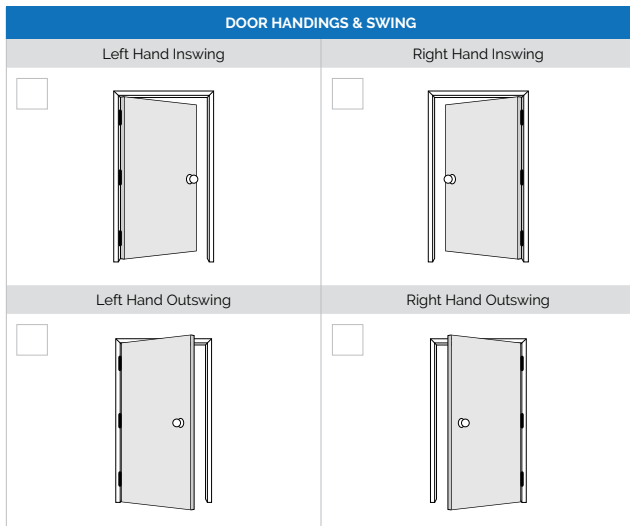

## STEP 5

### FINAL CALCULATIONS

After determining your existing door slab measurements from steps 1 & 2, record them in the first row below. Next, add the necessary measurement shown to determine the overall outside measurement (OSM) of your door frame.

WIDTH	HEIGHT	DEPTH
Slab width from Step 1:	Slab height from Step 2:	Jamb depth from Step 3:
<input type="text"/> ↓ <b>ADD 1-3/4"</b> ↓	<input type="text"/> ↓ <b>ADD 2-1/8"</b> for inswing doors or <b>2"</b> for outswing doors ↓	<input type="text"/> ↓
<b>Overall door OSM width:</b>	<b>Overall door OSM height:</b>	<b>Overall door jamb depth:</b>
<input type="text"/>	<input type="text"/>	<input type="text"/>

**Note:** There is no industry standard for door sizing, so follow these steps carefully to ensure you determine the optimal fit for your new door. It is strongly recommended to have a professional installer measure and install your door. Reach out to an All Weather at Home representative or authorized dealer for assistance.

# Door Planner

## Let's help you make it happen

Now that you're inspired and have the confidence to create a door that perfectly compliments your style and personality, use the section below to sketch out and plan each of your doors. Once complete, simply bring in this page to an All Weather at Home sales representative or authorized dealer.

### ENTRY DOOR 1

Location: \_\_\_\_\_

▼ SKETCH YOUR DOOR HERE ▼

Slab Material: \_\_\_\_\_ Door Size: \_\_\_\_\_

Glass Style: \_\_\_\_\_

Frame Colour: \_\_\_\_\_

Slab Colour: \_\_\_\_\_

Hardware Finish: \_\_\_\_\_

### ENTRY DOOR 2

Location: \_\_\_\_\_

▼ SKETCH YOUR DOOR HERE ▼

Slab Material: \_\_\_\_\_ Door Size: \_\_\_\_\_

Glass Style: \_\_\_\_\_

Frame Colour: \_\_\_\_\_

Slab Colour: \_\_\_\_\_

Hardware Finish: \_\_\_\_\_

### ENTRY DOOR 3

Location: \_\_\_\_\_

▼ SKETCH YOUR DOOR HERE ▼

Slab Material: \_\_\_\_\_ Door Size: \_\_\_\_\_

Glass Style: \_\_\_\_\_

Frame Colour: \_\_\_\_\_

Slab Colour: \_\_\_\_\_

Hardware Finish: \_\_\_\_\_

### GARDEN/DOUBLE DOOR

Location: \_\_\_\_\_

▼ SKETCH YOUR DOOR HERE ▼

Slab Material: \_\_\_\_\_ Door Size: \_\_\_\_\_

Glass Style: \_\_\_\_\_

Frame Colour: \_\_\_\_\_

Slab Colour: \_\_\_\_\_

Hardware Finish: \_\_\_\_\_







# Door Glass Size Code & Panel Legend

## Door Panel Codes

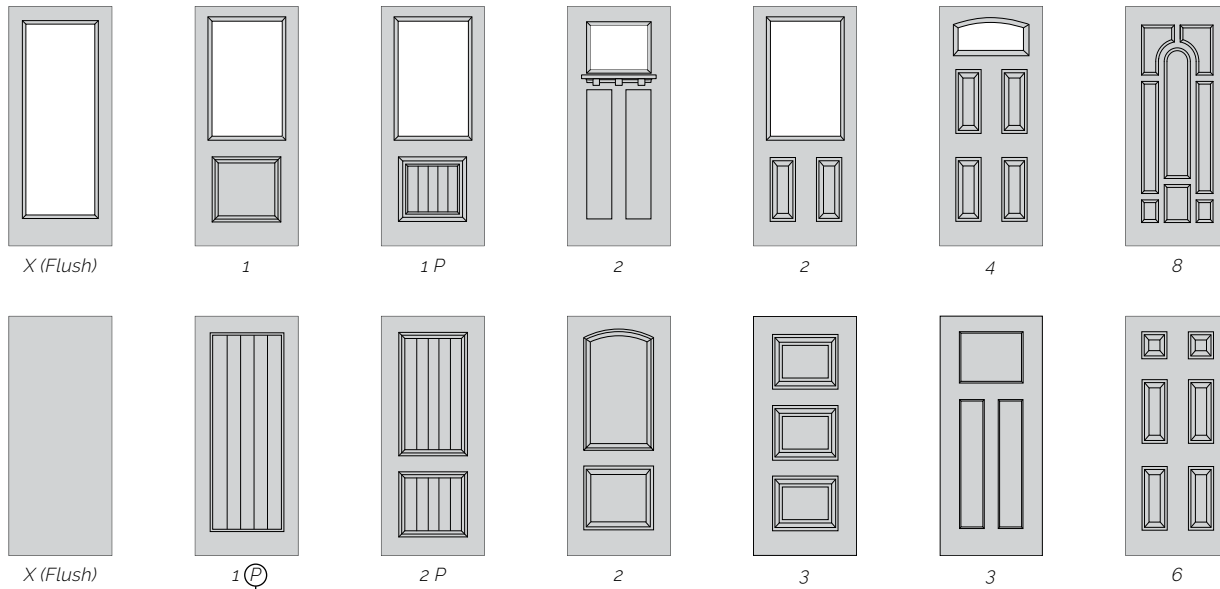

a "P" indicates that the door panel(s) have planked embossing

## Door Glass Size Codes

<b>104</b> 29" x 37" . . . . . Rectangle	<b>155</b> 6" x 64" . . . . . Rectangle	<b>404</b> 22" x 48" . . . . . Rectangle
<b>106</b> 22" x 36" . . . . . Rectangle	<b>160</b> 20" x 36" . . . . . Rectangle	<b>405</b> 22" x 48" . . . . . Rectangle
<b>107</b> 22" x 37.5" . . . Arch Top	<b>201</b> 8" x 58" . . . . . Round Top	<b>411</b> 22" x 37.5" . . . Arch Top
<b>108</b> 20" x 20" . . . . . Square	<b>203</b> 8" x 42" . . . . . Round Top	<b>420</b> 20" x 48" . . . . . Rectangle
<b>114</b> 14" x 64" . . . . . Rectangle	<b>212</b> 22" x 8" . . . . . Rectangle	<b>426</b> 26" x 48" . . . . . Rectangle
<b>120</b> 20" x 64" . . . . . Rectangle	<b>215</b> 22" x 16" . . . . . Rectangle	<b>450</b> 8" x 48" . . . . . Rectangle
<b>122</b> 22" x 64" . . . . . Rectangle	<b>217</b> 22" x 17" . . . . . Rectangle	<b>451</b> 8" x 48" . . . . . Rectangle
<b>126</b> 26" x 36" . . . . . Rectangle	<b>222</b> 22" x 12" . . . . . Rectangle	<b>610</b> 9" x 17" . . . . . Rectangle
<b>129</b> 8" x 36" . . . . . Rectangle	<b>223</b> 22" x 3.5" . . . . . Rectangle	<b>615</b> 8" x 16" . . . . . Rectangle
<b>133</b> 22" x 9" . . . . . Rectangle	<b>225</b> 22" x 15" . . . . . Rectangle	<b>617</b> 8" x 17" . . . . . Rectangle
<b>135</b> 22" x 10" . . . . . Sunburst	<b>226</b> 22" x 17" . . . . . Rectangle	<b>680</b> 8" x 6" . . . . . Rectangle
<b>136</b> 7.5" x 18.5" . . . Rectangle	<b>228</b> 22" x 10" . . . . . Rectangle	<b>682</b> 8" x 8" . . . . . Square
<b>137</b> 22" x 10" . . . . . Arch Top	<b>251</b> 22" x 10" . . . . . Arch Top	<b>806</b> 8" x 6" . . . . . Rectangle
<b>151</b> 8" x 64" . . . . . Rectangle	<b>300</b> 20" x 57" . . . . . Oval	<b>808</b> 8" x 8" . . . . . Square
<b>152</b> 7" x 64" . . . . . Rectangle	<b>302</b> 14" x 52" . . . . . Oval	<b>810</b> 22" x 80" . . . . . Rectangle
<b>153</b> 6.5" x 61.25" . . . Rectangle	<b>303</b> 16" x 40" . . . . . Oval	<b>814</b> 14" x 80" . . . . . Rectangle
<b>154</b> 7" x 64" . . . . . Rectangle	<b>304</b> 16" x 40" . . . . . Oval	<b>820</b> 20" x 80" . . . . . Rectangle
		<b>826</b> 26" x 80" . . . . . Rectangle
		<b>852</b> 8" x 80" . . . . . Rectangle
		<b>853</b> 8" x 80" . . . . . Rectangle
		<b>926</b> 26" x 64" . . . . . Rectangle



Rectangle



Arch Top



Oval



Round Top



Sunburst

## A

Adelaide ADE (T) 48, 106  
 Alys (N) 49, 106  
 Arima (N) 46, 50, 106  
 Astragal 96  
 Azur 338 (N) 51, 106

## B

Barrington Sierra (M) 27, 30, 121  
 Blinds (Internal) 37, 90, 116, 120  
 Bolero (N) 43, 52, 106  
 Brickmould 104

## C

Cachet (N) 47, 53, 106  
 Celeste 367 (N) 17, 54, 106  
 Chanelle 308 (N) 43, 55, 106  
 Chelsea® 341 (M) 56, 108  
 Cherry Woodgrain 32  
 Chord® 115 (M) 37, 44, 57, 108, 120  
 Cladding 105  
 Clear Glass 74, 88, 114, 120  
 Colour 105  
 Contemporary Cherry (T) 13, 27, 32, 121  
 Craftsman Smooth (T) 4, 36, 119, 121  
 Cross Reed 74, 118  
 Crosswalk (O) 58, 108  
 Cruz™ 341 (M) 59, 108  
 Cuzco® 364 (M) 40, 60, 108

## D

Decorative Glass 46  
 Dentil Shelf 41, 43  
 Designer Fibreglass 30, 32, 34  
 Door Planner 127  
 Double Doors 96

## E

Element® 328 (M) 41, 61, 108  
 ENERGY STAR® 100  
 Entropy (O) 62, 108  
 Entry Door System 101  
 Equation (N) 63, 108

## F

Fast-Frame® 98  
 Finishes 105  
 Fir Woodgrain 37, 41, 121  
 Fire Rated Door System 98  
 Fluid 079 (N) 12, 64, 110  
 Flush 24  
 Flush-Glazed 28, 39  
 Focus® 312 (M) 41, 65, 110  
 Frontier® 312 (M) 43, 66, 110

## G

Garden Doors 96  
 Geo Collection 18, 45  
 Georgian™ 517 (M) 67, 110  
 Grilles 103  
 Grooved Lines 33

## H

Handings 97  
 Hardware 102, 104  
 Harlow (T) 68, 110  
 Hinges 104  
 Hollister HOL (T) 69, 110  
 Hydroshield 39

## I

Inswing 101  
 Internal Blinds (O) 37, 90, 116, 120  
 Internal Grille 103

## J

## K

Kordella® 686 (M) 41, 70, 110

## L

Lexington LEX (T) 71, 110  
 Linea (N) 18, 21, 45, 119, 123  
 Louisbourg (N) 72, 112

## M

Mahogany Woodgrain 31, 34, 41, 121  
 Marco® 331 (M) 73, 112  
 Measuring Your Door 126  
 Metal Cladding 105  
 Mid-Centry Modern (T) 22, 45, 74, 118  
 Mistral (N) 75, 112  
 Modena MOD (T) 76, 112  
 Monterey (O) 77, 112  
 Multilock Hardware 102

## N

NAFS 100  
 Naples® 366 (M) 6, 78, 112  
 Narrow Reed 74, 118  
 New & Trending Doors 8  
 Nuando (N) 79, 112

## O

Oak Woodgrain 41, 122  
 Obscure Glass 88  
 Opal 349 (N) 16, 47, 80, 112  
 Opaque Glass 88  
 Operating Styles 96  
 OSO (T) 18, 19, 45, 119, 123  
 Outswing 101

## P

Panama® 725 (M) 81, 114  
 Panels 119  
 Pear 116 (M) 37, 82, 114, 120  
 Pearl® 140 (M) 37, 83, 114, 120  
 Pre-Painted / Pre-Stained 12, 105  
 Pure 334 (N) 84, 114

## Q

## R

Rain 88  
 Rough Openings 124  
 Royston (T) 85, 114  
 Rozet® 467 (M) 86, 114  
 Rustic Mahogany (T) 28, 34, 122

## S

Sable (T) 74, 118  
 Sand Blasted (T) 74, 118  
 SDL 37, 39, 103, 118, 120  
 Sea Spray (T) 22, 74, 118  
 Shaker Doors 9, 10, 119, 121, 122  
 Sidelites 96  
 Sierra 27, 30, 121  
 Sizing 121  
 Slab Sizing 121  
 Smooth Fibreglass 29, 37, 42, 122  
 Soft 079 (N) 14, 87, 114  
 SOHO (T) 18, 20, 45, 119, 123  
 Stainless Steel Bars 33  
 Steel 29, 44, 123  
 Steel Adjustable Fast-Frame® 98  
 Striker Plates 104  
 Swings 97

## T

Textured Fibreglass 29, 40  
 Textured Glass 88, 114  
 Transit 263 (N) 89, 116  
 Transoms 96

## U

## V

Venting Glass (O) 90, 116  
 Verso (N) 47, 91, 116  
 VistaGrande® (M) 4, 28, 36, 120, 123  
 VOG (T) 18, 45, 119, 123

## W

Winchester (N) 92, 116

## X

## Y

## Z

Zenith 347 (N) 15, 93, 116



# Let's connect

f @ X in

[allweatherathome.ca](http://allweatherathome.ca)

**Toll-Free** (800) 638-5709

**Calgary** (888) 932-3387

**Edmonton** (800) 232-9407

**Lethbridge** (877) 327-0701

**Red Deer** (855) 348-0701

**Regina** (888) 672-2202

**Saskatoon** (800) 589-9899

**Vancouver** (800) 518-8338

**Winnipeg** (800) 892-5340



Platinum  
member



While All Weather at Home makes every effort to ensure that the information contained in this catalogue is accurate, we do not accept liability for any inaccuracies. This catalogue is subject to change, as well as errors and omissions, without notice or liability. **Photos shown throughout this catalogue are for illustrative purposes only.** This includes all displayed hardware, colours, finishes, and configurations, which may differ in availability and/or appearance from the final product. All doors come unfinished and do not include lockset/handle hardware unless otherwise specified. Any depicted windows may not represent actual All Weather at Home products. 2025 © All Weather at Home. All Rights Reserved.

**V4.1** 002020.12.18.24 Printed locally in Edmonton, AB, Canada 2025

