

# discover



WINDOW & PATIO DOOR COLLECTION



**ALL WEATHER  
WINDOWS**





## discover

- 4 Our Company Profile
- 7 Our Window Series
- 8 The Energy-Efficiency Experts
- 10 NAFS Ratings
- 11 V-weld Innovation
- 13 Frame Material
- 14 Colours & Finishes
- 16 Operating Styles & Configurations
- 18 Glass & Performance Ratings
- 20 Additional Options

## windows

- 22 APEX SERIES
- 24 Apex Alloy 9950
- 26 Summit 9700
- 28 Apex 9100
- 30 HORIZON SERIES
- 32 Alpine 6700
- 34 Ascent 6100
- 36 TERRAIN SERIES
- 38 Terra 2700
- 40 Terrano 2100
- 42 BASEMENT SERIES
- 44 Hopper 2200 & Double Slider 5600

## patio doors

- 48 Atmosphere
- 50 Vantage
- 52 Viscount

## exterior doors

- 56 Exterior Door Collection
- 59 Notes
- 62 Glossary of Terms



## A MESSAGE FROM OUR CO-CEOs

As the largest Canadian owned and operated window and door manufacturer, All Weather Windows is committed to you, our customer. What matters to you, matters to us. That is our promise.

And our promise is not just words. At All Weather Windows, we truly listen to our customers. Our team of experts is constantly working to understand what our customers value and consistently delivering on that value. Our award-winning line of products are made for you with care, by employees dedicated to providing the best possible product and the best possible customer experience.

Designed with you and your unique needs in mind, our products and services, including professional installation, are innovative, industry leading, and exceptional in every way. Our energy efficient windows and doors are tested & certified to meet stringent NAFS standards which are harmonized with AAMA, WDMA & CSA A440. With our continuous investment in research and development and our focus on operational excellence, we offer you, our customers, a guarantee that no other Canadian company can.

Trusted. Valued. Effortless. That is the All Weather Windows experience.

**COLIN WIEBE**  
co-CEO

**JILLENE LAKEVOLD**  
co-CEO



## OVER FOUR DECADES OF GIVING

At All Weather Windows, our philosophy for giving back is to improve the lives of families, one family at a time. Over the years, we have been fortunate to work with many incredible partners to help achieve our vision and assist those in need the best we can.

Our focus is to work with our partners to build sustainable and long-term support for those in need. We strive to empower long term success by providing assistance to students in industry related studies; helping organizations who support children and families; working with organizations that focus on mental health and provide opportunities for individuals with disabilities; and by devoting resources in the construction of shelter for those in need. We are proud to partner with organizations such as Habitat for Humanity, U School and Camp Nakamun.



The All Weather Windows 238,000 sq. ft. state-of-the-art manufacturing plant and showroom in Edmonton, Alberta, Canada. The facility houses our Edmonton sales, service, corporate services and support staff.

### PROUDLY CANADIAN

Founded in 1978 in Edmonton, Alberta, All Weather Windows is Canada’s largest privately owned window and door manufacturer. With three manufacturing



facilities, seven customer solution centres and close to 800 dealers, we proudly serve our partners and customers across Western Canada. Specializing in beautifully crafted windows and doors, our energy-efficient, sustainable and

weather-resistant solutions are built for the unique needs of Canadian homeowners, builders, dealers and contractors. We are also proud to be a Platinum member of Canada’s Best Managed Companies program, having received the award for the last 15 years in a row.



### WE LEAD THE SCENE FOR KEEPING IT GREEN

Canadian weather may have its ups and downs, but our environment needs to be respected and preserved. That’s why we promote sustainable initiatives by partnering with key environmental organizations and building councils like the Canada Green Building Council, Canadian Home Builders’ Associations, Canadian Standards Association, NRCan and Built Green Canada.

We live our sustainable values as an ENERGY STAR® program ambassador. We were awarded the Sustained Excellence Award in 2018 and Manufacturer of the Year five times in the last decade. Most recently, we received the ENERGY STAR® Special Recognition award in 2023 for our continuous commitment to energy savings.





# discover our series

Choosing your windows can be confusing and difficult. We have made it easier by creating three product categories that are based specifically on your needs and how you shop: Apex, Horizon and Terrain.

**Apex** series windows offers premium solutions, peak performance and the widest range of customizable options to choose from, bringing both style and comfort to any home.

**Horizon** series is our mid-range offering. It has less options than our Apex series but still enough choice for those who are seeking value for their money.

**Terrain** series makes performance affordable. It has the fewest available options and offers All Weather Windows quality at an affordable price.

## **APEX** 9000 SERIES

### **PRODUCTS:**

- 9950 Apex Alloy
- 9700 Summit
- 9100 Apex

## **HORIZON** 6000 SERIES

### **PRODUCTS:**

- 6700 Alpine
- 6100 Ascent

## **TERRAIN** 2000 SERIES

### **PRODUCTS:**

- 2700 Terra
- 2100 Terrano



Our series offer different levels of customization. Explore those options on the following pages and discover the All Weather Windows difference.

# the energy-efficiency experts

All Weather Windows prides itself on being an industry leader when it comes to manufacturing energy-efficient, high-performance windows and doors.

This includes ensuring that our products meet and exceed local and national building codes as well as stringent energy-efficiency standards. We offer a full range of **NAFS** (AAMA/WDMA/CSA 101/I.S.2/A440, North American Fenestration Standard) and **NFRC Certified** windows and doors, ensuring the products you choose are tailored to your geographic location and conditions while providing maximum value and comfort for your home.



For more information on NAFS ratings and standards, please see page 10 of this catalogue or speak to an All Weather Windows representative.

For energy-efficient glass performance ratings and technology, see page 18.

## GREEN REBATES

Homeowners who replace their windows and doors with new ENERGY STAR® certified products may be eligible for rebates. To find out what rebates are currently being offered, visit us at [allweatherwindows.com](http://allweatherwindows.com)



## WE KNOW CANADIAN WEATHER

Extreme weather is what separates good windows and doors from bad ones. As a company born and raised in Canada, we know what it takes to make products that stand up to our extraordinary seasons. From heavy west coast rain to unforgiving blizzards on the prairies and the bitter cold of the north, our doors and windows have been rigorously tested for every climate in every possible weather.

From multiple insulated air chambers and welded corners on our uPVC windows, to dual and triple pane glass with Low-E coatings, we can help create a custom product package that exactly matches your needs.

## OPTIONS FOR INSULATED CONCRETE FORM (ICF)

With the desire for increased energy-efficiency and Net Zero homes on the rise, ICF construction is more popular than ever. ICF homes are built using high-density foam blocks which are then filled with concrete. The outcome is increased energy-efficiency and overall insulation value (R-Value) of your home.

All Weather Windows offers products and options to maximize the benefits of ICF construction. These include high-efficiency triple pane glass with multiple Low-E coatings, glass that is recessed towards the interior of the home and increased jamb depths to accommodate ICF wall thickness.

## ENERGY STAR®

Research from Natural Resources Canada indicates that because of the Canadian climate, we spend far more money each year on heating than we do on cooling our homes — adding up to a lot of wasted money.

Luckily, installing ENERGY STAR certified windows can put a stop to this by significantly cutting energy consumption. It can also save three quarters of a tonne of greenhouse gas emissions annually. That's equivalent to the carbon offset of planting 80 trees. It's also why our windows are built to the highest energy efficient standards, consistently earning us ENERGY STAR awards year after year.



# what is NAFS?

The North American Fenestration Standard (NAFS) is designed to combine the window and door testing and ratings process into a harmonized North American Standard. It has been incorporated into the National Building Code of Canada and implemented across Canadian provinces.

NAFS Certification requires stringent standards be met for:

- » Air tightness
- » Water penetration resistance
- » Structural performance under wind loads
- » Forced entry resistance

*All Weather Windows offers NAFS tested and certified windows and doors, available in nearly every product series and configuration\*. Each NAFS certified product is clearly labelled, outlining the PG value and any specific ratings such as water and air resistance values.*

ALL WEATHER WINDOWS	
CONFORMS to AAMA/WDMA/CSA 101/1.5.2/A440-08/11 & CSA A440S1-09	
Product Line:	Hinged Fibreglass Door
Type:	INSWING
Configurations:	D, S-D-S, Garden Door
Panel Size:	3/0 x 6/8
Insert Size Tested:	22" x 64"
CLASS:	R-PG45
SIZE TESTED:	2875 mm X 2073 mm
Positive Design Pressure (DP):	2160
Negative Design Pressure (DP):	2160
Water Test Pressure (Pa):	260
Canadian Air Infiltration Exfiltration Level:	A3
Refer to local building code authority having jurisdiction to determine specific performance requirements prior to installation.	
<b>DO NOT REMOVE UNTIL FINAL INSPECTION</b>	

## PERFORMANCE GRADE & CLASS

Ratings are based on a combination of a product's structural properties and its ability to resist water. As a result, a single numeric rating is assigned to each product. This rating is called the **PERFORMANCE GRADE (PG)**.

NAFS has also categorized the application of fenestration products into four groups. Each of these groups is called a **PERFORMANCE CLASS**. Each class requires products that meet a minimum performance grade.

The performance classes and applicable minimum performance grades are:

- R:** Residential (one and two family) - minimum PG15
- LC:** Light Commercial (low rise and multi-family dwellings) - minimum PG25
- CW:** Commercial Window (low rise and multi-family dwellings, higher loads and larger sizes) - minimum PG30
- AW:** Architectural Window (mid to high rise buildings, high exposure conditions) - minimum PG40

To help you determine NAFS requirements for your region, please visit [www.fenestrationcanada.ca/calculator](http://www.fenestrationcanada.ca/calculator)

# discover v-weld innovation

All Weather Windows is proud to be one of the first manufacturers in North America to offer the groundbreaking technology of V-weld as part of our Apex window series. No other window offers such exceptional performance in keeping the outside elements from seeping into a home – virtually eliminating air and water leaks.

## V-WELD IS MORE THAN JUST A FANCY SOUNDING NAME

Conventional windows use mechanical mullions joined with gaskets and silicone, which contract and expand with temperature differences. This can lead to separation between joints, causing air and water leaks. To eliminate this, V-weld Apex windows are fusion-welded together leaving no gaps, cracks, spaces, slits or any other synonyms that water can seep through. This manufacturing process provides superior frame integrity and ensures better performance than conventional combination windows in water and air tests.

### V-WELD WINDOW TECHNOLOGY

Fusion welded combination window without the use of screws



### TRADITIONAL WINDOW TECHNOLOGY

Combination window is joined together with screws

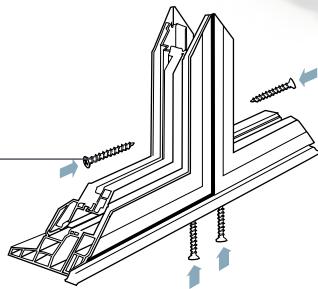

V-weld is available on Apex Alloy 9950 & Apex 9100 series windows.



# choose your frame material

New windows increase comfort and add a touch of beauty and elegance to your home, while helping you save on energy bills. They can also add tremendous curb appeal, increasing the resale value.

Choosing the right windows for your home shouldn't feel overwhelming. To help you choose the perfect windows that deliver the appearance and performance you want, start by selecting the exterior finish for your uPVC windows. Each type of colour application offers a specific look, benefits and options.

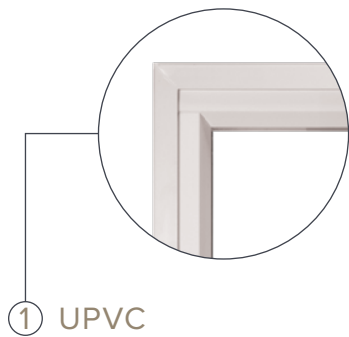

Our Unplasticised Polyvinyl Chloride (uPVC) windows are energy efficient, durable, and resistant to moisture and corrosion.

Frames also reduce heat loss, while insulating sound—ensuring an energy efficient, quietly comfortable home. Plus they're virtually maintenance free, with no need to paint, stain or refinish.

uPVC is available on our Apex, Horizon and Terrain Series of windows.

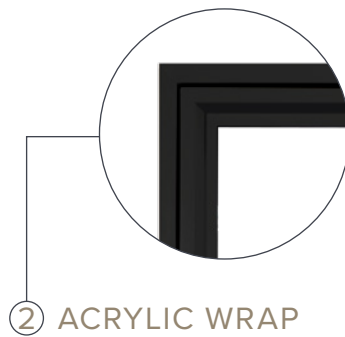

The perfect harmony of style and durability, high-performance acrylic-based wrap provides our customers with an array of exterior and interior colour options previously not possible for uPVC windows.

This beautiful and long-lasting alternative has been used in Europe for decades, and All Weather Windows is proud to offer this process to our customers in the Canadian marketplace.

Acrylic wrap is available on our Apex, basement 5600, and Ascent 6100 window series, along with our Vantage patio doors.

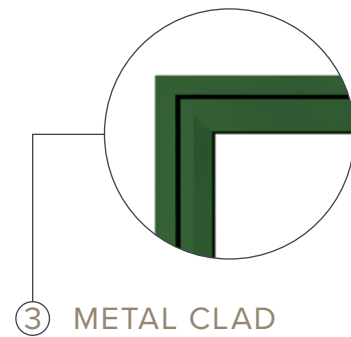

Create a statement by upgrading from uPVC to our award winning Metal Clad uPVC windows.

With bold styling and a variety of exterior colour choices, these windows combine the strength and elegance of aluminum cladding with all the benefits of a fusion-welded uPVC frame. The result is superior durability and energy efficiency. And just like our uPVC windows, they're virtually maintenance free.

Metal Clad uPVC is available on our Apex Alloy 9950 windows.

# choose your colour

Who says windows have to be boring? Express yourself with bold, beautiful colour.

Forget about the old standard in home design. New home builds have beautiful touches that add character and individuality, and the interiors are just as carefully styled. There's a demand for homes with curated style, character and colour—both inside and out.

## UPVC COLOURS

All of our uPVC windows come with a white uPVC interior and exterior. A wicker uPVC option is available on Apex 9100, Apex 9950, Summit 9700 and Vantage patio doors.

### INTERIOR & EXTERIOR UPVC COLOURS



## METAL CLAD EXTERIOR COLOURS

Available on our Apex Alloy 9950 window series, aluminum cladding is applied to the exterior of the uPVC window frame.

### EXTERIOR METAL CLAD COLOURS\*



## WHAT IS ACRYLIC WRAP?

Acrylic wrap is a high-performance acrylic-based product that is permanently bonded to the uPVC window frame. It is weather and UV resistant and retains its finish and colour throughout its service life. The wrap can be easily wiped clean and resists chalking, cracking and fading.

## ACRYLIC WRAP COLOURS

Exterior acrylic wrap is available on the Summit 9700, Apex 9100, Ascent 6100 (jet black only), 5600 Double Basement Slider (jet black only) and the Vantage patio door.

Interior acrylic wrap is available on Apex Alloy 9950, Summit 9700 (jet black only), Apex 9100 and the Vantage patio door (jet black only).

### EXTERIOR WRAP - STANDARD SOLID

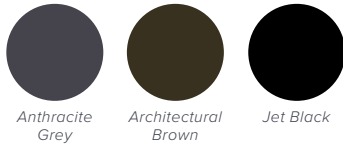

*Anthracite Grey*    *Architectural Brown*    *Jet Black*

### EXTERIOR WRAP - PREMIUM SOLID<sup>1</sup>

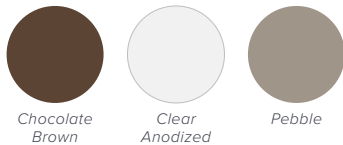

*Chocolate Brown*    *Clear Anodized*    *Pebble*

### EXTERIOR WRAP - PREMIUM WOODGRAIN<sup>1</sup>

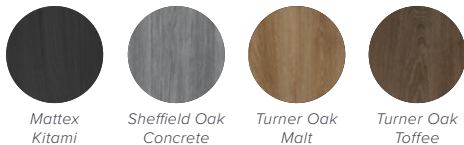

*Mattex Kitami*    *Sheffield Oak Concrete*    *Turner Oak Malt*    *Turner Oak Toffee*

### INTERIOR WRAP<sup>1</sup>

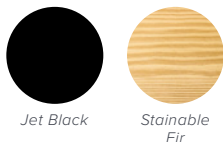

*Jet Black*    *Stainable Fir*

### COLOUR COMBINATIONS

INTERIOR COLOURS <sup>2</sup>	EXTERIOR COLOURS											
	White uPVC	Wicker uPVC	Jet Black	Arch. Brown	Clear Anodized	Chocolate Brown	Anthracite Grey	Pebble	Mattex Kitami	Sheffield Oak Concrete	Turner Oak Malt	Turner Oak Toffee
White uPVC	•	•	•	•	•	•	•	•	•	•	•	•
Wicker uPVC		•	•	•	•	•	•	•	•	•	•	•
Jet Black	•	•	•				•		•	•	•	•
Stainable Fir	•	•	•				•		•	•	•	•

<sup>2</sup>Summit 9700 and Vantage patio door are available with jet black interior wrap only.

<sup>1</sup>Additional lead times and up-charges may apply.

NOTE: uPVC components are white on all colours other than wicker. Not all interior colours are available with all exterior colours. Colour samples shown are for illustrative purposes only and may appear different on actual product.

# choose your operating style

When choosing windows, consider the energy efficiency of each window operating style, as well as the weather conditions in your city.



## **FIXED**

A fixed window is a casement or awning window that doesn't open.



## **PICTURE**

Picture windows do not open. They offer a low-profile frame to maximize glass surface, allowing a beautifully clear, unobstructed view.

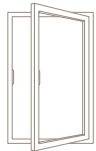

## **CASEMENT**

Hinged on the side, casement windows swing outward like a door, providing excellent air circulation into your home. They are also one of the most energy efficient operating windows because of their tight seal when closed.



## **AWNING**

Like a casement window, an awning window is hung horizontally. Hinged on top, it swings outward, shielding from the rain while providing good ventilation and constant airflow. Like the casement window, it is also one of the most energy efficient operating windows.

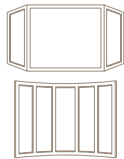

## **BAY & BOW**

Bay and bow windows allow you to expand an area in your home. Made up of a combination of windows attached at an angle, these windows extend beyond the wall, opening up any room.



## **SINGLE HUNG**

With a bottom sash that slides up, the single hung window allows controlled airflow into your home.



## **SLIDER**

The slider window has one or more sashes that slides open horizontally.



# choose your configuration

From urban geometric shapes to rustic ski chalet angles, the possibilities are endless.

If you're considering something more distinctive, All Weather Windows can help you create a unique combination of windows to suit both your personality and your home.

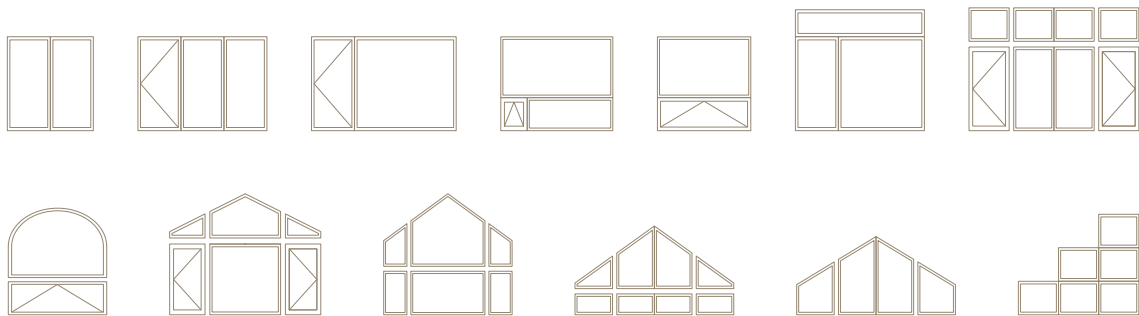

# choose your glass



Good design and correct installation are important factors in ensuring energy efficient windows, but glass performance plays the biggest role.

All Weather Windows offers a variety of energy-efficient glass options and technologies to ensure maximum comfort in any climate. With dual and triple pane configurations and multiple Low-E coating options, our glass keeps the summer heat out and the winter heat in.

## SUN OR SHADE?

If you prefer to take advantage of the sun's heat from your south and west-facing windows, consider glass with a higher solar heat gain (SHGC). Alternatively, choosing glass with a lower SHGC will keep the sun's heat out, leaving your home cool and comfortable, reducing cooling costs.

## GLASS PERFORMANCE RATINGS

Glass Name	Heat System	Description	METRIC*		IMPERIAL*			Visible Light	Ultraviolet Block	
			U-Value	R-Value	U-Value	R-Value	SHGC			
Clear	Dual	Dual pane, clear glass, no coatings	2.73	0.37	0.48	2.08	0.76	81%	42%	
	Tri	Triple pane, clear glass, no coatings	1.77	0.56	0.31	3.23	0.70	75%	52%	
Low-E		HS1-C180	Dual pane, one Low-E coating, Argon	1.48	0.68	0.26	3.85	0.69	79%	71%
		HS2-C180	Triple pane, one Low-E coating, Argon	1.04	0.96	0.18	5.56	0.61	73%	76%
		HS3-C180	Triple pane, two Low-E coatings, Argon	0.76	1.32	0.13	7.69	0.56	70%	87%
Sunstop		HS4-C270	Dual pane, one SunStop coating, Argon	1.41	0.71	0.25	4.00	0.37	70%	86%
		HS5-C270	Triple pane, one SunStop coating, Argon	1.05	0.95	0.19	5.26	0.34	64%	88%
		HS6-C270	Triple pane, two SunStop coatings, Argon	0.71	1.41	0.12	8.33	0.31	55%	96%
System V		HS1V-C180/i89	Dual pane, two Low-E coatings, Argon	1.19	0.84	0.21	4.76	0.62	77%	73%
		HS4V-C270/i89	Dual pane, one Low-E & one SunStop coating, Argon	1.14	0.88	0.20	5.00	0.36	69%	86%

**R-Value:** A measurement of the resistance of heat transfer through glass. The higher the R-Value, the better the window insulates against heat.

**Solar Heat Gain (SHGC):** The amount of the sun's heat that transfers through glass from the exterior to the interior side. The higher the solar heat gain, the more a window allows heat to pass through into a home.

**U-Value:** A measure of the rate of nonsolar heat flow through a material or assembly. The lower the U-Value, the greater a window's resistance to heat flow and the better its insulating value.

### PRO TIP: SAVE ON YOUR ENERGY BILL

Installing energy-efficient windows can reduce your energy costs by up to 16%.

## OUR GLASS TECHNOLOGY

A lot goes into making your windows as energy-efficient as possible, and it all starts with the glass. With over four decades of experience, we're experts in high-performance, energy-efficient glass. Discover the technology we use to maximize comfort and energy savings.

### DUAL PANE

Built with two panes of glass. Air between the panes acts as an insulation barrier, making your windows more energy efficient.

### TRIPLE PANE

Built with three panes of glass, triple pane units provide better insulation value compared to dual pane. This helps lower heating costs, virtually eliminates condensation and also acts as an excellent sound barrier.

### ARGON GAS

Argon gas is an inert, non-toxic, clear and odourless. Used to fill the space between panes of glass, argon gas minimizes convective currents that occur between glass panes. This reduces the tendency for glass to collect frost on cold winter days and improves the insulation quality of your windows.

### SYSTEM V (LOW-E i89)

System V glass delivers thermal performance similar to triple pane but only uses two panes of glass. Low-E coatings are applied to two of the four glass surfaces of the sealed unit, resulting in increased thermal performance.

### LOW-E (LOW-E 180)

Low-E 180 is a single coating applied to the surface of the glass and reduces heat loss by reflecting furnace heat back into a room. It also allows a large percentage of outside solar energy to pass through the glass into your home. This coating is most beneficial in the winter, since the heat provided by the sun can reduce the demands on your furnace. When combined with dual or triple pane glass, Low-E can offer between 35%-105% better insulating values than non Low-E glass. No other coating has a greater impact on reducing heating bills and improving the overall comfort of a home.

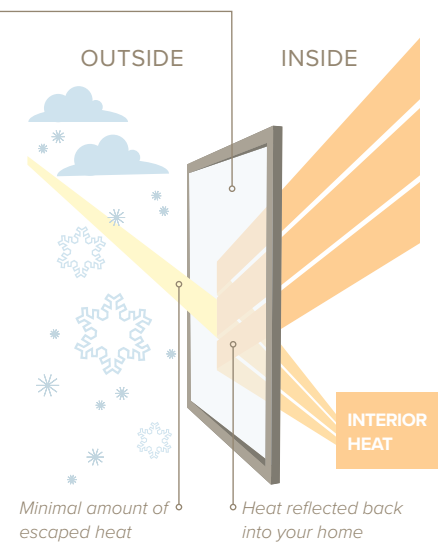

### SUNSTOP (LOW-E 270)

SunStop uses two layers of Low-E coating over top one another to block out the sun's heat, light and UV rays. Perfect for south and west facing windows, this coating keeps your home cool and comfortable in the summer to help reduce air conditioning costs. SunStop also improves the insulation properties of glass to help keep your home warmer in the winter when compared to clear glass.

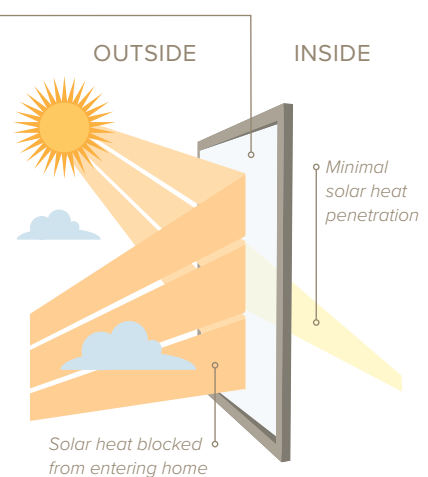

# choose your options

What would personalization be without options? Choose from brickmoulds, textured glass, grilles and hardware. Be bold or subtle—the choice is yours.

## BRICKMOULD

Enhance your home's curb appeal by adding exterior brickmould. Brickmould is attached to the outside exterior of your window and fills the gap between the window frame and your home's exterior finish. Brickmould is offered in all exterior acrylic wrap colours, in addition to white and wicker. It is available in the following 3 styles:

- 1 1/2" Renovation
- 2" Renovation
- 2" Back Set
- 1 1/2" New Construction (white only)



2" renovation brickmould in anthracite grey

## HARDWARE

Truly stand out with a selection of beautiful colours and finishes.



Encore folding handle

### WINDOW HARDWARE

Our Encore folding handles features a sleek, contemporary design. The discreet flush-profile handle provides a clean look and reduces interference with curtains and blinds. Best of all, Encore folding handles comes standard on all casement and awning windows.

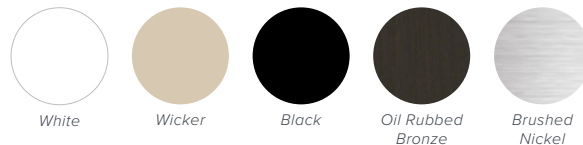

### PATIO DOOR HARDWARE

Our premier handle set is designed to accent larger patio doors with an elegant and easy-to-grasp shape that comes with double and true triple multipoint lock options. We also offer contemporary handle options for those wanting a sleek, modern style.



Allure

Signature Curved

Signature Contemporary

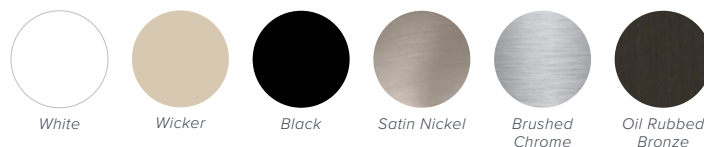

**Allure:** White, Wicker, Black

**Signature Contemporary:** White, Wicker, Black, Satin Nickel, Brushed Chrome, Oil Rubbed Bronze

**Signature Curved:** White, Wicker, Black, Brushed Chrome

## TEXTURED GLASS

Whether it's for increased privacy or a splash of personality, we offer several textured glass options for any style.



Rain



Obscure



Opaque

## INTERNAL GRILLES & SIMULATED DIVIDED LITES (SDL)

**Simulated Divided Lites (SDL)** are installed on the exterior of the glass surface to simulate the look of divided panes of glass.

**Internal Grilles** are installed between panes of glass, leaving the glass surfaces smooth and easy to clean.

### SDL & GRILLE PATTERNS

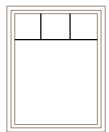

Ladder

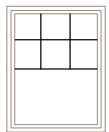

Double Ladder

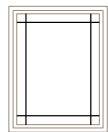

Perimeter

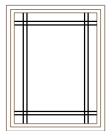

Double Perimeter

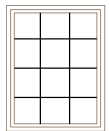

Rectangular

### SDL & GRILLE SIZES



**SDL Sizes:** • 7/8" • 1 1/4" • 2"



**Grille Sizes:** • 5/16" • 5/8" • 1" • 5/8" Georgian



### GRILLE FINISHES

GRILLE SIZE	Black	Gold	Lead	Patina	White	Wicker
5/16"	•	•	•	•	•	•
5/8"	•	•		•	•	•
1"		•		•	•	•
1" Split (white/black)	•					
5/8" Georgian		•	•	•	•	•

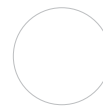

White



Wicker



Black



Gold



Lead



Patina





# discover our windows: **apex series**

You've reached the top of the mountain, where the view is the best. Where peak performance conquers. Where options feel endless. It doesn't get any better than this.

**APEX ALLOY 9950 | SUMMIT 9700 | APEX 9100**

PART OF OUR **APEX** WINDOW SERIES

# apex alloy

## 9950



### KEY FEATURES

- » Innovative V-weld technology
- » Aluminum exterior colour options
- » Interior acrylic wrap colour options
- » Durable spring-loaded screen
- » Multi-point casement lock system

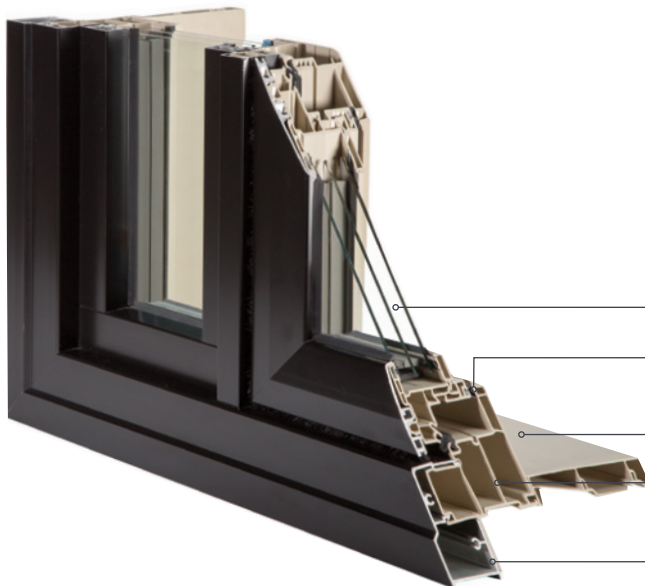

Optional triple pane glazing

Automotive-grade weather stripping for a superior seal in all conditions

Optional interior acrylic wrap finishes

Fusion-welded 3 5/8" multi-chamber frame for improved energy performance

Optional 2" integrated brickmould



For a stunning home design—on the inside and out—our metal clad uPVC windows offer elegance, strength and durability.

Not only do our Apex Alloy 9950 windows eliminate all water and air leaks through the revolutionary V-weld technology, but they also come with a variety of bold exterior colour options and two stylish acrylic wrap interior colours for the ultimate in custom window styles.

Our 9950 windows are instantly noticeable with their sleek, elegant exterior, but they also offer benefits such as excellent energy efficiency and a virtually maintenance-free frame. Experience window luxury at its finest with the Apex Alloy 9950 series.

### OPERATING STYLES

*Apex Alloy 9950 is a casement series window and is available in several operating and non-operating styles.*

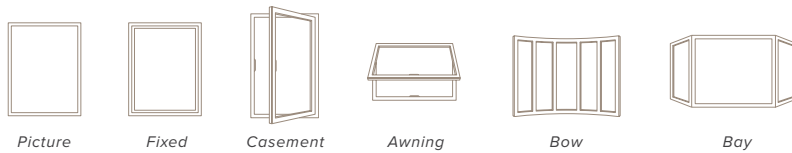

### EXTERIOR COLOUR

*Possibilities are endless with a wide selection of metal clad finishes. See page 14 for available colour options.*



### SDL & INTERNAL GRILLE

*Accent your style with interior grilles or exterior simulated divided lites (SDL). See page 21 for available styles.*



### GLASS

*Apex Alloy 9950 offers optional triple pane glass for increased performance. See page 18 for available options.*



### INTERIOR COLOUR

*Express yourself - both inside and out with our interior acrylic wrap. See page 15 for available options.*



### BRICKMOULD

*Apex Alloy 9950 features an optional integrated 2" brickmould, allowing for a wider range of window applications.*



### HARDWARE

*Featuring folding hardware for a clean and contemporary design. See page 20 for details and available finishes.*



PART OF OUR **APEX** WINDOW SERIES

# summit

# 9700



## KEY FEATURES

- » **NEW** optional jet black interior wrap
- » Exterior acrylic wrap colour options
- » Triple and dual pane glazing options
- » Double walled glazing stops
- » Renovation-friendly frame

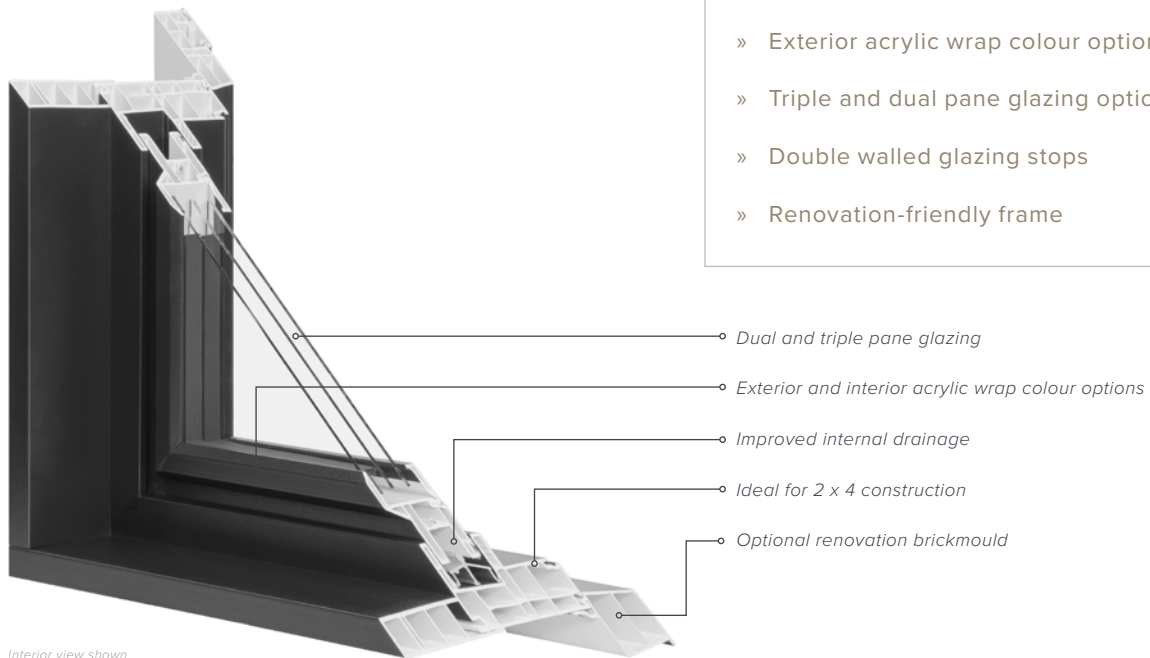

Interior view shown

For superior energy efficiency, exceptional insulating qualities and a stunning view, choose Summit. Oh, and did we mention exterior and interior colour?

Horizontal & vertical sliding windows are a great option when ease of use, durability and maximum ventilation are desired. The Summit 9700 profiles a sleek, narrow & modern frame that delivers superior energy efficiency ratings and structural integrity. The Summit 9700 comes with a renovation-friendly frame size along with other options that make it an ideal choice for all installations: new construction or renovations!

**NEW FOR 2023** Summit is now available with a jet black interior wrap!

### OPERATING STYLES

Summit 9700 is a slider series window and is available in several operating and non-operating styles.

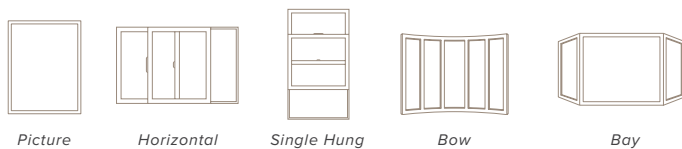

### EXTERIOR COLOUR

In addition to white or wicker uPVC, pick from 10 additional exterior wrap finishes. See page 15 for available options.



### SDL & INTERNAL GRILLE

Accent your style with interior grilles or exterior simulated divided lites (SDL). See page 21 for available styles.



### GLASS

Summit 9700 offers optional triple pane glass for increased performance. See page 18 for available options.



### INTERIOR COLOUR

Summit 9700 interior is available in white or wicker uPVC with optional jet black acrylic wrap. See page 15 for details.



### BRICKMOULD

Summit 9700 offers brickmould options for renovations and new construction. See page 20 for details and options.



# apex 9100



## KEY FEATURES

- » Innovative V-weld technology
- » Exterior acrylic wrap colour options
- » Interior acrylic wrap colour options
- » Durable spring-loaded screen
- » Multi-point casement lock system

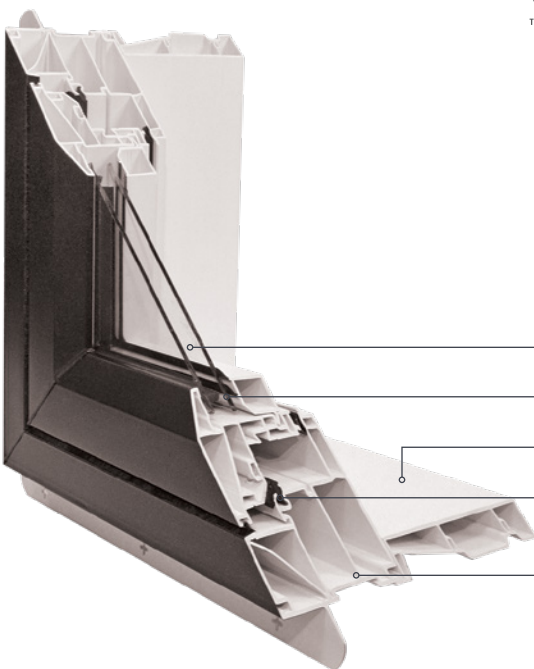

Optional triple pane glazing

Warm-edge spacer

Optional interior acrylic wrap finishes

Automotive-grade weather stripping for a superior seal in all conditions

Fusion-welded 3 1/4" multi-chamber frame for improved energy performance

Stylish and affordable, the Apex 9100 delivers great value and excellent energy efficiency.

Bring your home's interior and exterior design to the next level with acrylic wrap, our latest colour window offering. Acrylic wrap is a high-performance, durable film for interior or exterior use that adds to a home's appearance on the inside and out. The film is weather and ultraviolet resistant and retains its finish and colour throughout its service life.

### OPERATING STYLES

Apex 9100 is a casement series window and is available in several operating and non-operating styles.

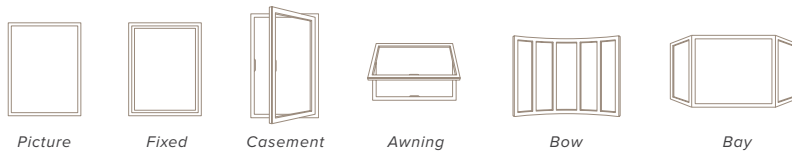

### EXTERIOR COLOUR

In addition to white or wicker uPVC, pick from 10 additional exterior wrap finishes. See page 15 for available options.



### SDL & INTERNAL GRILLE

Accent your style with interior grilles or exterior simulated divided lites (SDL). See page 21 for available styles.



### GLASS

Apex 9100 offers optional triple pane glass for increased performance. See page 18 for available options.



### INTERIOR COLOUR

Express yourself - both inside and out with interior acrylic wrap. See page 15 for available options.



### BRICKMOULD

Apex 9100 offers brickmould options for renovations and new construction. See page 20 for details and options.



### HARDWARE

Featuring folding hardware for a clean and contemporary design. See page 20 for details and available finishes.







# discover our windows: **horizon series**

You are gazing at the horizon, the point where mountain and terrain meet. Where customizable options meet value for money. Broaden your horizon and explore new possibilities.

**ALPINE 6700 | ASCENT 6100**

# alpine 6700

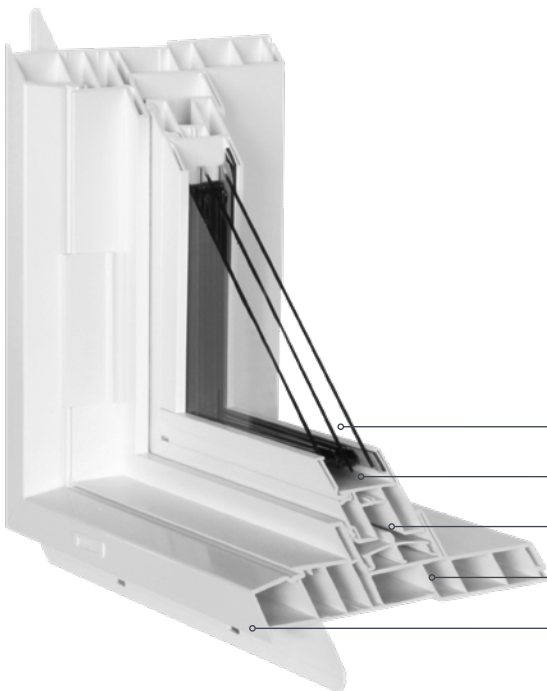

## KEY FEATURES

- » Triple pane glass with true 1/2" airspace
- » Superior energy performance
- » Unique one piece base frame design
- » Improved strength & internal drainage
- » Clean, modern look

- *Optional triple pane glazing*
- *Sealed unit centered within the frame*
- *Dual tandem rollers*
- *6 1/2" & 7 1/2" one piece base frame*
- *Integrated uPVC drip lip*



Take uPVC performance and value to the next level with Alpine's unique one piece base frame for superb strength and performance.

Enjoy enhanced curb appeal with eye-catching Alpine windows, which offer great durability and resistance to water and air infiltration without sacrificing beauty. Make the most of an attractive combination of energy efficiency, low maintenance, comfort and value with the Alpine uPVC windows—saving you money while keeping your home warm when it's cold outside.

Plus, because of Alpine's one piece base frame design, glass is positioned in the centre of your wall. This reduces condensation, increases ventilation and provides a warmer interior, saving you money.

### OPERATING STYLES

*Alpine 6700 is a slider series window and is available in both operating and non-operating styles.*



Picture



Horizontal



Single Hung

### CENTRED WALL PLACEMENT

*Positioning the glass in the centre of your wall improves air circulation in your home and overall energy efficiency.*

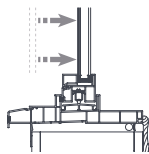

### SDL & INTERNAL GRILLE

*Accent your style with interior grilles or exterior simulated divided lites (SDL). See page 21 for available styles.*



### GLASS

*Alpine 6700 offers optional triple pane glass for increased performance. See page 18 for available options.*



### COLOUR

*Alpine 6700 comes with a white uPVC interior and exterior.*



# ascent 6100

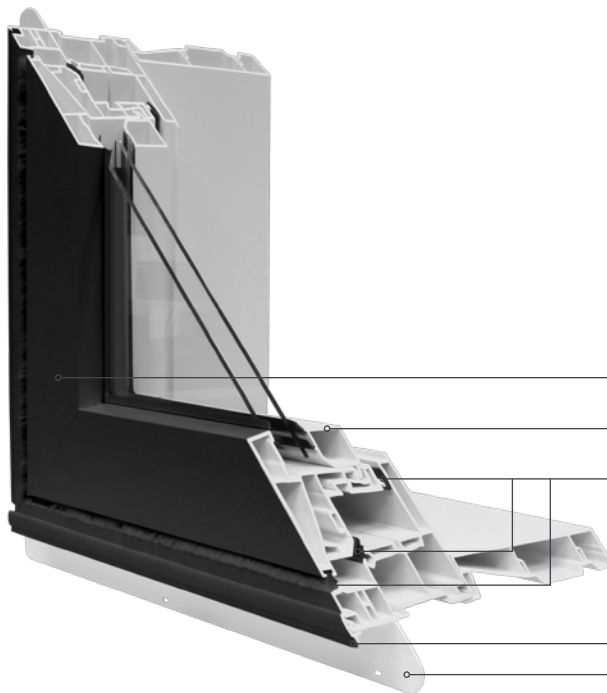

## KEY FEATURES

- » Jet black acrylic wrap exterior
- » Triple and dual pane glazing options
- » Interior glazing stops
- » Triple weather stripping
- » Clean, modern frame profile

◦ Jet black acrylic wrap exterior with contemporary profile

◦ Interior uPVC glazing stops

◦ Triple-seal Weatherstrip

◦ uPVC drip lip

◦ Integrated nailing fin

High performance, modern styling and good value should never come at a compromise. That's why we created Ascent.

Ascent is built for those who want energy efficiency, outstanding features and a trend-setting jet black exterior acrylic wrap. It offers multiple custom capabilities, including custom sizes, glass, brickmould, grille and SDL options. Together, these possibilities can help customers choose a design that compliments any style, truly taking your home's aesthetic to new heights.

### OPERATING STYLES

Ascent 6100 is a casement series window and is available in several operating and non-operating styles.

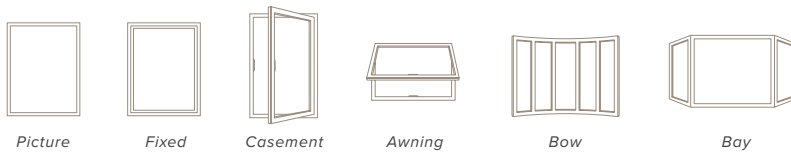

### EXTERIOR COLOUR

Ascent 6100 comes with a jet black acrylic wrapped exterior.



### SDL & INTERNAL GRILLE

Accent your style with interior grilles or exterior simulated divided lites (SDL). See page 21 for available styles.



### GLASS

Ascent 6100 offers optional triple pane glass for increased performance. See page 18 for available styles.



### INTERIOR COLOUR

Ascent 6100 comes with a white uPVC interior.

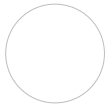

### HARDWARE

Featuring folding hardware for a clean and contemporary design. See page 20 for details and available finishes.







# discover our windows: **terrain series**

You're standing on solid ground. At the base of the summit. It's a starting point, but quality is not forgone. You are in the presence of greatness.

**TERRA 2700 | TERRANO 2100**

# terra 2700



## KEY FEATURES

- » Large viewing area
- » Superior energy performance
- » Improved drainage and frame strength
- » Low maintenance uPVC frame
- » Great value

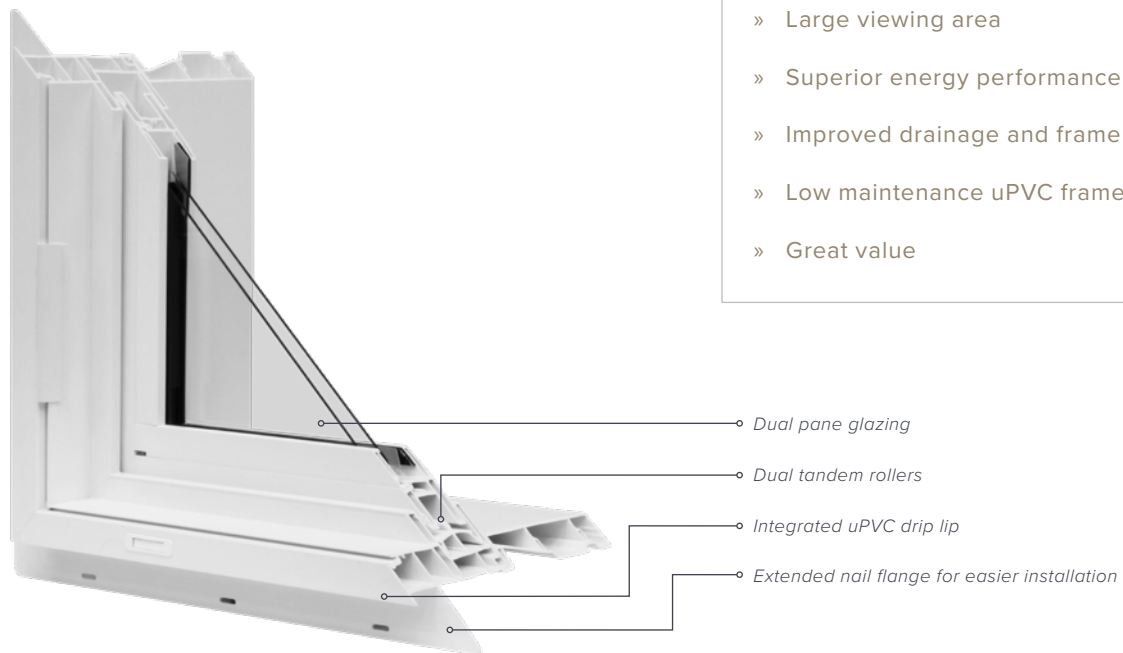

Great value, excellent water management and wide viewing area. Plus, all the benefits that come with low maintenance uPVC.

Enjoy the view with the large glass area of the Terra 2700 windows. These windows offer an excellent choice for those wanting great performance and the benefits of superior energy efficiency and a low maintenance frame. With excellent water and air management capabilities, superior strength and great value for money, the Terra windows are your best option for amazing quality that won't break the bank.

### OPERATING STYLES

*Terra 2700 is a slider series window and is available in both operating and non-operating styles.*



Picture



Horizontal



Single Hung

### SDL & INTERNAL GRILLE

*Accent your style with interior grilles or exterior simulated divided lites (SDL). See page 21 for available styles.*



### GLASS

*Terra 2700 includes dual pane glass with low-e coatings for increased performance. See page 18 for available options.*



### COLOUR

*Terra 2700 comes with a white uPVC interior and exterior.*



# terrano

# 2100



### KEY FEATURES

- » Optional triple pane glass
- » Interior glazed to minimize heat loss
- » Triple seal weather stripping
- » SDL & grille options
- » Exterior brickmould options

Optional triple pane glazing with a true 1/2" airspace

Interior glazed to minimize heat loss and increase energy efficiency

Triple seal weather stripping

Optional brickmould options



We don't believe that you have to compromise quality and performance to get good value on windows.

Built for those who want premium energy efficiency and outstanding features at an affordable price, Terrano 2100 really is the whole package. We offer multiple custom capabilities—including size options, glass types, grille types and grille design options—so customers can choose windows that compliment any style of home. With its clean lines and sleek profile, Terrano 2100 provides a stylish, contemporary look at a price that is just as appealing.

### OPERATING STYLES

*Terrano 2100 is a casement series window and is available in several operating and non-operating styles.*

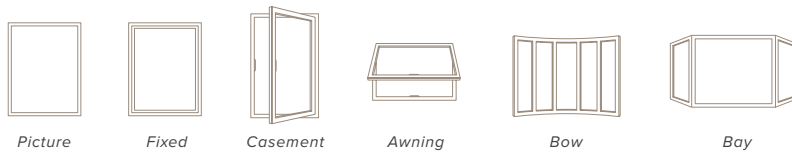

### SDL & INTERNAL GRILLE

*Accent your style with interior grilles or exterior simulated divided lites (SDL).*  
See page 21 for available styles.



### GLASS

*Terrano 2100 offers optional triple pane glass for increased performance.*  
See page 18 for available styles.



### BRICKMOULD

*Terrano 2100 offers brickmould options for renovations and new construction.* See page 20 for details and options.



### COLOUR

*Terrano 2100 comes with a white uPVC interior and exterior.*



### HARDWARE

*Featuring folding hardware for a clean and contemporary design.* See page 20 for details and available finishes.







# discover our windows: **basement series**

Whether you are looking to bring fresh air into your recreation room, need pass-through space for large objects, or to meet fire escape codes for basement bedrooms, we have the window that's right for you.

**HOPPER 2200 | DOUBLE SLIDER 5600**

# basement 2200 & 5600



## 2200 HOPPER



## 5600 DOUBLE SLIDER



### KEY FEATURES

- » Energy efficient
- » Superior airflow control
- » Removable screen & sashes
- » Great water & air management
- » Durable & affordable

Removable sashes and screens designed to meet fire escape codes for basement bedrooms

High quality, maintenance free uPVC frame with integrated nail flange

Optional triple pane glazing (5600 Double Slider only)

Optional jet black acrylic wrapped exterior (triple pane 5600 Double Slider only)

All Weather Windows offers a variety of options ideal for basement applications that are secure, energy efficient and designed to meet your home's unique needs.

Our hopper style basement window opens to a complete net clear opening, allowing you the flexibility to bring building materials (such as drywall) into the basement, and meets fire escape egress codes with smaller sized units.

Our double slider has two operational sides, sliding from side to side. Both sashes can easily be removed for cleaning and to create a larger net clear opening. This double slider also comes with an optional jet black acrylic wrapped exterior.

### OPERATING STYLES

*Our Basement Series windows are available in both a double slider or a top hinge awning (hopper) configuration.*

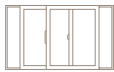

Double Slider



Hopper

### INTERNAL GRILLE

*Customize your glass with interior grilles for a truly customized look. See page 21 for available styles.*



### GLASS

*Dual pane is standard on basement windows. 5600 double sliders offer a triple pane option. See page 18 for available styles.*



### COLOUR

*Basement windows are available in white uPVC. Triple pane 5600 double sliders come with an optional jet black acrylic wrapped exterior.*







# discover the view with our patio doors

Maximize your view of the outdoors with maximum glass area while enjoying all the benefits of low maintenance, high-performance uPVC with our line of sliding patio doors.

**ATMOSPHERE | VANTAGE | VISCOUNT**

# atmosphere folding door



## KEY FEATURES

- » uPVC and aluminum frame options
- » Can be used as a pass-through window with a 36" minimum height
- » Exterior and interior colour options
- » Dual and triple pane glazing
- » Widths of 2 to 12 panels

- Slimline frame design for maximum viewing space
- 3-point multi-lock systems with one-hand operation
- Dual and triple pane glass with Preserve™ Protective Film
- Optional BRIO retractable screen
- Configurations from 2 to 12 panels wide



## Create wide open spaces with the Atmosphere folding door - the perfect space solution!

Blend your outdoor and indoor space with the Atmosphere folding door, offering an innovative solution for residential and commercial applications. The slim profile gives a clean and contemporary appearance while also allowing an abundance of light into your indoor space.

With a minimum frame height of 36", Atmosphere can be used as a **pass-through window**. This folding, open-style window allows you to bring the outdoors in to create an unobstructed, seamless space. Open your kitchen to an outdoor space to entertain your family and guests, or use it to easily move large furniture in and out of a room. The possibilities are endless!

### CONFIGURATIONS

Atmosphere folding doors are available in widths of 2 to 5 panels with a uPVC frame, while the thermally broken aluminum frame offers widths of 3 up to an impressive 12 panels wide, all with several operating styles.

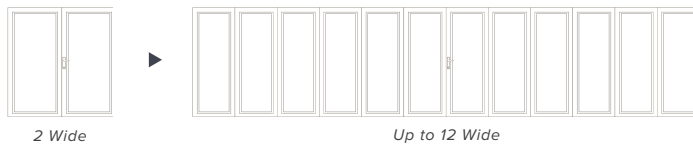

### FRAME MATERIAL

Atmosphere is available with both uPVC and thermally broken aluminum frame construction.

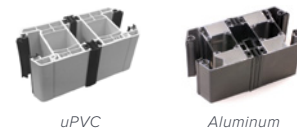

### GLASS

Available in dual or triple pane with low-E and argon gas, all glass panels include Preserve™ Protective Film.



### UPVC FRAME COLOURS

For uPVC doors, the frame is available in white with optional jet black acrylic wrap for the exterior and interior.



### ALUMINUM FRAME COLOURS

Aluminum doors come with a standard bone white or black painted frame, with additional custom finishes available.<sup>2</sup>

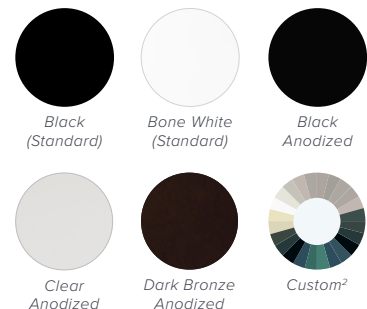

### HARDWARE

Atmosphere folding door includes a contemporary handle design available in two stylish finishes.

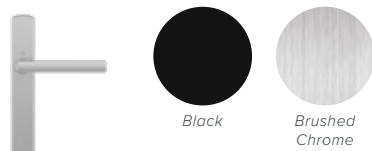

### RETRACTABLE SCREEN

BRIO retractable screens are measured and pre-cut to fit exact door dimensions. Available in black.



scan here to learn more and see all options

<sup>1</sup>Black interior acrylic wrap is only available when black exterior wrap is chosen.

<sup>2</sup>Additional charges and extended lead times apply for all painted frames.

# vantage patio door



## KEY FEATURES

- » Triple pane glazing option
- » Unique Quad Seal interlock system
- » Exterior & interior acrylic wrap options
- » Dual and triple multipoint lock system
- » Premium hardware styles & finishes

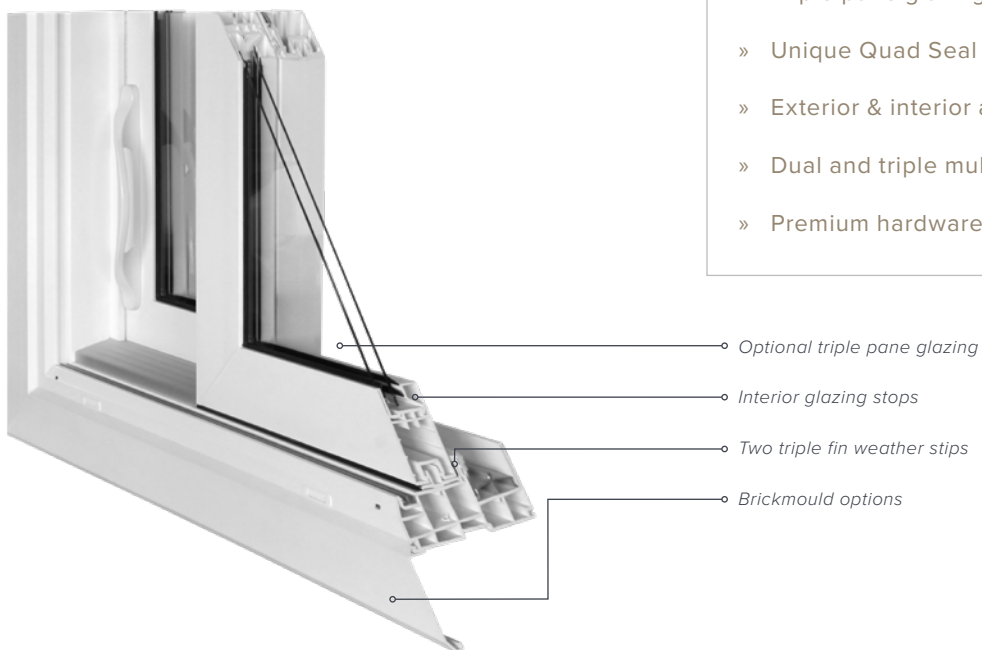

Bring the beauty of the outdoors inside with the Vantage patio door. Best of all, Vantage is available with exterior and interior acrylic wrap.

Created to help homeowners enjoy a clear, unobstructed view of their backyard, Vantage really is the whole package. With superior energy efficiency, multiple customizations, and a variety of exterior colour options, the Vantage is an excellent option for those seeking a stylish, high-performing patio door.

As part of a more energy efficient home package, the Vantage patio door is offered with the option to upgrade to triple pane glass. Triple pane glass prevents heat loss and provides superior soundproofing to keep a home peaceful and warm year round. Vantage also comes with a true fixed sash for an innovative, balanced appearance.

### CONFIGURATIONS

Available in 2, 3 & 4 wide configurations. Offset and double-opening options are available (limited to certain sizes/configurations).



### EXTERIOR COLOUR

In addition to white or wicker uPVC, pick from 10 additional exterior wrap finishes. See page 15 for available options.



### INTERNAL GRILLES

Accent your style with interior grilles. See page 21 for available styles.



### GLASS

Vantage offers optional triple pane glass for increased performance. See page 18 for available options.



### INTERIOR COLOUR

Express yourself - both inside and out with jet black interior acrylic wrap in addition to white and wicker uPVC.



### HARDWARE

Customize your patio door with one of 3 sleek, modern designs available in 6 elegant finishes. See page 20.



### INTERNAL BLINDS

Add extra privacy to any home with cordless, maintenance free internal blinds. Available in white and slate grey.



### BRICKMOULD

Vantage offers brickmould options for renovations and new construction. See page 20 for details and options.



# viscount patio door



## KEY FEATURES

- » White uPVC-welded sash & frame
- » Maximum glass viewing area
- » Nylon rollers with steel ball bearings
- » Optional keyed handle and foot lock
- » Great value



- White uPVC-welded sash & frame
- Updated fixed frame for large glass surface for maximum viewing area
- Optional key-lock handle & spring-loaded foot lock for added security
- Nylon rollers with stainless steel ball bearings for effortless sliding

Great value and style go hand-in-hand with optimal energy performance and maintenance free uPVC.

Available in white uPVC, our Viscount patio doors are a practical solution and offer great value for cottages and new homes. Enjoy a great view with effortless sliding functionality while also reducing water and air leaks with superior energy performance. Optional keyed-lock door handles and spring-loaded foot locks are available for added security.

### CONFIGURATIONS

Viscount patio doors are available in 2 & 3 wide configurations with your choice of sash operating direction.



2 Wide

3 Wide

### SDL & INTERNAL GRILLE

Accent your style with interior grilles or exterior simulated divided lites (SDL). See page 21 for available styles.



### GLASS

Viscount includes dual pane glass with low-e coatings for increased performance. See page 18 for available options.



### HARDWARE

Viscount offers optional keyed-lock handles and spring-loaded foot locks for added security.



### COLOUR

Viscount patio doors come with a white uPVC interior and exterior.







# discover our exterior doors

Front doors are a statement of style and reflect your unique personality. A bold and beautiful door will transform the look of your home and impact the mood and attitude of the entire space.

# first impressions matter

Beyond functionality, the type of door you choose can say a lot about who you are. Welcoming. Bold. Charming. These are just a few of the words that come to mind when thinking about the connection between door and homeowner.

All Weather Windows offers an extensive selection of exterior doors. From classic elegance to modern and contemporary styles, the possibilities are endless. Explore and choose from our authentic, high-quality and affordable exterior doors to make a lasting impression.



## CONTEMPORARY CHERRY

Simple and pure in design, our contemporary cherry collection achieves bold design through stainless steel embellishments or simple grooved lines. Made with high-quality cherry grain textured fibreglass, this door adds warmth and texture to any entry way.



*Create a personalized look with or without stainless steel accents.*



*Cherry grain brings warmth and modern texture to any entry way.*



## RUSTIC MAHOGANY

Our luxurious Rustic Mahogany textured fibreglass doors add warmth to your home while accentuating personal style with a distinctly European architectural feel. Channel old country charm with distressed, deep-grained mahogany texture.



*Luxurious, variable-depth woodgrain replicates real mahogany.*



*Deep, defined embossing mimics that of traditional hand-crafted wood doors.*



## VISTAGRANDE™

Instantly brighten any space with VistaGrande™ flush-glazed doors. Available in a number of glass options, VistaGrande™ doors offer a wider viewing area and cleaner appearance over traditional glass inserts.



*Factory flush glazing offers a cleaner, more refined appearance and wider viewing area.*



*From clear and textured glass, to internal blinds and SDL, create a door that's you.*





## TEXTURED WOODGRAIN FIBREGLASS

Featuring textured premium woodgrain fiberglass in three grain types, our doors include distinct architectural details, a reinforced lock area and thousands of customizable glass and panel combinations to choose from.



*Make a bold statement with variable-depth woodgrain patterns.*



*Detailed and well-defined panel profile adds architectural appeal.*



## SMOOTH FIBREGLASS

Smooth fiberglass doors combine the elegance of wood with the low-maintenance of fiberglass. They feature high-definition panel profiles that add architectural interest and elegance. The smooth surface is paintable and will not rust or dent.



*Smooth fiberglass surface is ideal for painting and will not rust or dent.*



*From decorative glass to grilles and panels, the hardest part is deciding.*

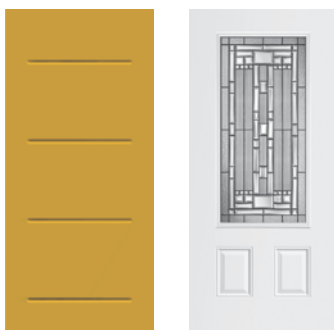

## PREFINISHED STEEL

Our steel doors feature high-definition decorative panels that closely replicate those of traditional hand-crafted doors. Steel doors are also the ultimate choice for security. Best of all, they boast a durable and convenient prefinished white or black surface.



*High-quality factory applied white or black painted surface.\*\**



*High-quality composite bottom rail and wood-edge construction resists rot and corrosion.*

## DISCOVER OUR COMPLETE DOOR COLLECTION

Get inspired and create a perfect door that speaks your style with our full Exterior Door Collection catalogue: **Inspire | Create**. Pick up your copy at any All Weather Windows location or from any authorized dealer.

Inspiration striking at 2 a.m.? View our complete online catalogue by scanning the QR code or visit us at [allweatherwindows.com](http://allweatherwindows.com)



← scan here to learn more

\*\*Door lite frames do not come prefinished and need to be painted to match the door. Black prefinished doors come with a black exterior only and are not available with door glass. The interior surface is prefinished in white only.









# glossary of terms

## **BRICKMOULD**

Brickmould is attached to the window or door frame on the exterior of a home. It covers the gap between your home's exterior and the window or door frame.

## **CLADDING**

Metal sheathing moulded and adhered to the outdoor sections of a window frame.

## **DRIP LIP**

An extruding edge that channels water away from the window and helps prevent it from dripping onto the wall under the window.

## **ENERGY STAR® CERTIFIED**

ENERGY STAR® is a third party assessment of the energy efficiency of products. All Weather Windows proudly manufactures ENERGY STAR® certified products including many that qualify for the "Most Efficient" program.

## **ENERGY RATING (ER RATING)**

An ER-rating is derived from solar heat gain, heat loss through frames, centre and edge of glass, and air leakage heat loss. The combined effect is measured in number of watts per square metre and is either positive or negative. A positive number represents a net heat gain and helps in reducing the home's heating costs. A negative number indicates that the product loses more energy through heat loss and air infiltration than it gains in solar energy absorbed from the sun (i.e. the home's heating system has to work harder in colder weather).

## **FRAME**

Outside part of a window consisting of jambs and sills that encloses a window sash.

## **GRILLE**

Cross-bars in between the panes of glass to give the impression the window is divided into a number of smaller panes.

## **INTERIOR CASING**

Trim or frame around the window on the interior.

## **INTERIOR GRILLES**

Decorative bars that are placed between the panes of glass.

## **JAMB**

Jambs are located inside the framing of a window, along the top and sides for structural support. Inferior jambs can be a weak point in a window, allowing for leaks or security concerns.

## **MULLION**

A mullion is the vertical piece that connects side-by-side units of a window.

## **PASSIVE SOLAR HEAT GAIN**

Solar heat that passes through a material and is captured naturally, not by mechanical means.

## **RAIL**

The horizontal part of a window sash on single-hung and double-hung windows.

## **RELATIVE HEAT GAIN**

A calculated relationship of heat gain (through a window system) that accounts for centre-of-glass U-Value and centre-of-glass shading coefficient based on a standard inside and outside temperature.

## **SASH**

The sash is the part of the window holding the glass in place when the window is being opened. They are available in sliding or hinged models, and create a tight seal with the frame when the window is closed.

## **SHADING COEFFICIENT**

A glass measurement comparing solar heat transmission, related to 1/8 inch clear glass.

## **SILL**

The flat bottom part of a window or door frame.

## **SIMULATED DIVIDED LITES (SDL)**

Decorative bars that are placed on the exterior of the glass. This gives the look of divided glass without compromising performance and energy efficiency.

## **SPACER**

Spacers are around the perimeter of the sealed glazing unit to provide uniform separation between the panes of glass in multi-paned windows. They absorb moisture from the trapped air in the space between the glass, preventing fogging and condensation.

## **STILES**

The vertical parts of a window sash (connected to rails, the horizontal parts).

## **TRANSOM WINDOW**

A window installed above a door, separated by a crosspiece.

## **U-VALUE**

A measure of the rate of non-solar heat flow through a material or assembly. The lower the U-Value, the greater a window's resistance to heat flow and the better its insulating value.

## **VISIBLE LIGHT TRANSMITTANCE**

The percentage or fraction of the visible light spectrum that is transmitted through the glass of a window or skylight as reduced by the sash material and reluctance of the glass.

## **WEATHER STRIPPING**

Weatherstripping is the component of a window that provides a seal between the frame and the sash. It is used to prevent air leakage. The better the weather stripping, the better the window performance.

# all weather windows

We manufacture a full line of quality windows and entry doors. Homeowners, contractors, dealers and builders rely on us for a comprehensive line of durable products that add value and beauty to any home. Let us be your first choice for all your window and door needs.





# discover

allweatherwindows.com  WEB

allweatherwindowscanada  FACEBOOK

awwcanada  INSTAGRAM

@AWWCanada  X

All Weather Windows  LINKEDIN

TOLL-FREE CANADA 800.638.5709

CALGARY 888.932.3387

EDMONTON 800.232.9407

LETHBRIDGE 877.327.0701

RED DEER 855.348.0701

REGINA 888.672.2202

SASKATOON 800.589.9899

VANCOUVER 800.518.8338

WINNIPEG 800.892.5340



Platinum member



While All Weather Windows makes every effort to ensure that the information contained in this catalogue is accurate, we do not accept liability for any inaccuracies. This catalogue is subject to change, as well as errors and omissions, without notice or liability. Doors are provided unfinished/unstained and without hardware unless otherwise noted. All photos are for illustration purposes only and depicted door frames and windows may not represent All Weather Windows products. All Weather Windows® is a trademark of All Weather Windows Ltd.

V1.10 002184.04.23.24

Printed locally in Edmonton, Canada 2024