

EXTERIOR DOOR COLLECTION

inspire | create



ALL WEATHER  
WINDOWS



The All Weather Windows 238,000 sq. ft. state-of-the-art manufacturing plant and showroom in Edmonton, Alberta, Canada. The facility houses our Edmonton sales, service, corporate services and support staff.

All Weather Windows manufactures a full line of quality windows and entry doors. Homeowners, contractors, dealers and builders rely on All Weather Windows for a comprehensive line of durable entry systems that add value and beauty to any home. Let us be your first choice for all your door and window needs.

## WE KNOW HOW TOUGH CANADA'S WEATHER CAN BE

Extreme weather is what separates good windows and doors from bad ones. As a company born and raised in Canada, we know what it takes to make products that stand up to our extraordinary seasons.

From heavy west coast rain to unforgiving blizzards on the prairies and the bitter cold of the north, our doors and windows have been rigorously tested for every climate in every possible weather outcome to meet North American Fenestration Standards (NAFS).

After all, just because you have to live with Canadian weather, doesn't mean it has to live with you.

## WE LEAD THE SCENE FOR KEEPING IT GREEN

Canadian weather may have its ups and downs, but our environment needs to be respected and preserved. That's why we promote sustainable initiatives by partnering with key environmental organizations and building councils like the Canada Green Building Council, Canadian Home Builders' Associations, Canadian Standards Association, NRCAN and Built Green Canada.

We live our sustainable values as an ENERGY STAR® program ambassador. We were awarded the Sustained Excellence Award in 2018 and Manufacturer of the Year five times in the last decade. Most recently, we received the ENERGY STAR® Special Recognition award in 2023 for our continuous commitment to energy savings.

# your dream door **starts here**

## inspire | create

PAGES 04 - 91

We know how much work goes into making beautiful, stylish and durable doors and choosing one should be an effortless process. That's why we've put together this inspirational collection of entry doors. You don't need to worry about the quality of your door - you simply need to decide which one is right for you.

To help you find the absolute best door to fit your vision and style, we want you to be inspired without feeling overwhelmed by technical jargon. That's why we've split our catalogue into two distinct sections: Inspire & Create.

The first section **INSPIRE** is dedicated to doing just that - inspiring the perfect match. At a glance, you will be able to narrow your choices down to doors that you love and rule out any styles that simply don't match your vision.

Explore door materials, glass styles and decorative door lite designs, while using product highlights to assist you in making the perfect selection to match your style and taste.

PAGES 92 - 131

Once you've found the perfect door, it's time to get creative and put all that inspiration to work. That brings us to **CREATE**.

In the Create section, you will find all the technical information necessary to see your vision come to life. From door slab sizing and rough openings, to frame material and hardware finishes, you'll find it all here. This section also serves as a quick and easy reference for comparing door styles, sizing and availability.

You will notice that all pages in the **INSPIRE** section refer to their corresponding page in the **CREATE** section, making it that much easier to build your dream door.

Be inspired. Get creative.



# INSIDE OUT

**VISTAGRANDE™** flush-glazed smooth fibreglass doors **34**  
**NAPLES®** glass **76** fir woodgrain textured fibreglass door **38**



## 04

- 06
- 24
- 25
- 28
- 30
- 32
- 34
- 36
- 38
- 40
- 42
- 44

## 92

- 94
- 96
- 98
- 99
- 100
- 101
- 102
- 103
- 104
- 119
- 122
- 124
- 125
- 126
- 130
- 131

## inspire

- New & Modern Door Highlights
- Choosing a Door
- Doors at a Glance
- Barrington® Sierra®
- Contemporary Cherry
- Rustic Mahogany
- VistaGrande™
- Craftsman Smooth
- Textured Fibreglass
- Smooth Fibreglass
- Steel
- Decorative Glass A-Z

## create

- Operating Styles, Handing & Swing
- Fire Rated Door System
- NAFS & ENERGY STAR®
- Entry Door System
- Multilock Hardware
- Grilles & SDL
- Brickmould, Hinges & Striker Plates
- Door Slab & Frame Finishes
- Style Matrix A-Z
- Slab Sizing
- Rough Openings
- How To Measure Your Door
- Door Planner
- Notes
- Door Lite & Panel Legend
- Index

# FIRST IMPRESSIONS MATTER

Exterior doors are a statement of style and reflect the homeowner's unique personality. A bold and beautiful door will transform the look of a home and impact the mood and attitude of the entire space.

Explore our line of modern and contemporary doors and choose from our authentic, high quality and affordable entry doors to make a lasting impression.





# new & modern

## door highlights



## SHAKE THINGS UP!

Available in smooth and fir grain textured fibreglass, our shaker doors are designed with today's home styles in mind. Pair with complementary interior doors and cabinets for a coordinated modern look throughout your home.

1 PANEL SHAKER fir woodgrain textured fibreglass door 38





2 PANEL SHAKER smooth fibreglass door 40



# NEXT LEVEL COLOUR.

Want a door that fits your custom-styled home perfectly? Or one that's completely unique and truly stands out? Personalize your doors with our factory paint and stain colour options for smooth and woodgrain textured fibreglass doors.

*Discover our pre-painted and pre-stained options on page 103*

FLUID glass 61 smooth fibreglass door 40 pre-finished in lime green



CONTEMPORARY CHERRY C601 cherry woodgrain textured fiberglass door with stainless steel lines 30 pre-finished in raven stain

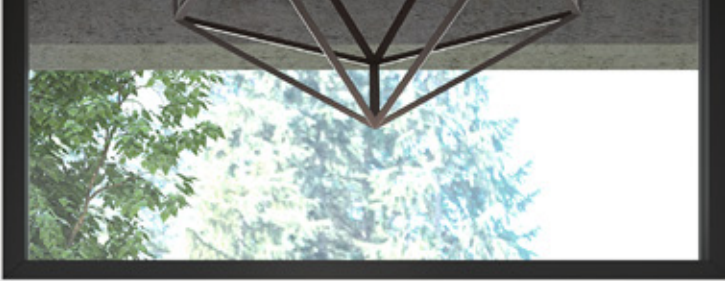

## EXQUISITE TEXTURES

Inspired by everything from flowing water to tufted fabrics, textured glass draws the eye and evokes intrigue. It allows increased, filtered light while offering various levels of privacy.

**SOFT** glass 85 smooth fibreglass door 40



ZENITH glass 91 smooth fibreglass door 40 pre-finished in blue , full opaque glass sidelites and transom



## BRING ON THE LIGHT

Chic lines and flowing, natural light add an intriguing and welcoming atmosphere to any space in your home. With our wide selection of textured and decorative door glass, you can make your home exactly what it should be - yours.

OPAL glass 78 steel door 42



CELESTE glass 51 steel door 42

# GEO COLLECTION

Our Geo collection was born out of the marriage between modern and original styles. With its sleek lines, this collection places focus squarely on the harmony of its shapes.



*Linea  
Embossment*



*Oso  
Embossment*



*Soho  
Embossment*



*Vog  
Embossment*





OSO steel door 42 full clear glass sidelite



SOHO steel doors 42 full obscure glass sidelite and transom



LINEA fluid glass 61 steel door 42

Note: All doors in this catalogue come unstained/unpainted unless otherwise noted. Photos shown are for illustration purposes only.



# MID-CENTURY MODERN

With an emphasis on minimalistic design and functionality, our mid-century modern series radiates personality and is the ultimate statement for the design-conscious homeowner.

*Discover mid-century modern on page 75*



MID-CENTURY MODERN clear glass 71 smooth fibreglass door 40



## BASIC ISN'T SO BASIC

Who said basic isn't beautiful? Sometimes the most daring statements are made in the subtlest way. Flush doors perfectly compliment mid-century modern and art deco architecture, especially with a burst of colour.

**FLUSH** smooth fibreglass door 40 full clear glass sidelites pre-finished in slate



**FLUSH** smooth fibreglass door 40 full clear glass sidelite & transom

# choosing a door inspired by you

Beyond the functionality, the type of door you choose can say a lot about who you are. Welcoming. Bold. Charming. These are just a few of the words that come to mind when thinking about the connection between door and homeowner.

Choosing the right doors for your home shouldn't feel overwhelming. To help you choose the doors that deliver the appearance and performance you want, keep these three simple steps in mind as you explore our catalogue:



## 1 BE INSPIRED

Let your personal style and vision guide you in selecting the perfect door.

Think about your own personality. Do you like to make a statement or do you prefer a subtle effect? Is your home's style more classic or contemporary? Do you have a specific colour scheme in mind?

We have many options so take your time to be inspired and discover your style.



## 2 CHOOSE YOUR MATERIAL

Doors are built with a variety of material and each material offers its own benefits and aesthetic appeal.

Choose from woodgrain-textured fibreglass that has the appearance of real wood, smooth fibreglass that can be painted any colour, or one of our prefinished steel skin doors for added security.

Be sure to consider the right material to meet your individual needs for you and your home.

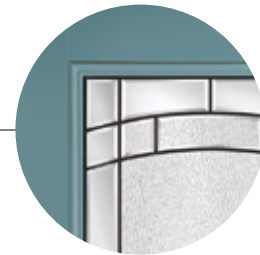

## 3 ACCENTUATE

This is when you can really begin to customize your door and bring your vision to life.

Choose from a variety of custom sidelites, designer transoms and decorative glass inserts while tying all the accents together by coordinating grille, casing and hardware colours.

Whatever the desired end product, these options can make the bold or subtle statement you're looking for.



# DOORS AT A GLANCE

## BARRINGTON® SIERRA® MAHOGANY TEXTURED FIBREGLASS

Taking inspiration from the craftsman style, Sierra introduces elegantly embossed panels for a bold take on a traditional look.



\$\$\$\$

## CONTEMPORARY CHERRY TEXTURED FIBREGLASS

Using NVD Technology, cherry grain doors achieve a wood grain texture that is indistinguishable from real wood.

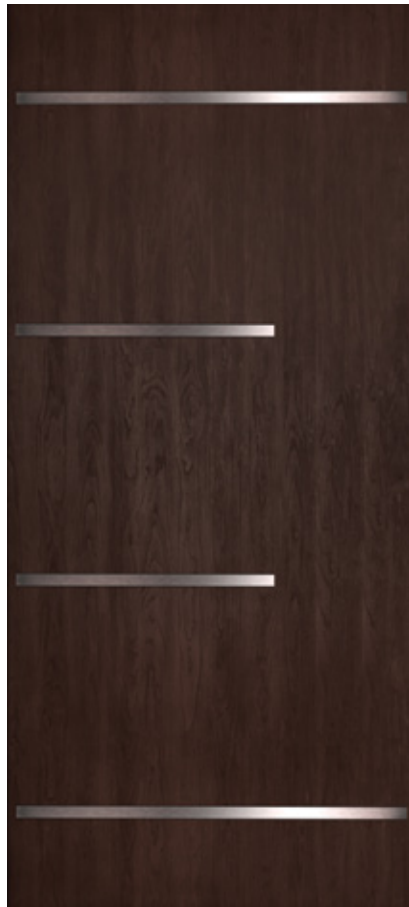

\$\$\$\$

## CONTEMPORARY CHERRY TEXTURED FIBREGLASS

Simple and pure in design, our contemporary cherry collection achieves bold, modern design with all the benefits of fiberglass.



\$\$\$



### AUTHENTIC EMBOSSING

*Deep, defined embossing mimics that of traditional hand-crafted wood doors.*



### STAINLESS STEEL EMBELLISHMENTS

*Stainless steel strips are inlaid directly into the fiberglass skin.*



### GROOVED LINES

*Gentle, recessed lines are engraved right into the fiberglass skin.*



### MATCHING STILES

*Real mahogany-capped, square edge stiles offer an authentic wood look.*

*discover more on p. 28*



### CONTEMPORARY CHERRY GRAIN

*Cherry grain brings warmth and modern texture to any entry way.*

*discover more on p. 30*

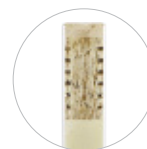

### OVERSIZED STILES

*Oversized 4-1/8" LSL stiles give added strength and help prevent warping.*

*discover more on p. 30*

# DOORS AT A GLANCE

## RUSTIC MAHOGANY TEXTURED FIBREGLASS

Our luxury textured fibreglass rustic doors add warmth to your home while accentuating personal style with a distinctly European feel.



\$\$\$

## VISTAGRANDE™ FIR TEXTURED & SMOOTH FIBREGLASS

Instantly brighten and beautify any space with wider, factory-flush glazing - you can truly bring the outdoors in.



\$\$\$

## CRAFTSMAN SMOOTH FIBREGLASS

With a pre-pigmented white skin, smooth craftsman doors are a beautiful, long-lasting alternative to steel entry doors.



\$\$\$



### AUTHENTIC EMBOSSING

*Deep, defined embossing mimics that of traditional hand-crafted wood doors.*



### LUXURY MAHOGANY GRAIN

*Detailed texture replicates real mahogany grain.*

*discover more on p. 32*



### CUSTOM FACTORY FLUSH-GLAZING

*Offers a cleaner, more refined appearance and wider viewing area.*



### INTERNAL MINI BLINDS

*Maintenance-free internal mini blinds provide privacy without losing your view.*

*discover more on p. 34*



### HYDROSHIELD TECHNOLOGY™

*Smooth skin craftsman entry doors will not dent, rust or delaminate.*



### CUSTOM FACTORY FLUSH-GLAZING

*Offers a cleaner, more refined appearance for an authentic craftsman look.*

*discover more on p. 36*

## TEXTURED WOODGRAIN FIBREGLASS

Featuring distinct architectural details, 3 authentic grain patterns, and endless customizable glass and panel combinations.



\$\$

## SMOOTH FIBREGLASS

With a smooth, paintable, low-maintenance fiberglass surface, these doors are sure to fit any architectural style.



\$\$

## PREFINISHED STEEL

Boasting high-definition panel profiles and endless glass options, our steel doors offer the most in flexibility and security.



\$

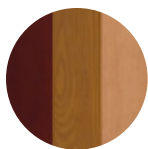

### MAHOGANY, OAK & FIR WOODGRAIN

*Make a bold statement with variable-depth woodgrain patterns.*



### HIGH-DEFINITION PANEL PROFILE

*Detailed and well-defined panel profile adds architectural appeal.*

*discover more on p. 38*



### HIGH-PERFORMANCE SMOOTH SURFACE

*Ideal for painting & will not rust or dent.*



### LIMITLESS CUSTOMIZATION

*From decorative glass to grilles and panels, the hardest part is deciding.*

*discover more on p. 40*



### PREFINISHED WHITE OR BLACK

*High-quality factory applied white or black painted surface.\*\**



### ROT-RESISTANT BOTTOM RAIL

*High-quality composite bottom rail and wood-edge construction resists rot and corrosion.*

*discover more on p. 42*

\*\*Door lite frames do not come prefinished and need to be painted to match the door. Black prefinished doors come with a black exterior only and are not available with door glass. The interior surface is prefinished in white only.



**BE  
BOLD**

Who says you need glass to make a statement? Create dramatic intrigue with a solid panel Barrington® Sierra® fiberglass door. After all, simple is beautiful.

BARRINGTON® SIERRA® 2 panel plank

Be bold. Barrington® Sierra® doors are the pinnacle of woodgrain solid-panel doors. Featuring all the benefits of Barrington luxury fibreglass, this series will be sure to impress for years to come.

### MAHOGANY WOODGRAIN TEXTURE

The fine, highly detailed look of mahogany adds sophistication and richness to any entry way



*Barrington Sierra mahogany woodgrain textured fibreglass pre-finished in Cedar stain*

### INSPIRED RUSTIC DESIGN

Vertical planks and soft arches echo rustic flair and authentic craftsmanship



*Barrington Sierra mahogany woodgrain textured fibreglass pre-finished in Raven stain*

### MATCHING WOOD STILES

Real mahogany-capped, true square-edge stiles offer an authentic wood look



*Barrington Sierra mahogany woodgrain textured fibreglass pre-finished in Mahogany stain*

### DOOR STYLES



Explore all available styles on page **117**

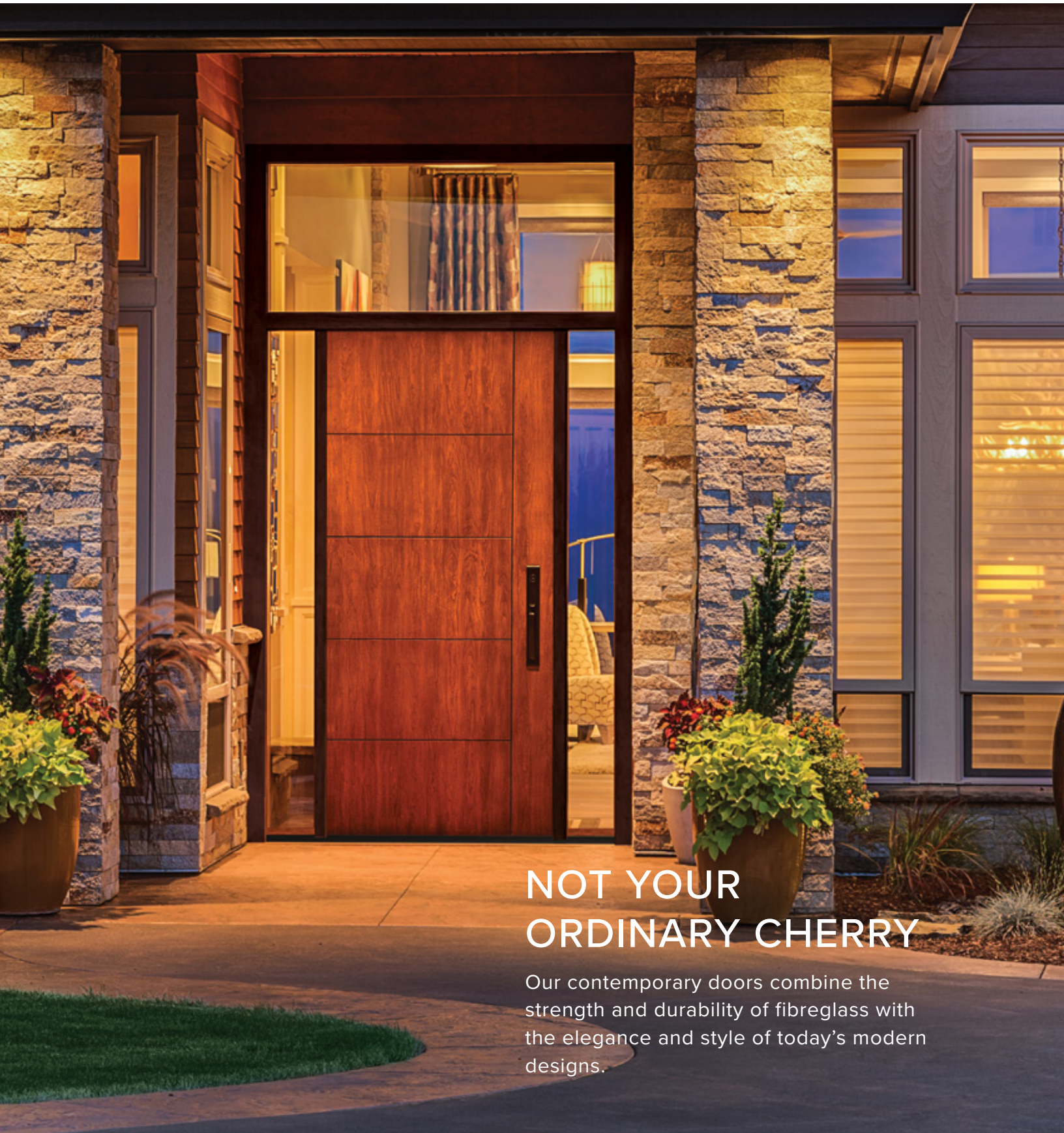

## NOT YOUR ORDINARY CHERRY

Our contemporary doors combine the strength and durability of fibreglass with the elegance and style of today's modern designs.

CONTEMPORARY CHERRY C501 textured fibreglass door with grooved lines

Simple and pure in design, our contemporary cherry collection achieves bold design through stainless steel embellishments or simple grooved lines. Made with high quality cherry grain textured fibreglass, this door adds warmth and texture to any entry way.

### VARIABLE-DEPTH CHERRY GRAIN TEXTURE

Cherry grain brings warmth with its deep, well-defined texture, perfect for any contemporary style

### GROOVED OR STAINLESS STEEL LINES

Stainless steel creates a bold, ultra-modern look, while simple grooves bring a refined and fresh style

### CONTEMPORARY LINES

Embellishments or not, the clean, symmetrical lines compliment any modern architecture

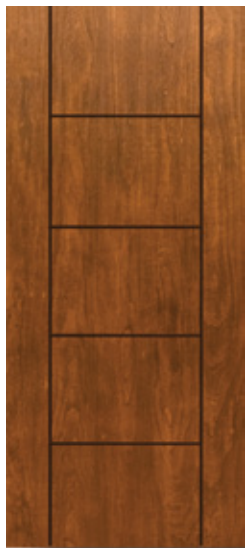

C500

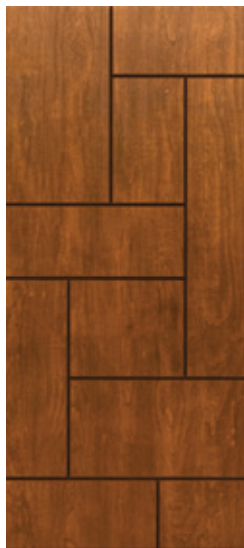

C528

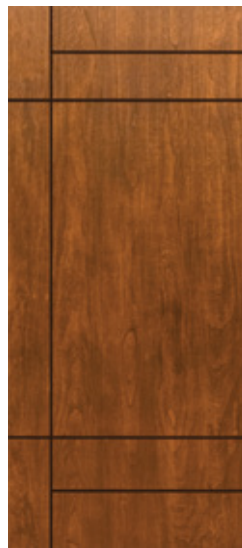

C536

#### GROOVED LINES

*Striking and refined, recessed grooved lines create a beautiful and refined style for the ultimate contemporary look*

#### GROOVED STYLES

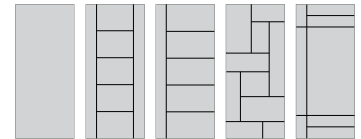

C605

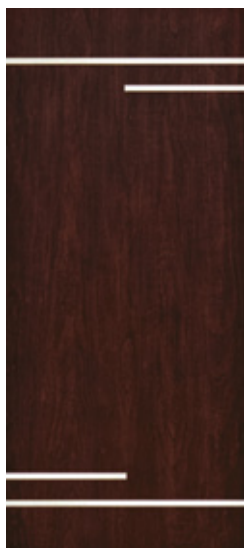

C602

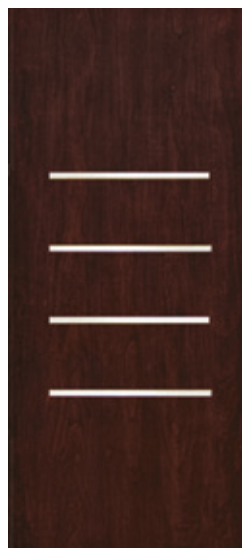

C604

#### STAINLESS STEEL LINES

*Bold and strong, stainless steel strips are embellished right into the fibreglass surface, perfect for any modern style*

#### STAINLESS STEEL STYLES



Explore all available styles on page **117**

Note: All doors in this catalogue come unstained/unpainted unless otherwise noted. Photos shown are for illustration purposes only.



## SIMPLY CHARMING

Inspired by the rural countryside, rustic mahogany echoes refined elegance.

RUSTIC MAHOGANY textured fibreglass 2 panel arch-top door



Our luxurious Rustic Mahogany textured fibreglass doors add warmth to your home while accentuating personal style with a distinctly European architectural feel. Channel old country charm with distressed, deep-grained mahogany texture.

**VARIABLE-DEPTH MAHOGANY GRAIN**

Detailed texture replicates the look of real mahogany wood grain for a truly rustic look

**AUTHENTIC PANEL EMBOSSING**

Deep, defined embossing mimics that of authentic hand-crafted wood doors

**DRAMATICALLY WIDE**

Rustic mahogany door slabs are available up to 42" widths on select styles

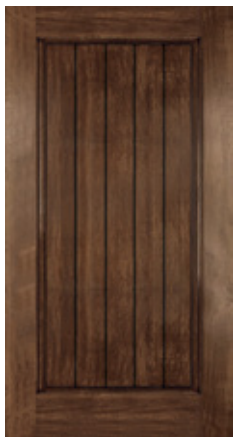

*1 panel plank*

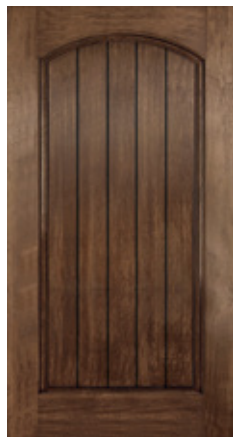

*1 panel arch-top plank*



*2 panel square-top plank*



*2 panel arch-top plank*



*2 panel arch-top*



*2 panel square-top*



*Pinehurst sidelite*

**DOOR STYLES**

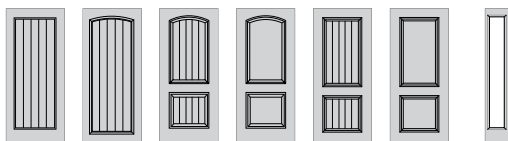

Explore all available styles on page **117**



## VISTA VIEWS

Create breathtaking views with wide, factory flush-glazed glass, truly bringing the outdoors inside.

PEAR 926 full lite with 152 full sidelites

Instantly brighten any space with VistaGrande™ flush-glazed doors. Available in a number of glass options, VistaGrande™ doors offer a wider viewing area and cleaner appearance over traditional glass inserts.

### SMOOTH & FIR GRAIN TEXTURED FIBREGLASS

Choose smooth fibreglass for a clean contemporary look, or rich fir grain for a craftsman feel

### MULTIPLE GLASS & STYLE OPTIONS

Personalize your view with integrated mini blinds, textured glass and SDL options

### FLUSH-GLAZED GLASS

No insert frame means no unsightly screws and a maximized glass viewing area



*Fir grain fibreglass with 926 full clear lite & 3-1/2" SDL*



*Smooth fibreglass with 926 full internal blind lite*



*Smooth fibreglass with 426 3/4 clear lite & 1-1/8" 6 lite SDL*

### GLASS OPTIONS



*Clear*



*Chord®*



*Internal mini blinds*



*Pearl*



*Pearl®*

Explore all available styles on page **118**



## CRAFTSMAN REDEFINED

With a paintable, smooth finish and a high definition panel profile, the Craftsman door exudes contemporary style while also offering the low-maintenance upkeep of fiberglass.

CLEAR 3 LITE SDL 24-1/2" x 16-5/8" lite

Enjoy the rustic charm of Craftsman doors: mission-styled for an authentic wood look. Craftsman Smooth Skin fiberglass entry doors are a long-lasting alternative to steel and use an exclusive Hydroshield Technology™ to resist dents, rust and delamination.

### HYDROSHIELD TECHNOLOGY™

Craftsman smooth fiberglass doors use proprietary technology to resist the elements and everyday wear

### PRE-PIGMENTED WHITE FIBREGLASS SKIN

Fully paintable fiberglass that stands the test of time and resists the appearance of scratches

### FLUSH-GLAZED GLASS

No insert frame means no unsightly screws and a maximized glass viewing area



Clear lite



Clear with 3 lite SDL



Clear with 6 lite SDL



Clear Sidelite



Clear Sidelite with SDL

#### MATCHING SIDELITES

Compliment your door with an equally stunning, matching sidelites. Available with clear glass and optional SDL, adding sidelites will be sure to take your door to the next level of grandeur and sophistication.

Explore all available styles on page **116**

Note: Craftsman smooth series doors cannot be combined with other craftsman panels offered by All Weather Windows due to its distinct panel and glass size.



MULTI-GRAIN  
ISN'T JUST  
A TYPE OF  
BREAD

With 3 distinct and detailed woodgrain textures to choose from, the only limit on style is your imagination.

CUZCO® 122 full lite in an oak textured slab with clear glass transom

Featuring textured premium woodgrain fibreglass in three grain types, our doors feature distinct architectural details, a reinforced lock area and thousands of customizable glass and panel combinations to choose from.

### MAHOGANY, OAK & FIR WOODGRAIN

Make a stunning entrance with oak, fir or mahogany variable-depth woodgrain texture

### SHAKER PANEL PROFILE

Craftsman style doors include beautifully recessed flat shaker panels for a real craftsman style

### HIGH-DEFINITION PANEL PROFILE

Detailed panels create the authentic and inviting look of a real wood door



Oak woodgrain texture with 106 1/2 Element® lite

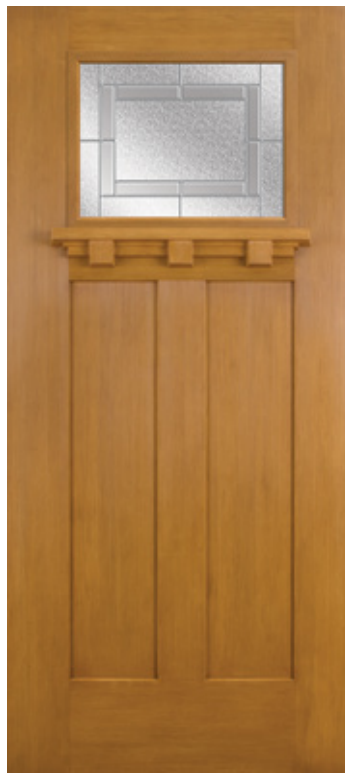

Fir woodgrain texture with 217 Focus lite & optional dentil shelf



Mahogany woodgrain texture with 122 full Kordella® lite



8 panel (Mahogany)



6 panel (Oak)

#### SOLID PANEL OPTIONS

Available in several solid panel styles in all three woodgrain textures that will seamlessly coordinate and compliment with any decor choice

#### DOOR STYLES

With so many options to choose from, it would be impossible to list them all here! Visit the door style matrix in the CREATE section of this catalogue to see all available door styles and configurations in this series

Explore all available styles on page 104

## SOPHISTICATED & POLISHED

The smooth, paintable surface of our fibreglass doors suit any style. From ultra-modern to rural farmhouse, you'll be sure to find the perfect match for the perfect look

PEAR 152 full lite with full glass clear sidelite



Smooth fibreglass doors combine the elegance of wood with the low-maintenance of fibreglass. They feature high-definition panel profiles that add architectural interest and elegance. The smooth surface is paintable and will not rust or dent.

### ENDLESS POSSIBILITIES

Choose from hundreds of glass, panel, and sizing combinations

### SHAKER PANEL PROFILE

Craftsman style doors include beautifully recessed flat shaker panels for a real craftsman style

### HIGH-DEFINITION PANEL PROFILE

Detailed panels create the authentic and inviting look of a real wood door



2 panel with  
404 3/4 Bolero lite



2 panel with 217 Frontier® lite  
& optional dentil shelf



1 panel with  
106 1/2 Channele lite



2 panel plank  
arch top



2 panel  
square top

### SOLID PANEL OPTIONS

Available in several solid panel styles that will seamlessly coordinate and compliment with any decor choice

### DOOR STYLES

With so many options to choose from, it would be impossible to list them all here! Visit the door style matrix in the CREATE section of this catalogue to see all available door styles and configurations in this series

Explore all available styles on page 104



## ULTIMATE VERSATILITY

From clean, modern lines to classic panels and decorative glass, steel doors give the widest range of door styles.

CHORD® 3 x 217 lites with full glass clear sidelite and transom

Our steel doors feature high-definition decorative panels that closely replicate those of traditional hand-crafted doors. Steel doors are also the ultimate choice for security. Best of all, they boast a durable and convenient prefinished white or black surface.

### HIGH-DEFINITION PANEL PROFILE

Detailed panels create a clean and inviting look



6 panel

### MODERN EMBOSSMENTS

Steel doors offer the latest in modern embossing and panel profiles



Vog panel

### ENDLESS POSSIBILITIES

Choose from hundreds of glass, panel, and sizing combinations

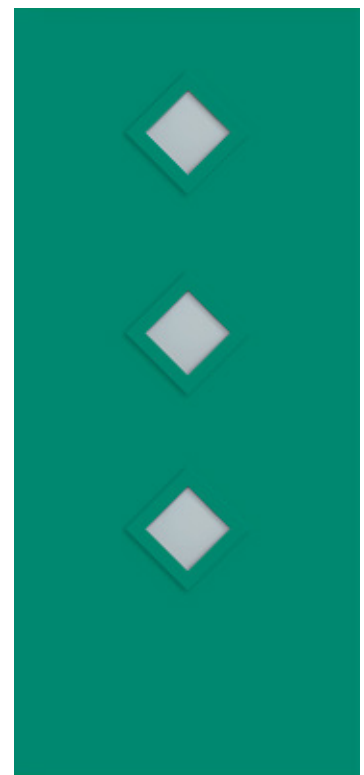

Mid-century modern with 808 diamond lites



Flush



2 panel square top

### PREFINISHED BLACK STEEL DOORS

A factory-painted black exterior easily creates a dramatic statement with your entry door

### DOOR STYLES

With so many options to choose from, it would be impossible to list them all here! Visit the door style matrix in the CREATE section of this catalogue to see all available door styles and configurations in this series

Explore all available styles on page 104

# ELEGANCE THROUGH GLASS

Accentuate the entrance of your home with our decorative door glass. Available on steel, smooth, and textured fibreglass doors, our decorative glass is sure to brighten up your space, increase your privacy, and improve your home's overall curb appeal.



ADELAIDE 404 3/4 lite in a smooth fibreglass slab

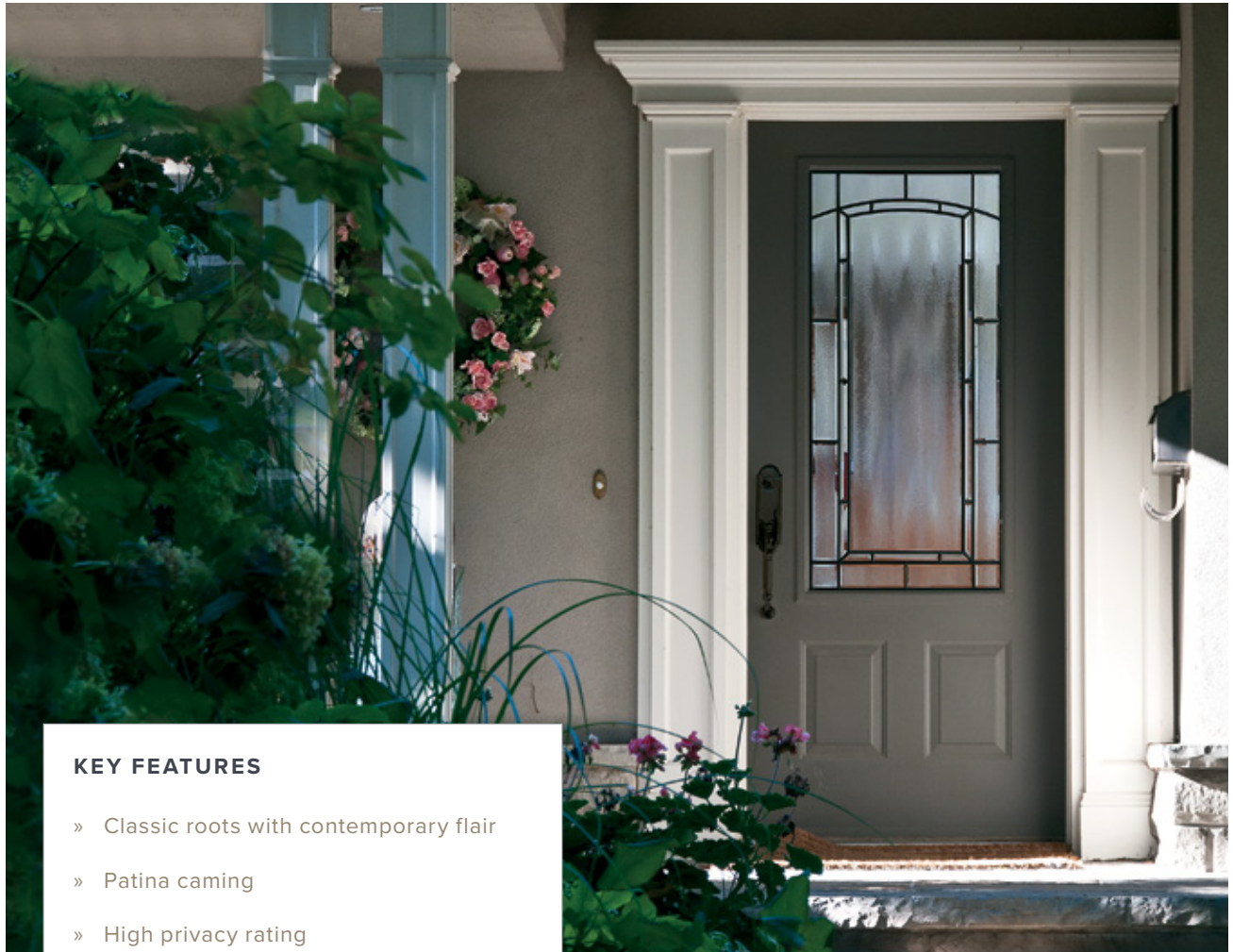

## KEY FEATURES

- » Classic roots with contemporary flair
- » Patina caming
- » High privacy rating



clear  
beveled  
glass

patina  
caming

sable  
beveled  
glass

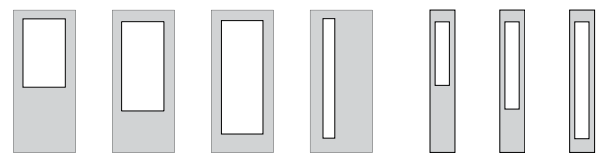

PRIVACY RATING

\$\$\$\$

1 2 3 4 5 6 7 8 9 10

least obscure

most obscure

Explore all available styles on page **104**

# ALYS

ALYS 122 full lite in a steel slab



## KEY FEATURES

- » Natural yet abstract design
- » High privacy rating
- » V-groove glass

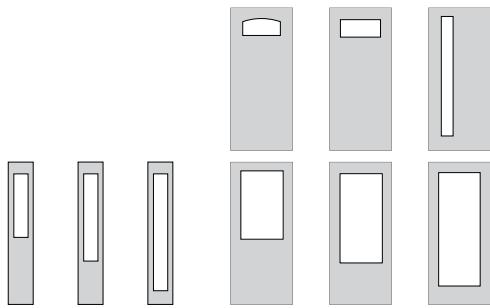

\$\$

## PRIVACY RATING



v-groove lines

sandblasted glass

Explore all available styles on page **104**

ARIMA 404 3/4 lite in a smooth fibreglass slab with clear glass transom



## KEY FEATURES

- » Elegant symmetrical composition
- » Great choice for classic bungalows
- » Patina caming

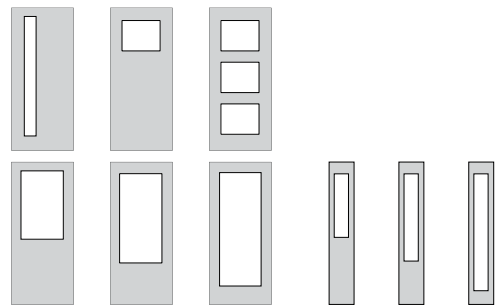
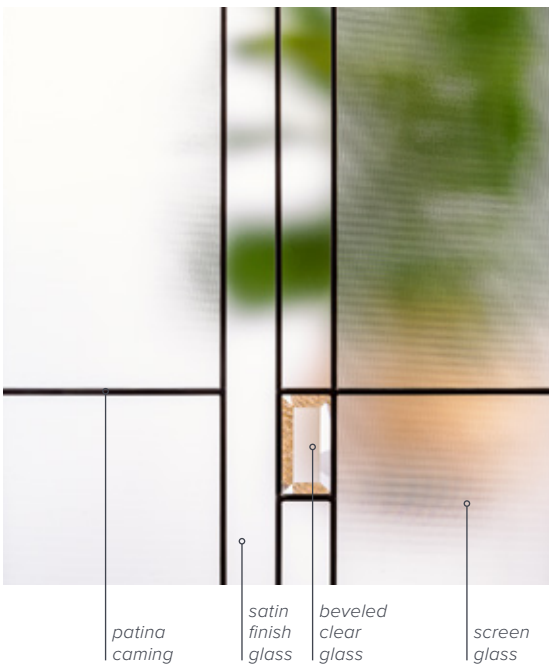

## PRIVACY RATING

\$\$\$



Explore all available styles on page **104**

# AZUR

AZUR 122 full lite in a steel slab with full glass clear sidelites

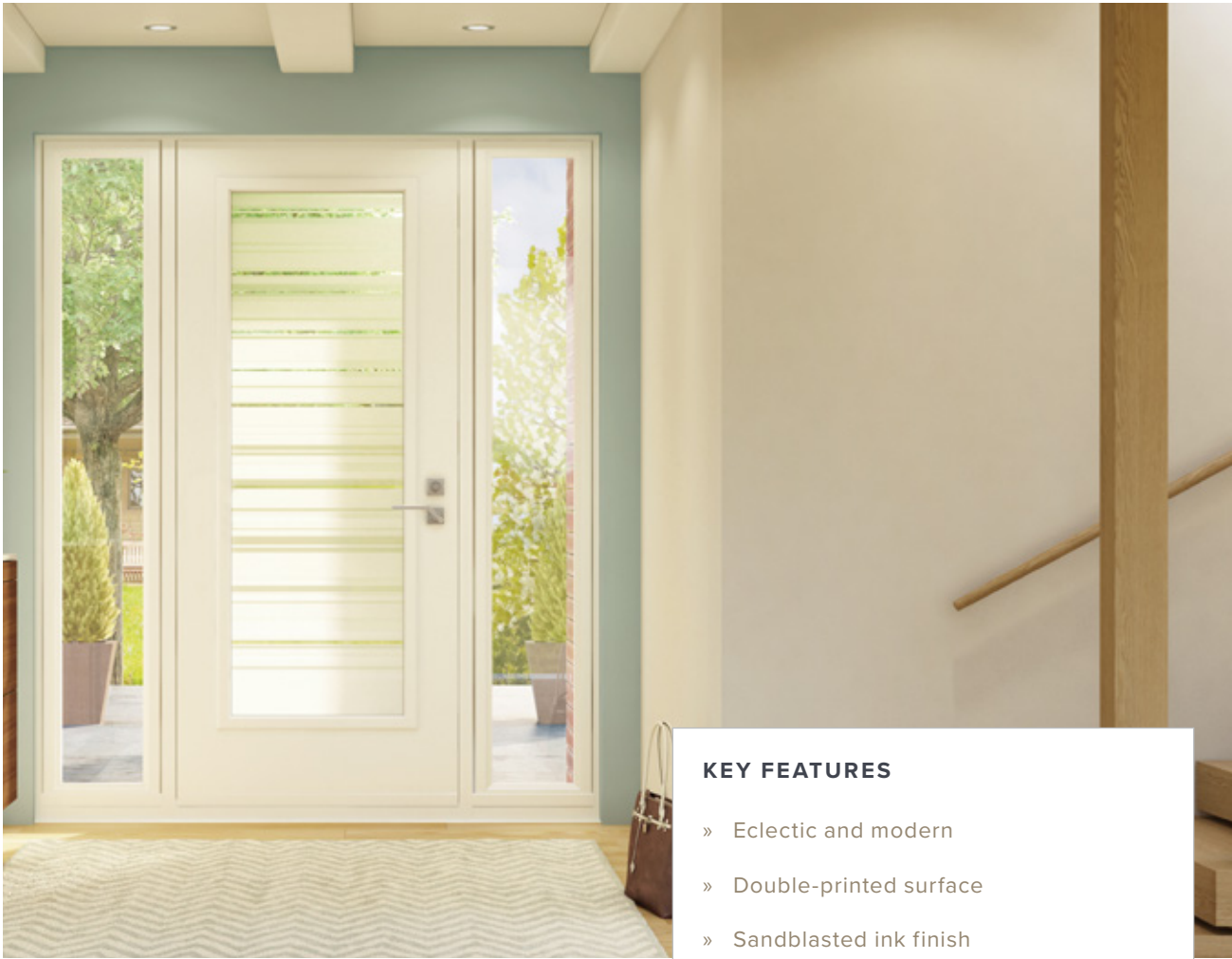

## KEY FEATURES

- » Eclectic and modern
- » Double-printed surface
- » Sandblasted ink finish

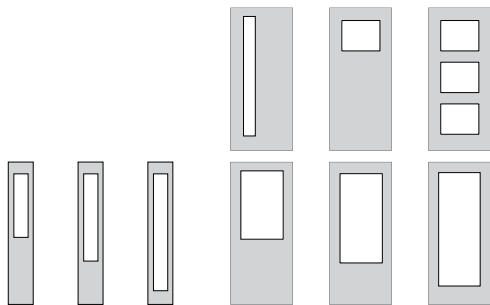

\$\$

PRIVACY RATING

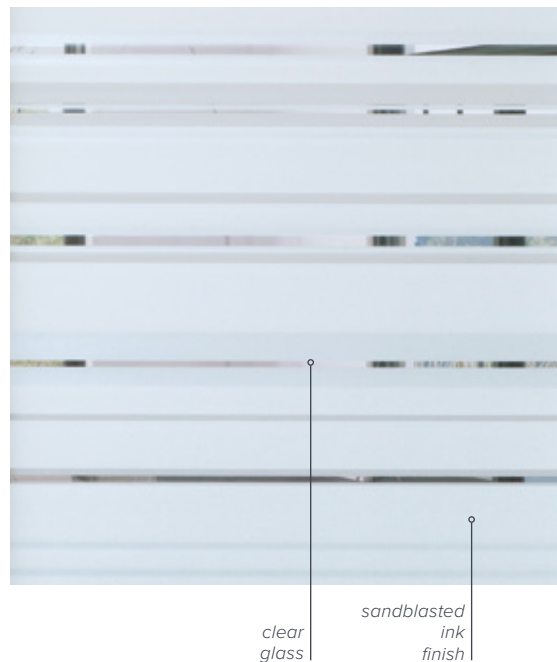
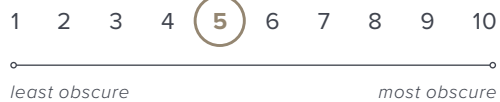

Explore all available styles on page **104**



BOLERO 122 full lite in a smooth fibreglass slab

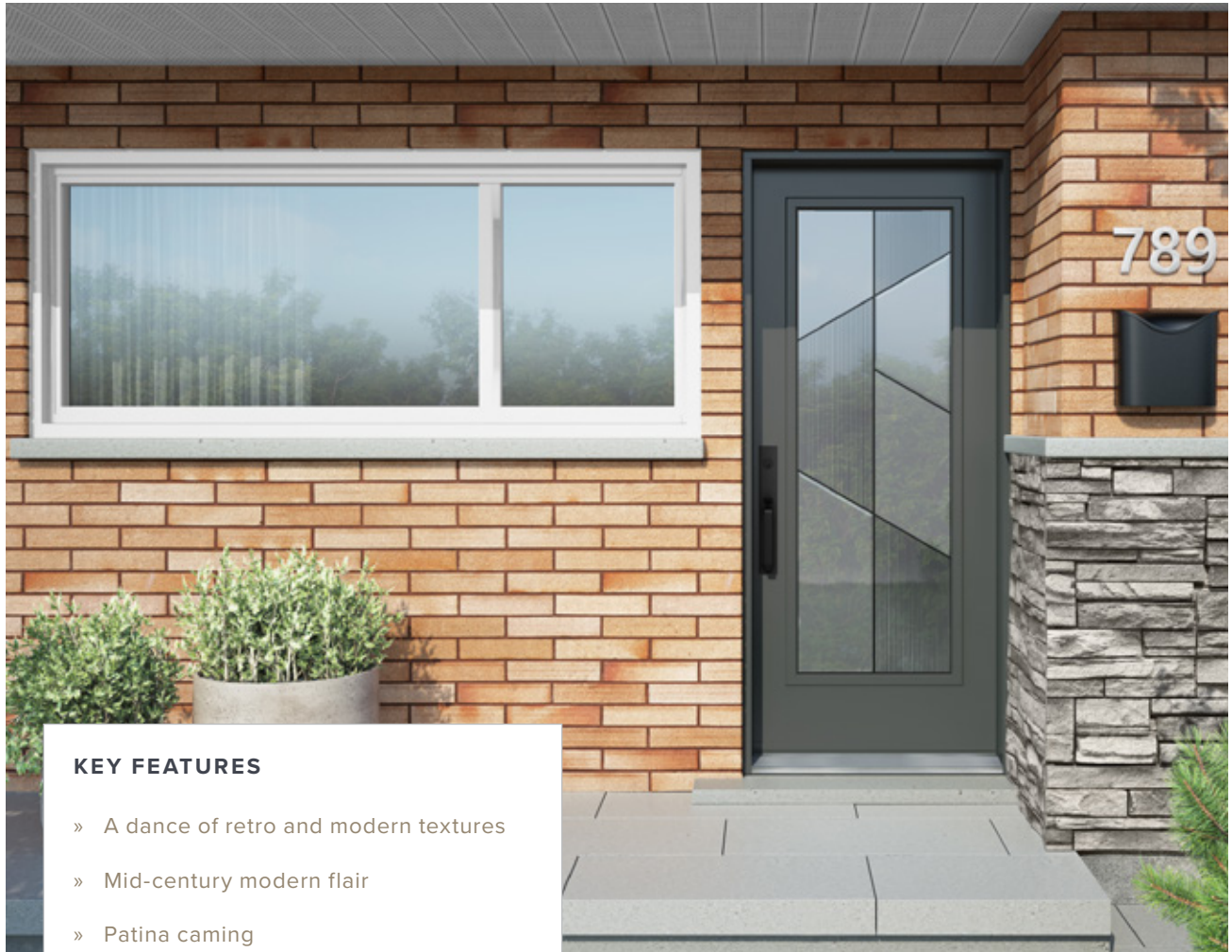

## KEY FEATURES

- » A dance of retro and modern textures
- » Mid-century modern flair
- » Patina caming

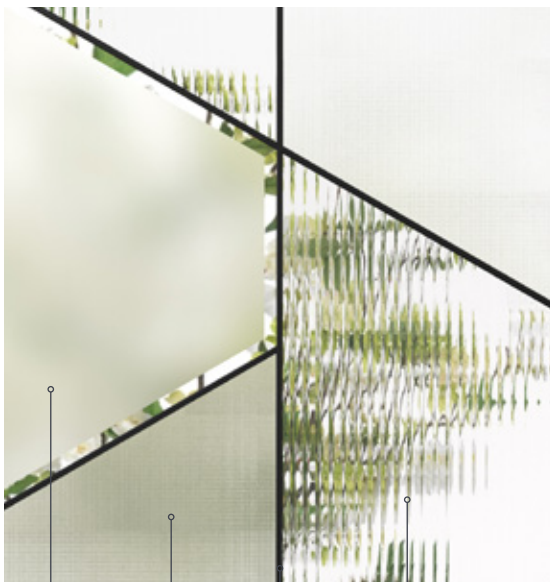

beveled satin finish glass    screen glass    patina caming    wide reed glass

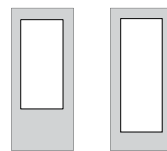

## PRIVACY RATING

\$\$\$\$

1 2 3 4 5 **6** 7 8 9 10

least obscure

most obscure

Explore all available styles on page **104**

# CACHET

CACHET 404 3/4 lite in a steel slab



## KEY FEATURES

- » Inspired by prairie style architecture
- » Zinc or Patina coming
- » Balanced and chic

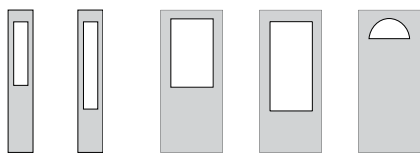

\$\$\$

## PRIVACY RATING



krinkle textured glass

chord textured glass

pinhead textured glass

zinc coming

clear beveled glass

Explore all available styles on page **104**

CELESTE 404 3/4 lite in a steel slab with 450 3/4 sidelite



### KEY FEATURES

- » Delicate geometric pattern
- » Refined and balanced light effect
- » Patina coming



clear  
beveled  
glass

small  
hammered  
glass

aqualite  
glass

platinum  
coming

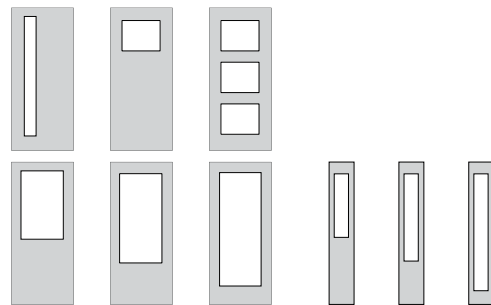

### PRIVACY RATING

\$\$\$\$

1 2 3 4 5 6 **7** 8 9 10

least obscure

most obscure

Explore all available styles on page **104**

# CHANELLE

CHANELLE 404 3/4 lites in smooth fibreglass slabs

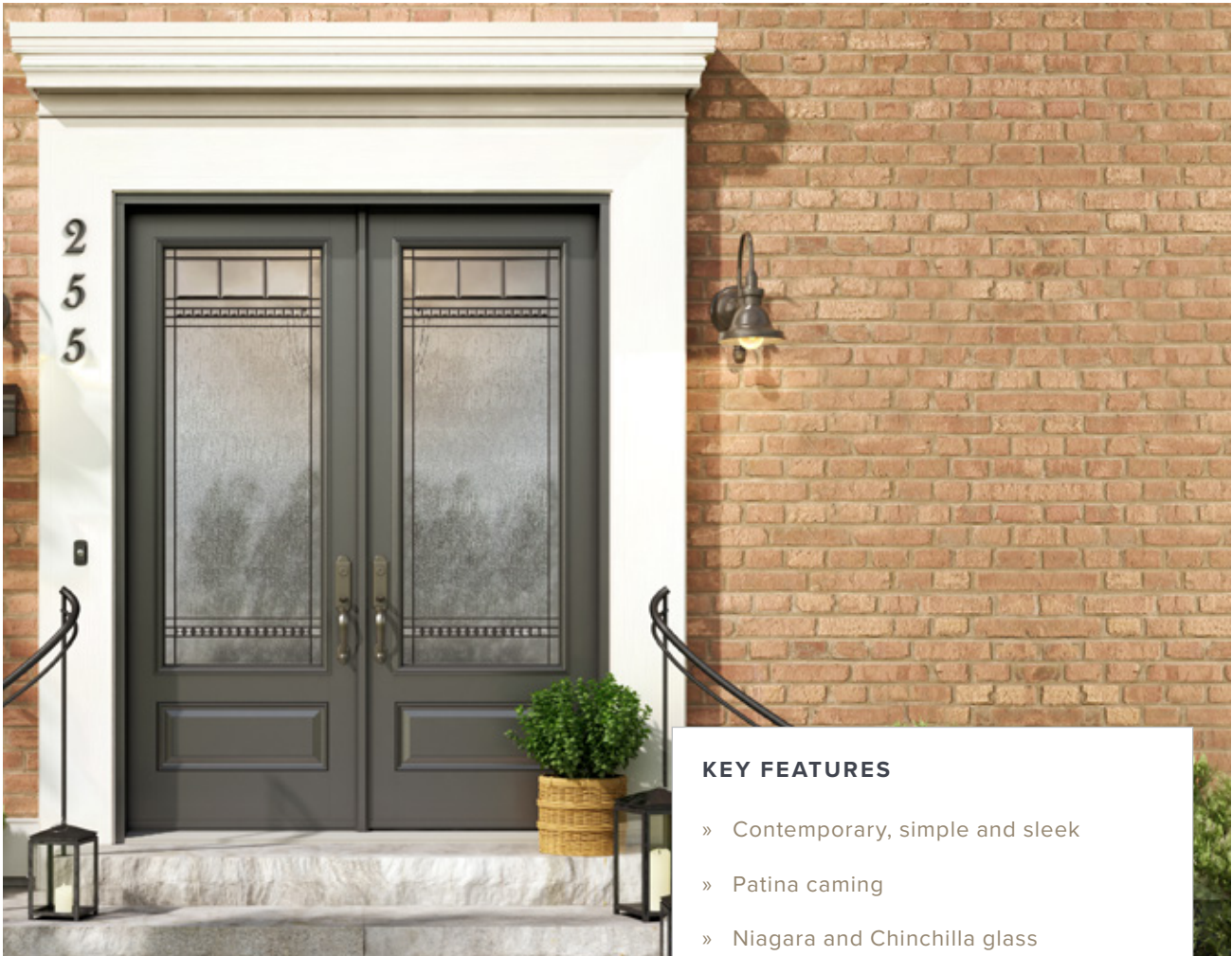

## KEY FEATURES

- » Contemporary, simple and sleek
- » Patina caming
- » Niagara and Chinchilla glass

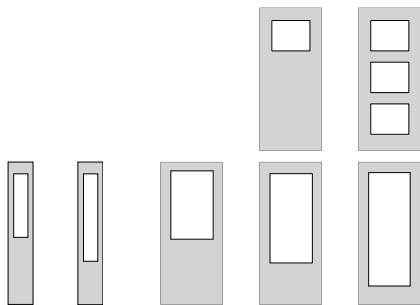

\$\$\$\$

## PRIVACY RATING



niagara  
textured  
glass

clear  
beveled  
glass

patina  
caming

chinchilla  
textured  
glass

Explore all available styles on page **104**

CHELSEA® 404 3/4 lite in a smooth fiberglass slab with a 450 3/4 sidelite

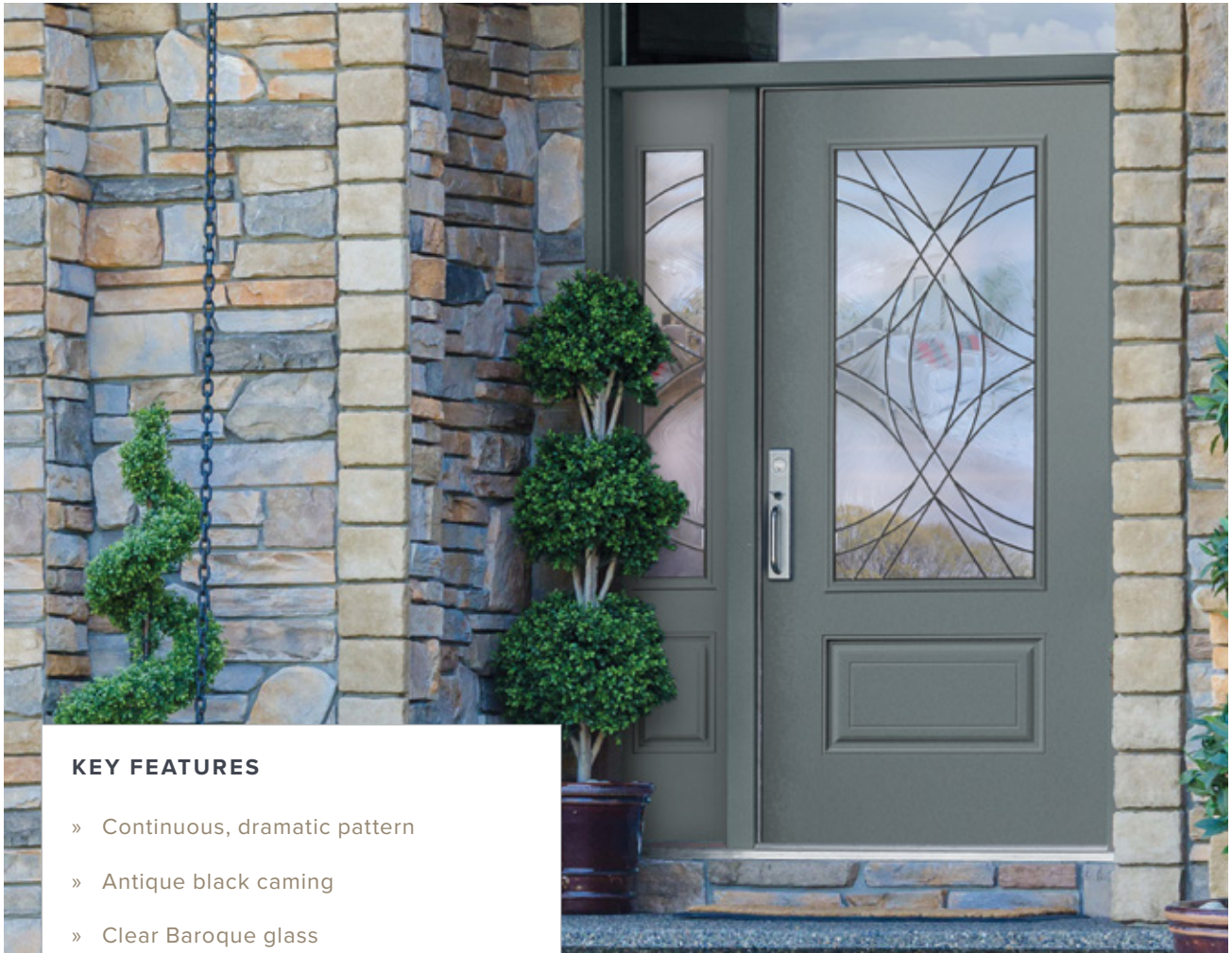

**KEY FEATURES**

- » Continuous, dramatic pattern
- » Antique black caming
- » Clear Baroque glass



clear  
beveled  
glass

antique  
black  
caming

clear  
baroque  
glass

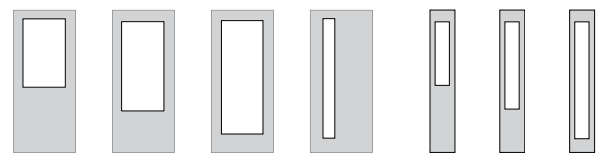

**PRIVACY RATING**

\$\$\$\$

1 2 3 4 5 6 7 8 9 10

least obscure

most obscure

Explore all available styles on page 106

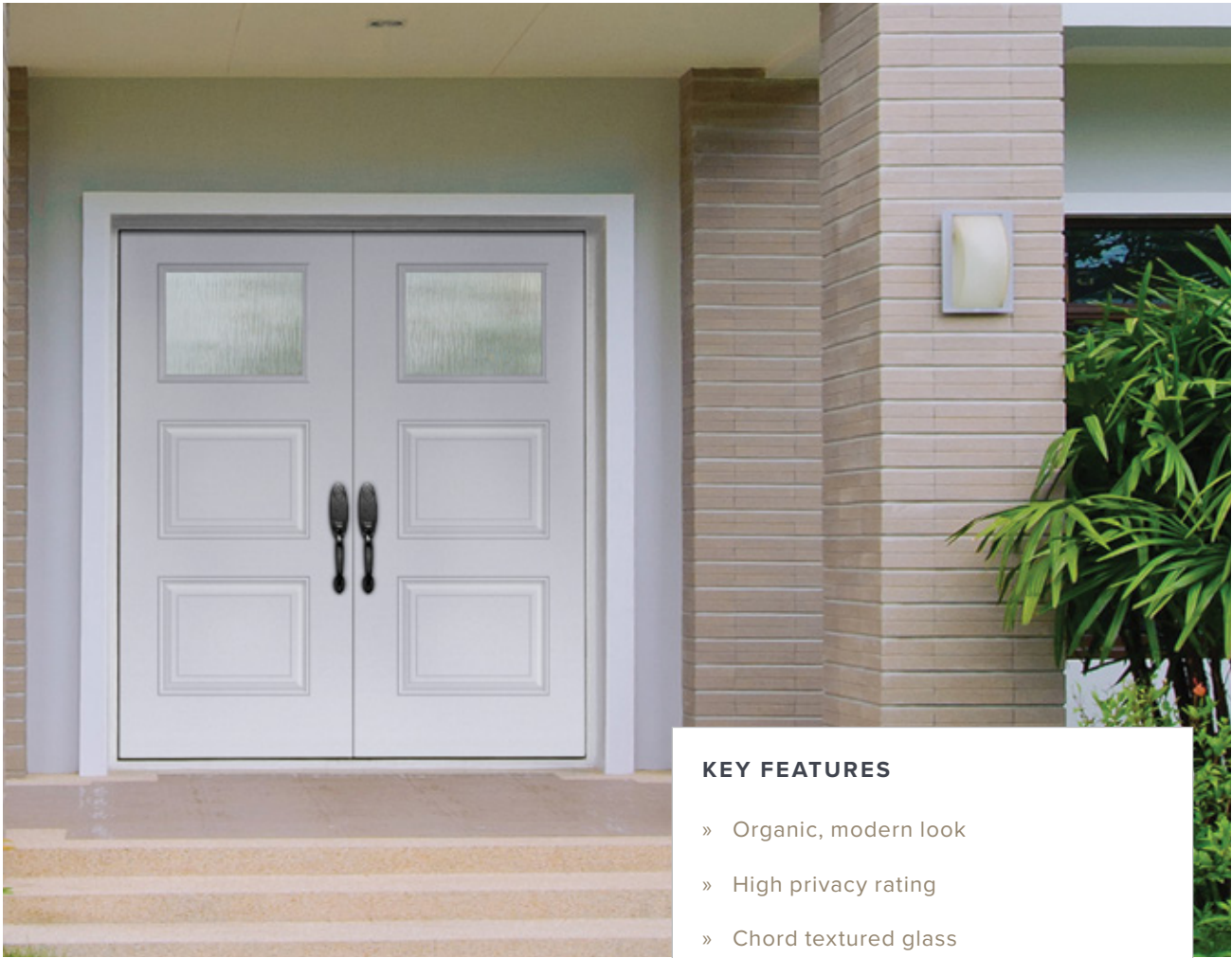

### KEY FEATURES

- » Organic, modern look
- » High privacy rating
- » Chord textured glass

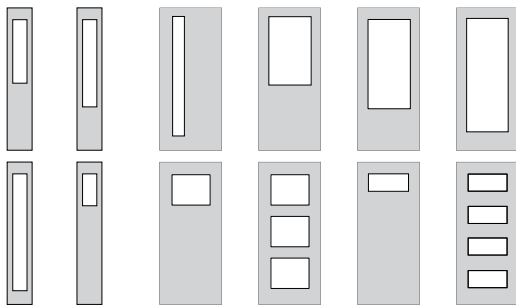

\$\$

PRIVACY RATING

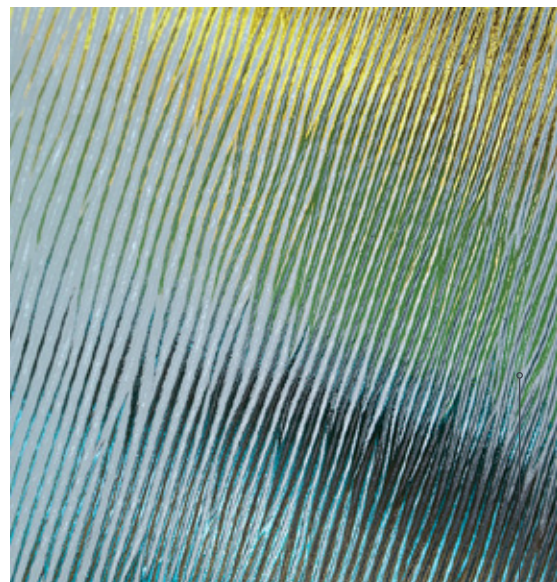

chord  
textured  
glass

Explore all available styles on page **106**

CROSSWALK 122 full lite in a smooth fibreglass slab with a 152 full sidelite



## KEY FEATURES

- » Abstract, modern, and stylish
- » Nickel caming
- » Pops of grey software glass



micro-iced granite glass

clear software glass

nickel caming

grey software glass

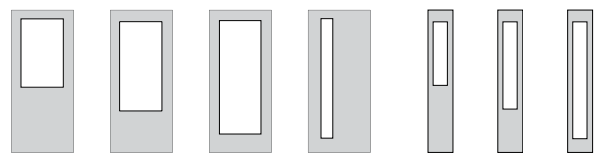

## PRIVACY RATING

\$\$

1 2 3 4 5 6 7 8 9 10

least obscure

most obscure

Explore all available styles on page 106

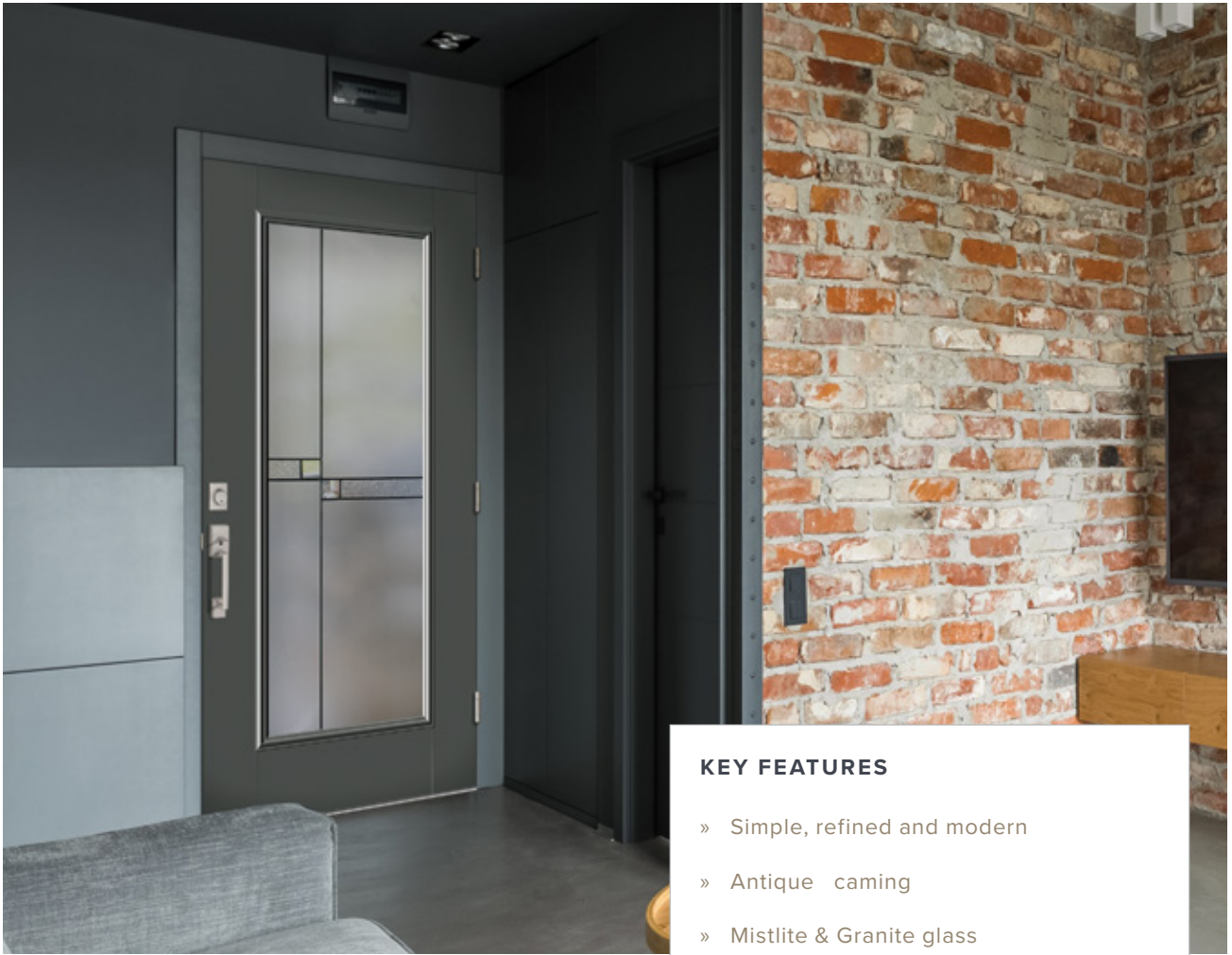

**KEY FEATURES**

- » Simple, refined and modern
- » Antique caming
- » Mistlite & Granite glass

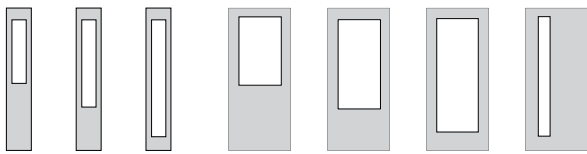

\$\$\$

**PRIVACY RATING**

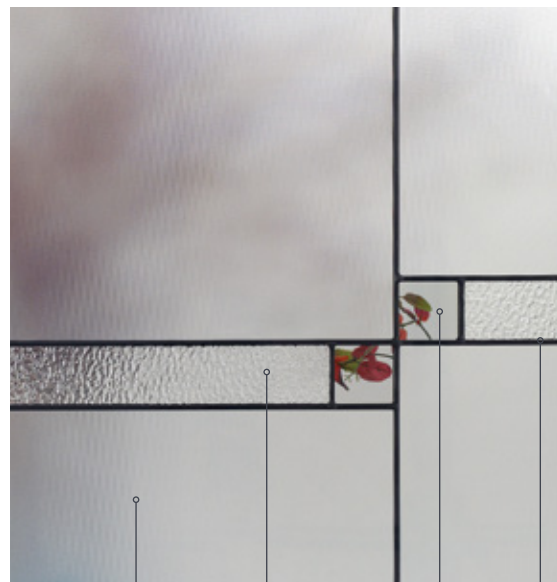

mistlite glass granite glass clear glass antique black caming

Explore all available styles on page **106**



CUZCO® 122 full lite in a smooth fibreglass slab with 152 full sidelites

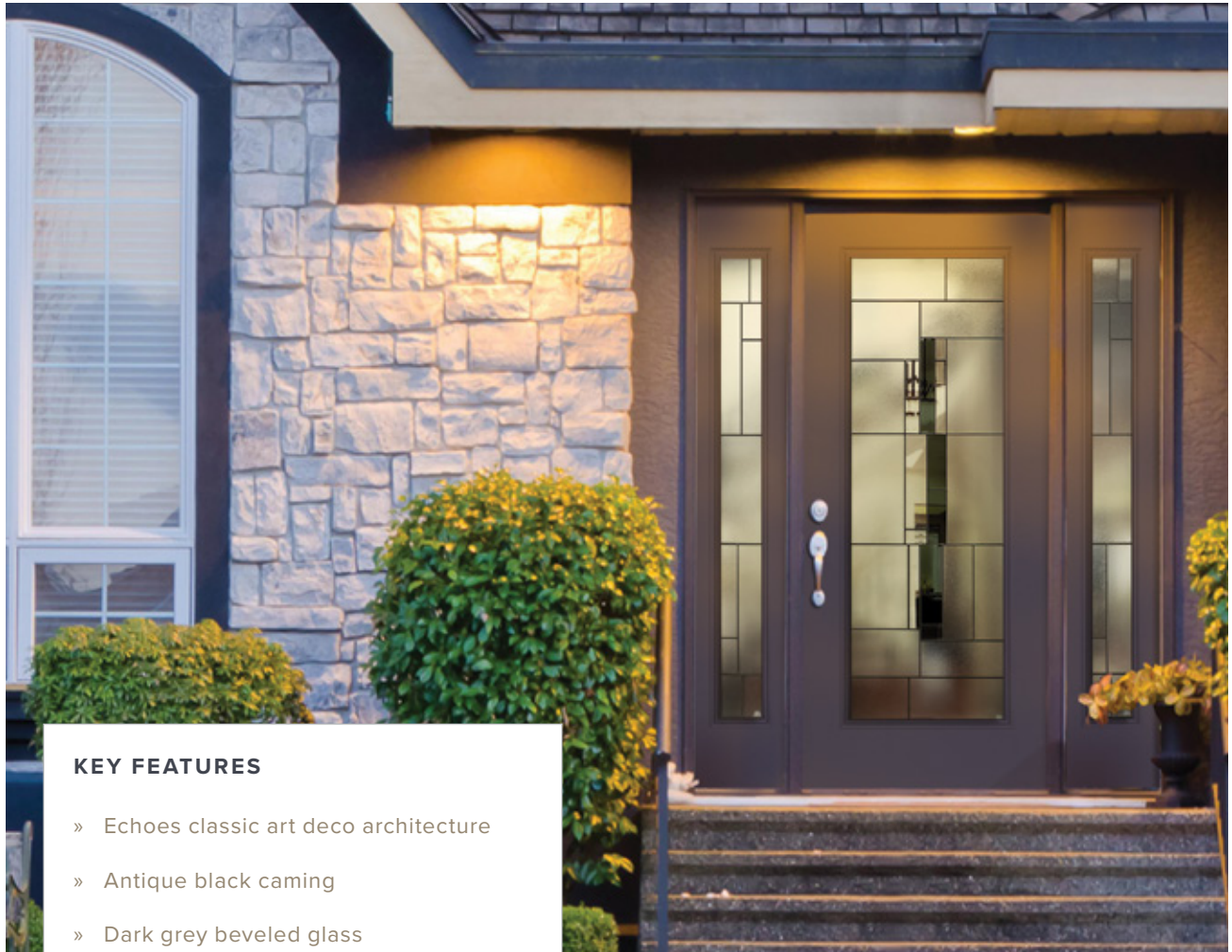

**KEY FEATURES**

- » Echoes classic art deco architecture
- » Antique black caming
- » Dark grey beveled glass



- mistlite glass
- antique black caming
- seedy glass
- clear beveled glass
- dark grey beveled glass
- pear glass
- dark grey glass

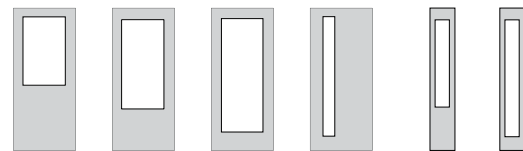

**PRIVACY RATING**

\$\$\$



Explore all available styles on page 106



### KEY FEATURES

- » Contemporary and elegant look
- » Antique black & platinum caming
- » Granite textured glass

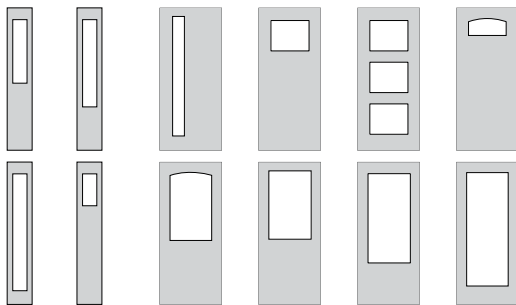

\$\$

### PRIVACY RATING



antique black caming

granite textured glass

granite beveled glass

clear beveled glass

Explore all available styles on page **106**

ENTROPY 122 full lites in smooth fibreglass slabs

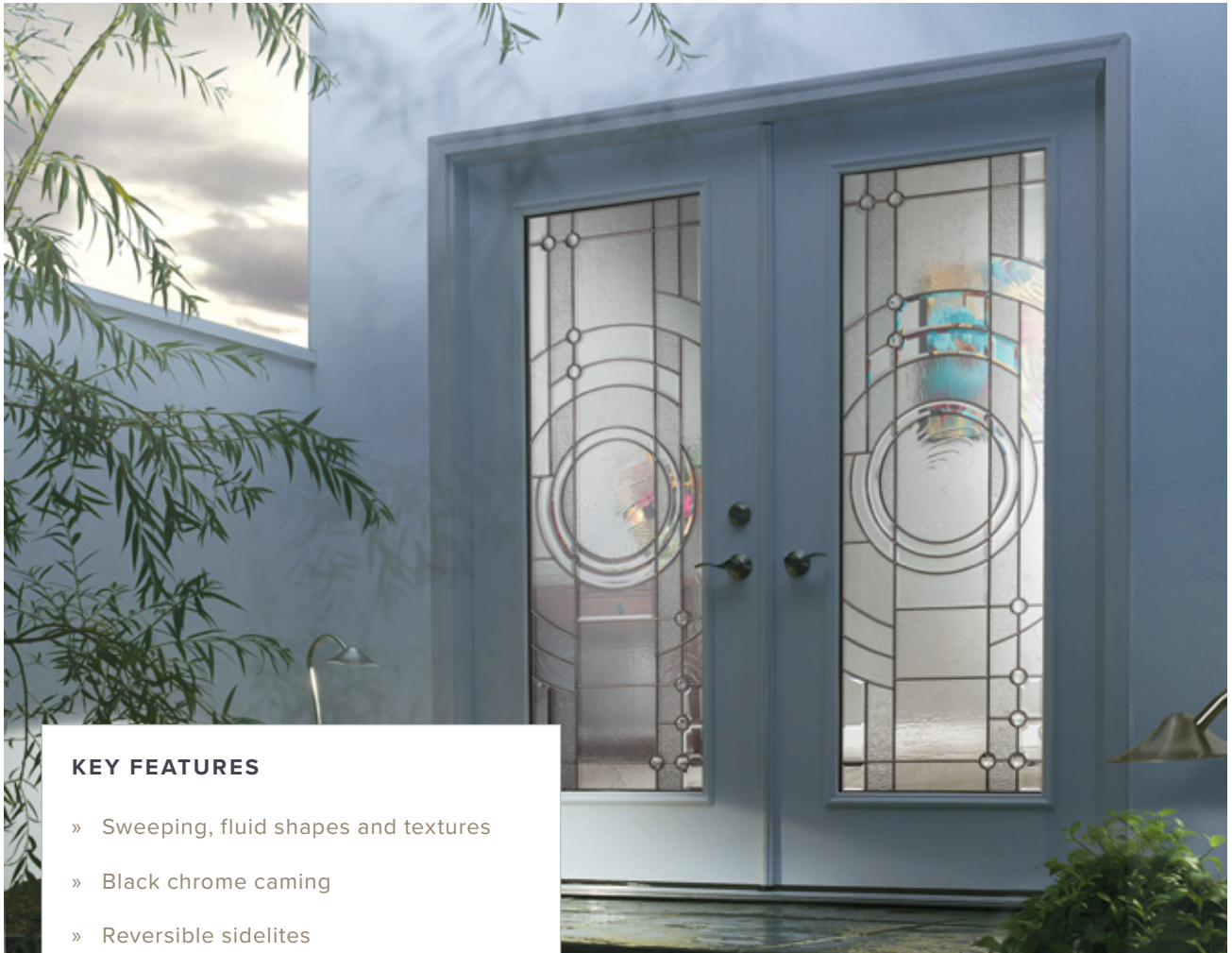

## KEY FEATURES

- » Sweeping, fluid shapes and textures
- » Black chrome caming
- » Reversible sidelites



seedy textured glass granite textured glass clear renaissance glass clear beveled glass black chrome caming

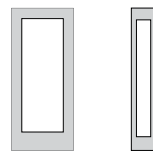

## PRIVACY RATING

\$\$\$\$

1 2 3 4 5 6 7 8 9 10

least obscure

most obscure

Explore all available styles on page 106

# EQUATION

**EQUATION** 122 full lites in smooth fibreglass slabs

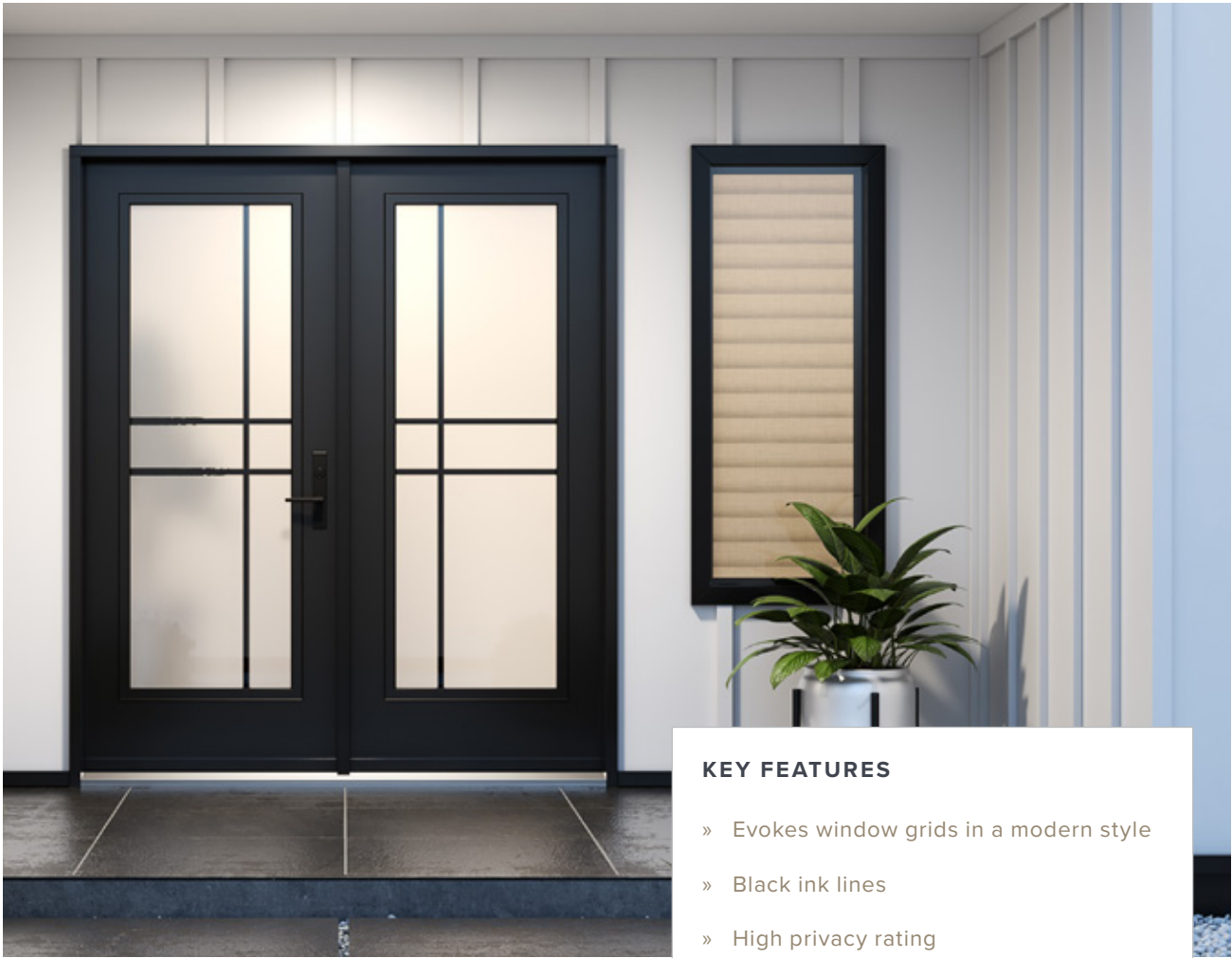

## KEY FEATURES

- » Evokes window grids in a modern style
- » Black ink lines
- » High privacy rating

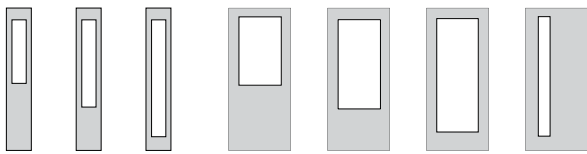

\$\$

**PRIVACY RATING**



sandblasted  
glass

clear  
glass  
lines

black  
ink  
lines

Explore all available styles on page **106**

FLUID 122 full lite in a smooth fibreglass slab

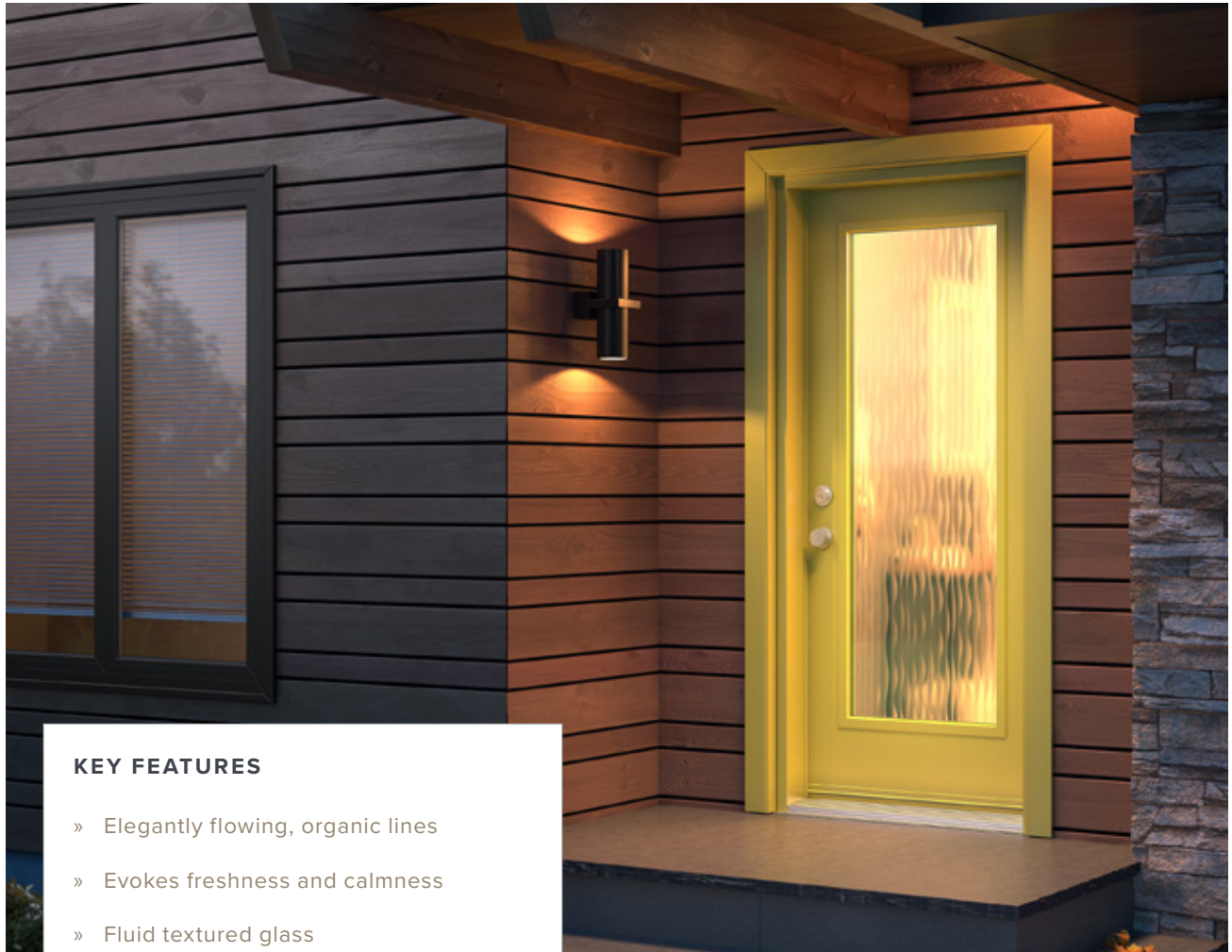

## KEY FEATURES

- » Elegantly flowing, organic lines
- » Evokes freshness and calmness
- » Fluid textured glass



fluid glass

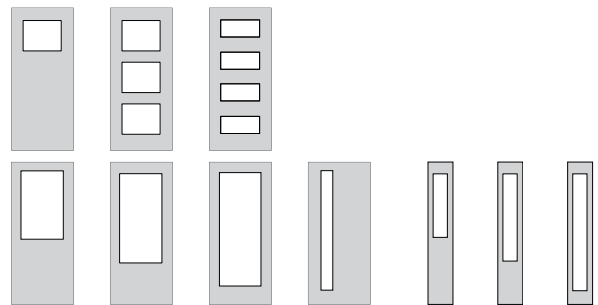

## PRIVACY RATING

\$\$\$\$



Explore all available styles on page 108

# FOCUS

FOCUS 217 lite in a smooth fibreglass slab with a clear transom

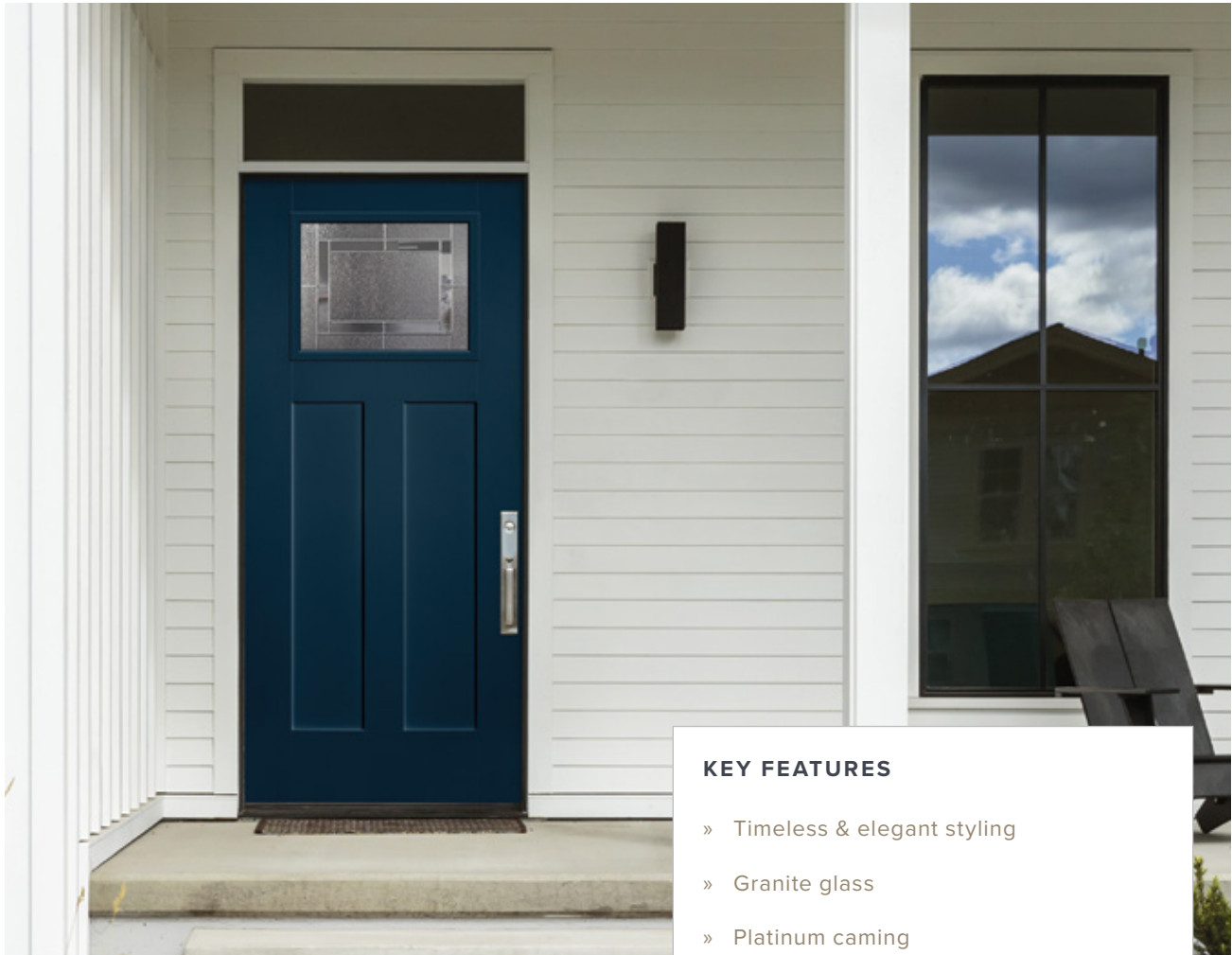

## KEY FEATURES

- » Timeless & elegant styling
- » Granite glass
- » Platinum caming

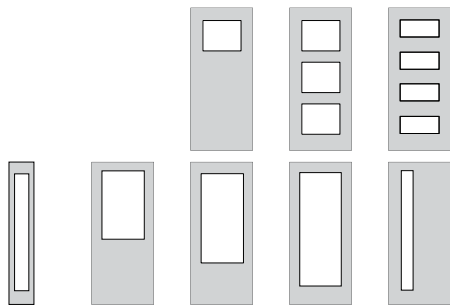

\$\$\$

## PRIVACY RATING



clear  
glass

granite  
glass

platinum  
caming

Explore all available styles on page **108**

FRONTIER® 404 3/4 lite in a smooth fibreglass slab with clear glass sidelites and transom

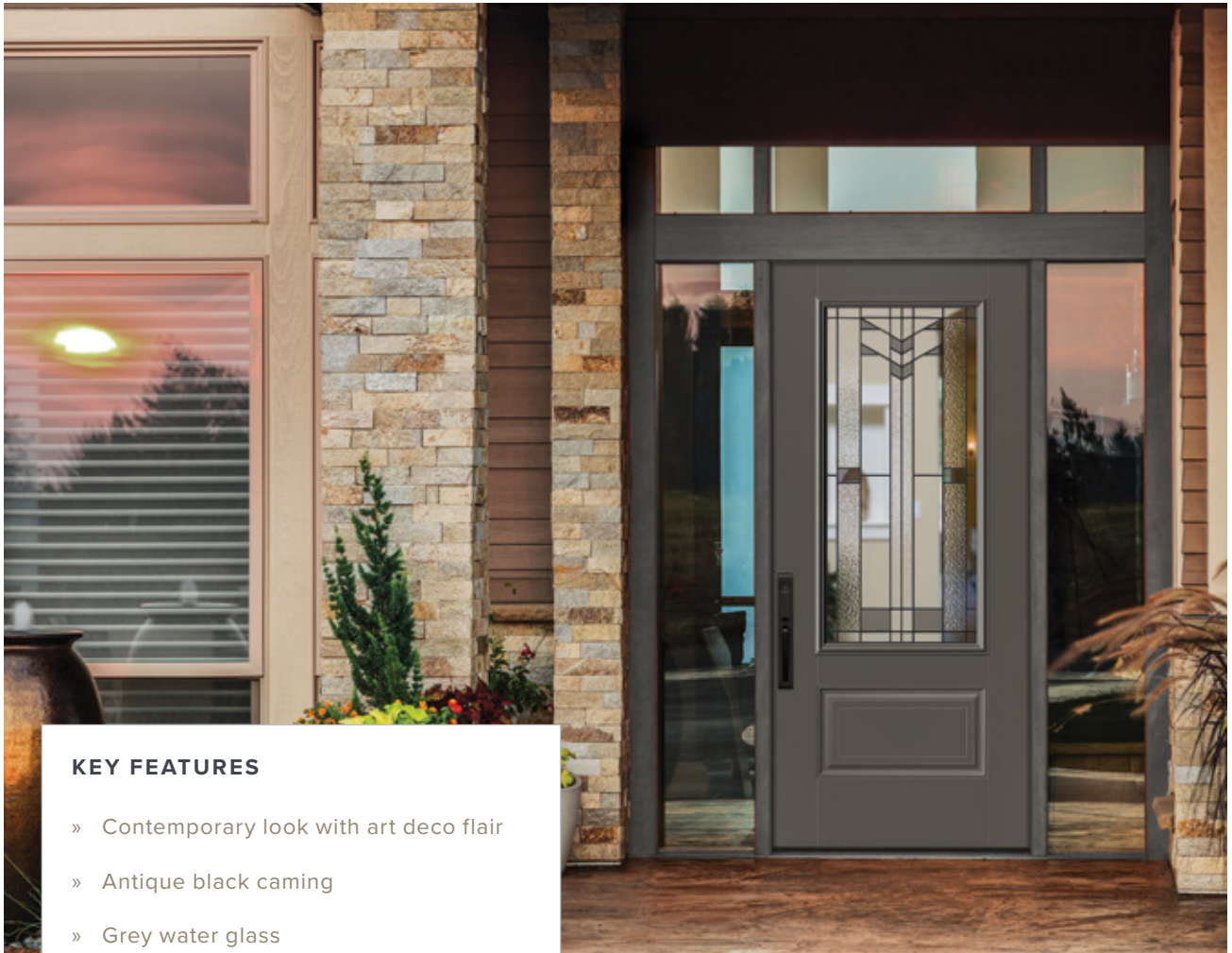

**KEY FEATURES**

- » Contemporary look with art deco flair
- » Antique black caming
- » Grey water glass



pear textured glass

antique black caming

grey water glass

seedy textured glass

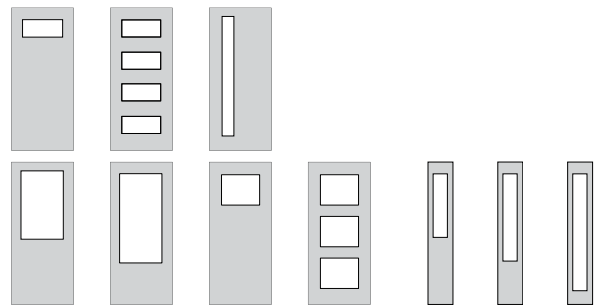

**PRIVACY RATING**

\$\$\$

1 2 3 4 5 6 7 8 9 10

least obscure

most obscure

Explore all available styles on page 108

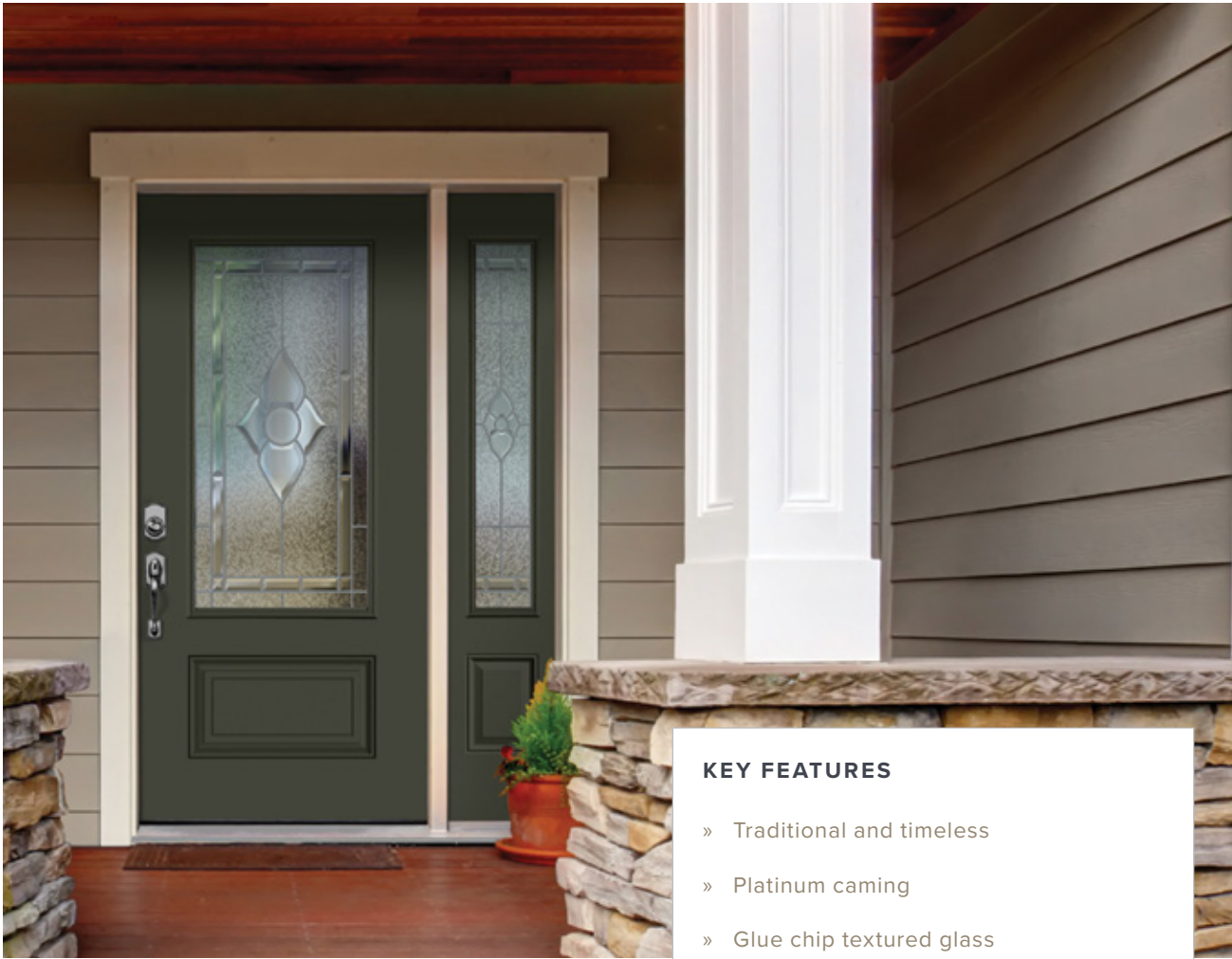

### KEY FEATURES

- » Traditional and timeless
- » Platinum caming
- » Glue chip textured glass

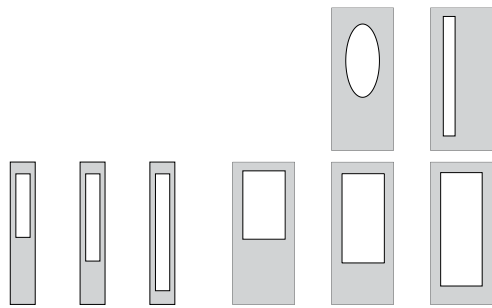

\$\$

PRIVACY RATING



clear  
beveled  
glass

glue chip  
textured  
glass

platinum  
caming

Explore all available styles on page **108**



HARLOW 404 3/4 lite in a steel slab



## KEY FEATURES

- » High privacy rating
- » Patina coming
- » Narrow reed textured glass



granite textured glass   patina coming   narrow reed glass   sandblast textured glass   clear beveled glass

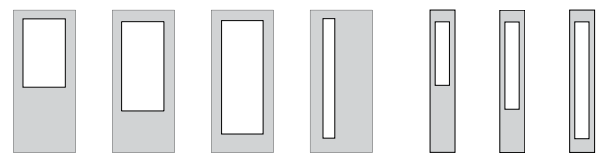

## PRIVACY RATING

\$\$\$

1 2 3 4 5 6 7 8 9 10

least obscure

most obscure

Explore all available styles on page **108**

# HOLLISTER

HOLLISTER 122 full lite in a smooth fibreglass slab

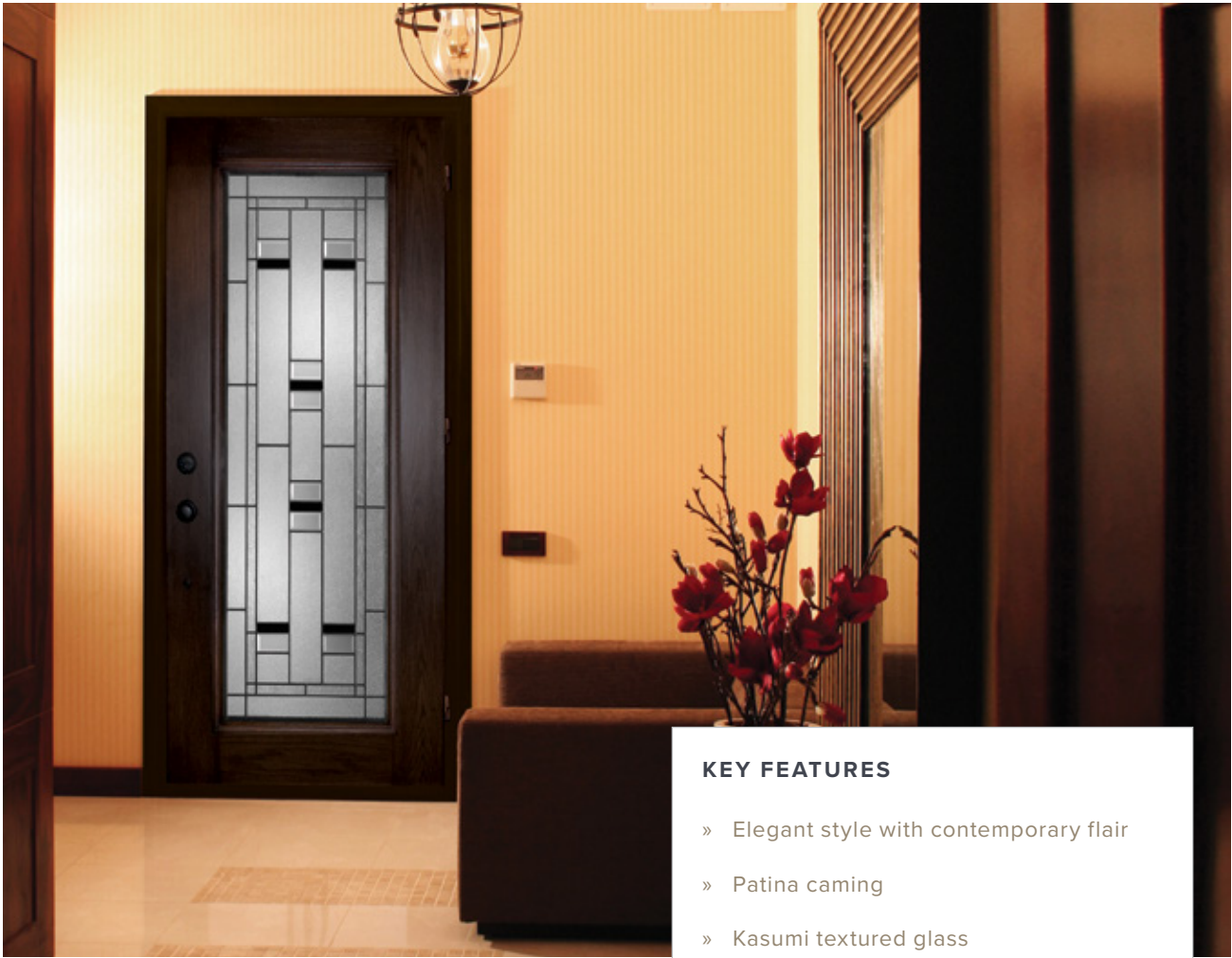

## KEY FEATURES

- » Elegant style with contemporary flair
- » Patina coming
- » Kasumi textured glass

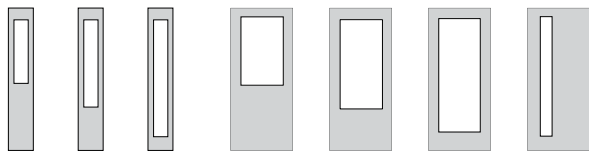

\$\$

PRIVACY RATING



rain textured glass    black glass    kasumi textured glass    patina coming    clear beveled glass

Explore all available styles on page **108**

KORDELLA® 122 full lites in smooth fibreglass slabs

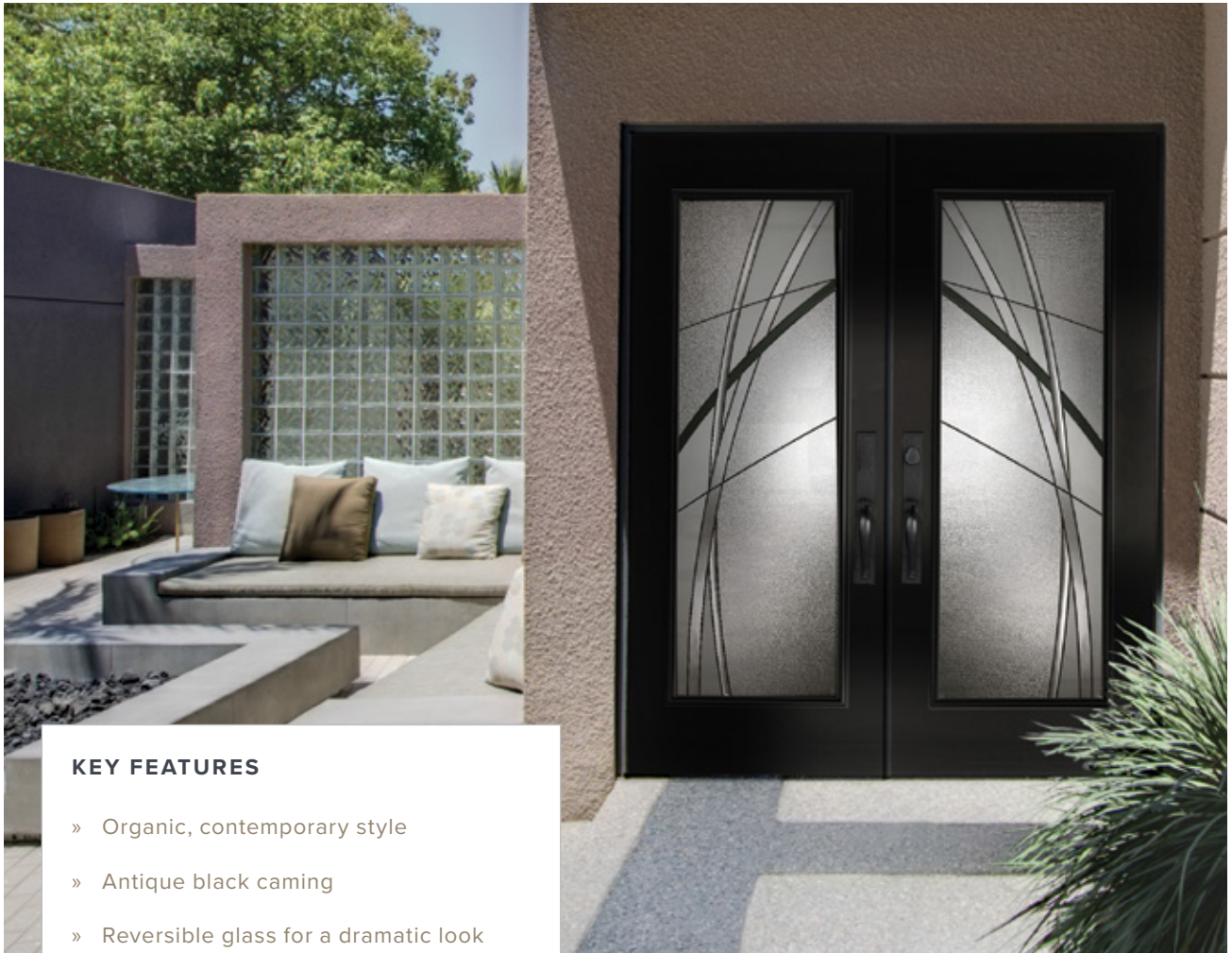

**KEY FEATURES**

- » Organic, contemporary style
- » Antique black caming
- » Reversible glass for a dramatic look

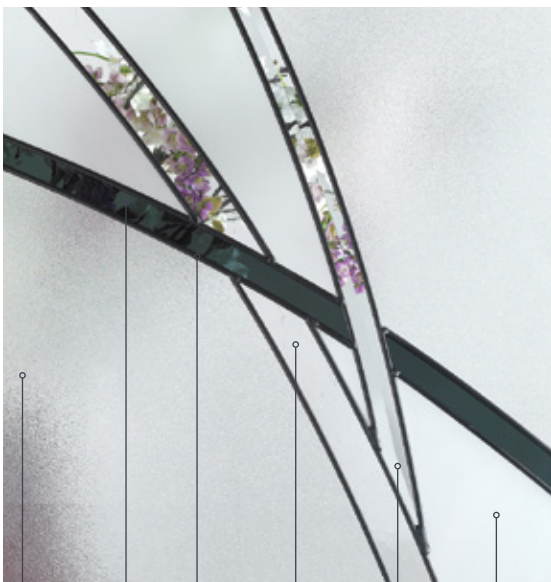

pear textured glass    dark grey glass    antique black caming    seedy textured glass    clear beveled glass    white etched glass

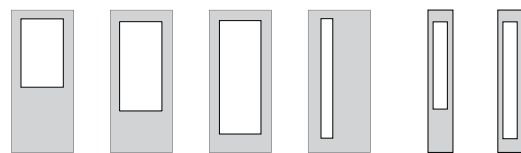

**PRIVACY RATING**

\$\$\$

1 2 3 4 5 6 7 **8** 9 10

least obscure

most obscure

Explore all available styles on page 108

# LEXINGTON

LEXINGTON  
106 1/2 lites in steel slabs



## KEY FEATURES

- » Classic inspiration, contemporary flair
- » Patina and zinc caming
- » Drawn and grey ripple textured glass

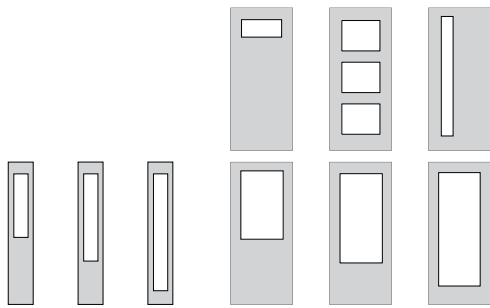

\$\$\$\$

## PRIVACY RATING



patina  
caming

clear  
beveled  
glass

drawn  
textured  
glass

grey  
ripple  
glass

clear  
ripple  
glass

Explore all available styles on page **108**

LOUISBOURG 404 3/4 lite in a steel slab



**KEY FEATURES**

- » Reminiscent of engraved glass art
- » Structured, geometric and elegant
- » Sandblasted & grey ink

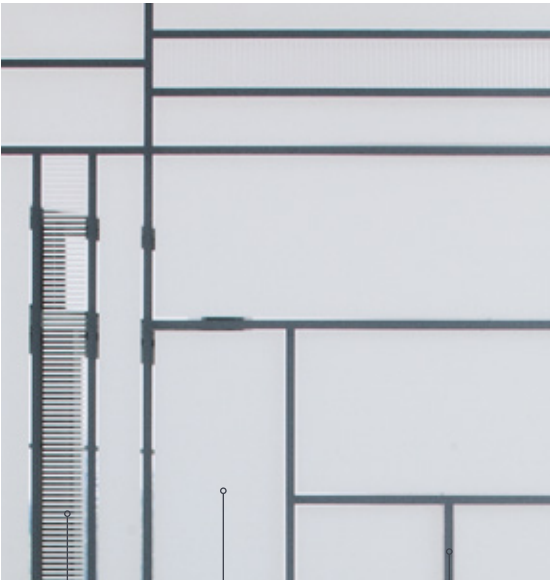

clear glass slits  
sandblasted ink finish  
grey ink

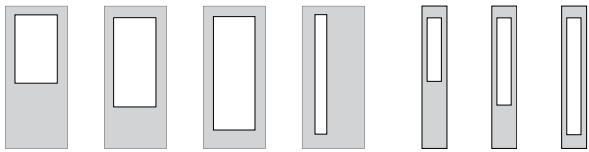

**PRIVACY RATING**      \$\$



Explore all available styles on page **110**



**KEY FEATURES**

- » Sleek and traditionally artistic
- » Antique black caming
- » Grey and clear water glass

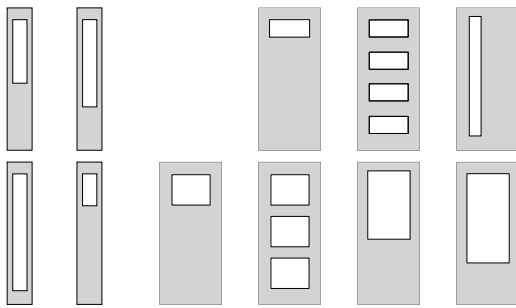

\$\$\$

**PRIVACY RATING**



antique black caming    seedy textured glass    grey water glass    granite textured glass    clear water glass

Explore all available styles on page **110**

# MID-CENTURY MODERN

SATIN ETCH 6 x 223 lites in a steel slab with full glass clear sidelite

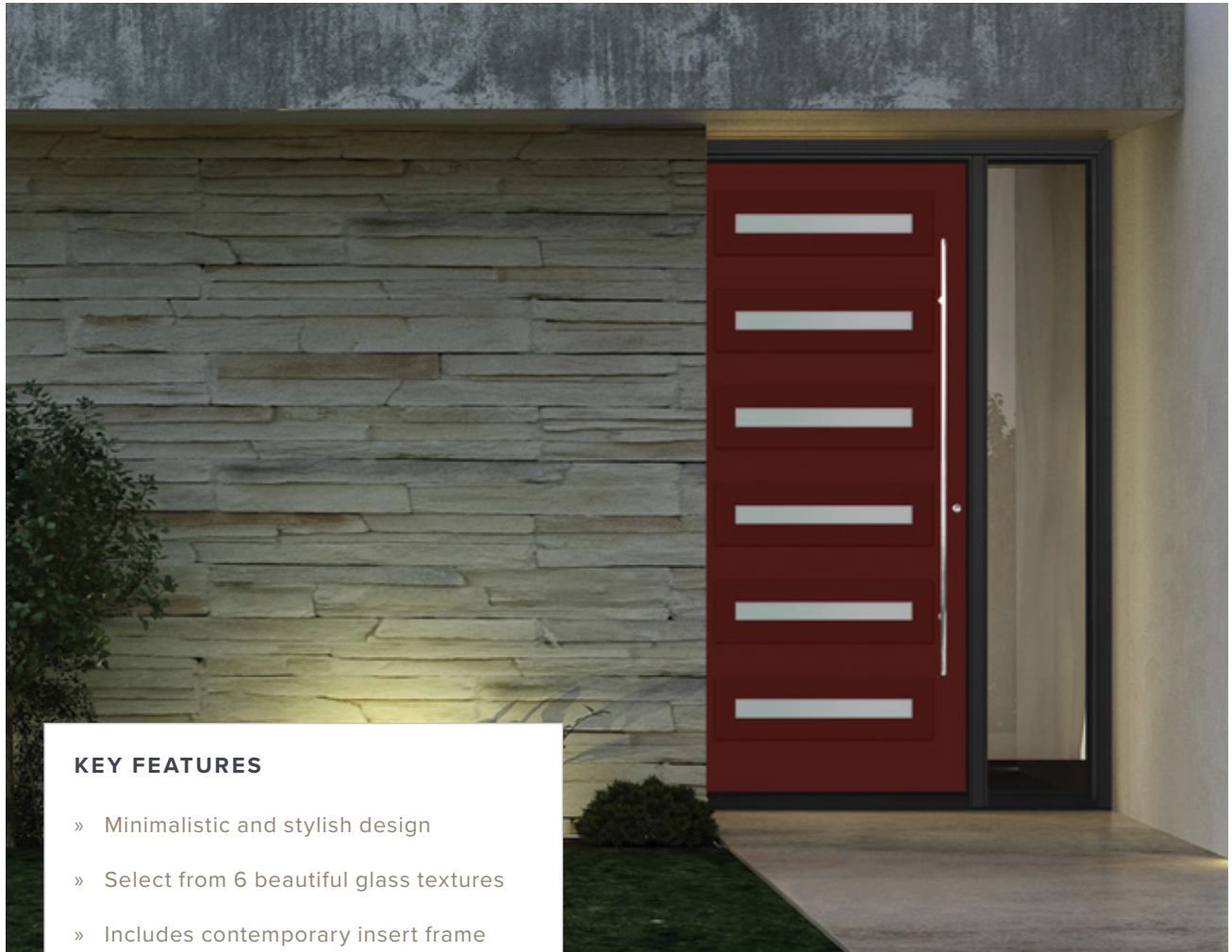

## KEY FEATURES

- » Minimalistic and stylish design
- » Select from 6 beautiful glass textures
- » Includes contemporary insert frame

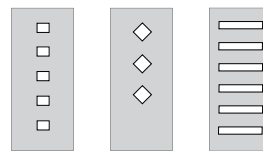
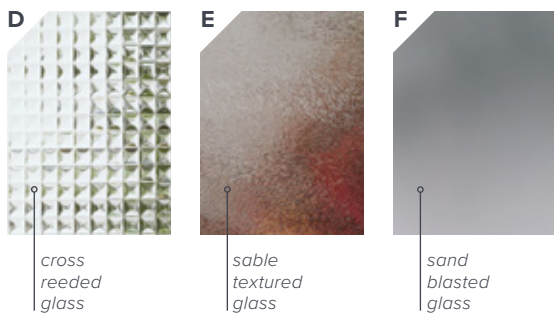
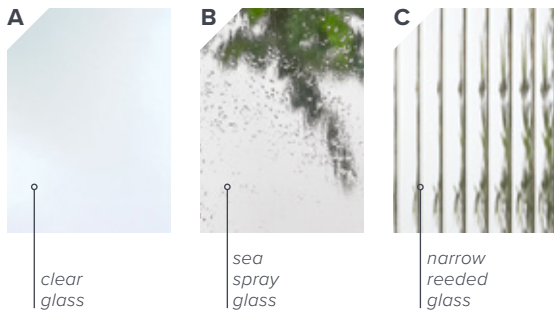

## PRIVACY RATINGS

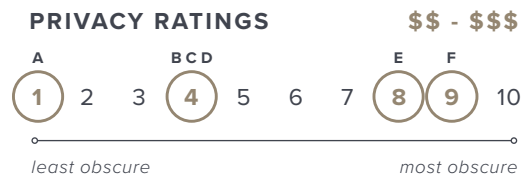

Explore all available styles on page **116**

# MISTIFY

MISTIFY 403 3/4 lite in a smooth fibreglass slab



## KEY FEATURES

- » A striking fusion of pattern and texture
- » Modern, organic design
- » Black ceramic frit

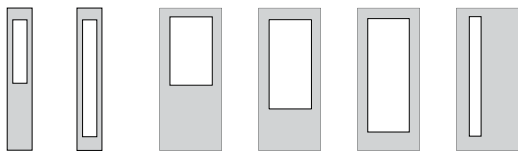

\$\$

PRIVACY RATING



soft  
textured  
glass

black  
ceramic  
frit

Explore all available styles on page **110**



MINSTRAL 122 full lite in a smooth fibreglass slab with 152 full sidelites and rain glass transom

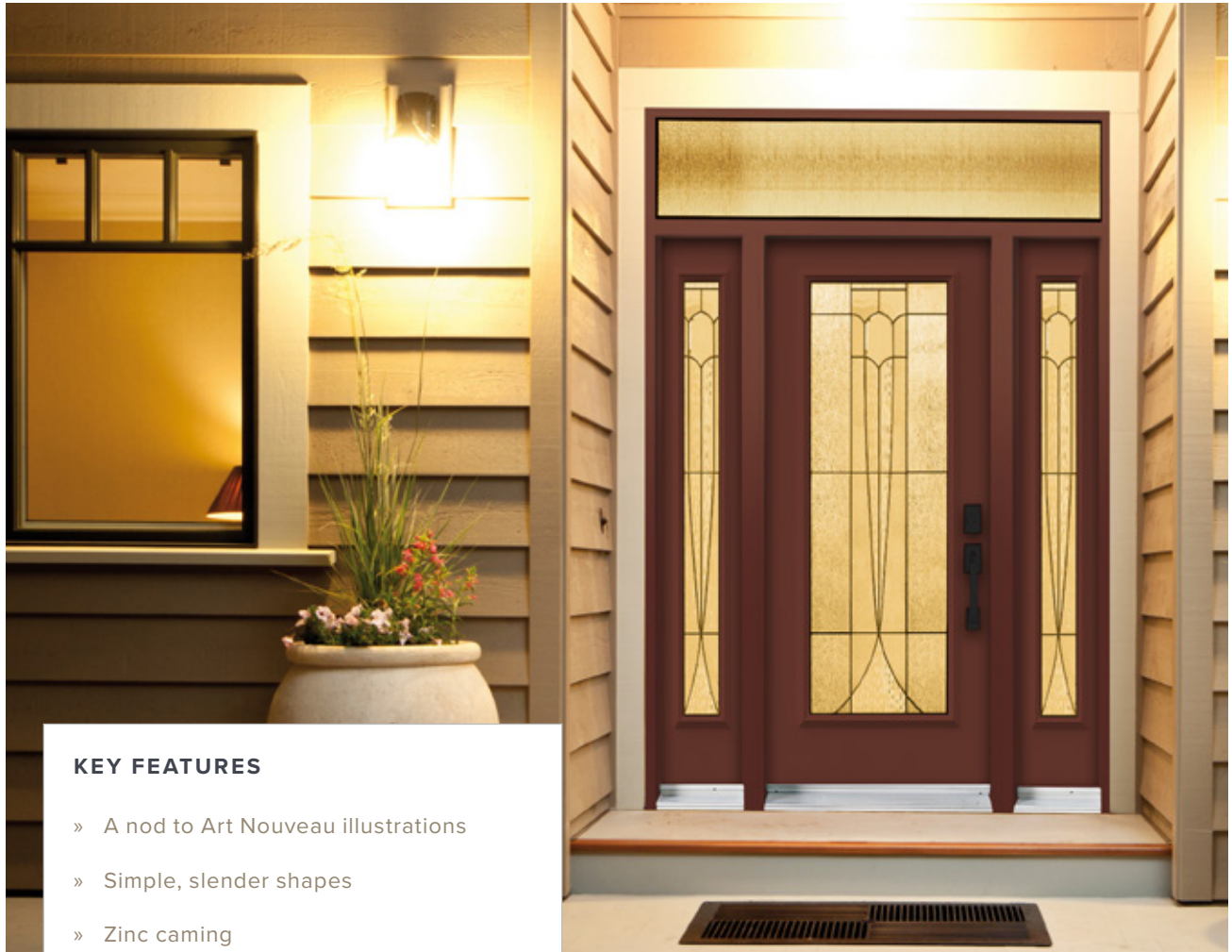

## KEY FEATURES

- » A nod to Art Nouveau illustrations
- » Simple, slender shapes
- » Zinc caming



niagara glass

small-hammered glass

sydney glass

bevelled pinhead glass

zinc caming

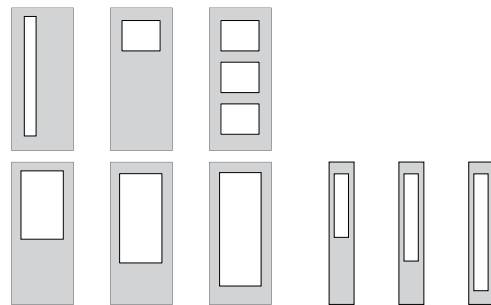

## PRIVACY RATING

\$\$\$\$

1 2 3 4 5 6 **7** 8 9 10

least obscure

most obscure

Explore all available styles on page **110**

# MODENA

MODENA 122 full lite in a steel slab

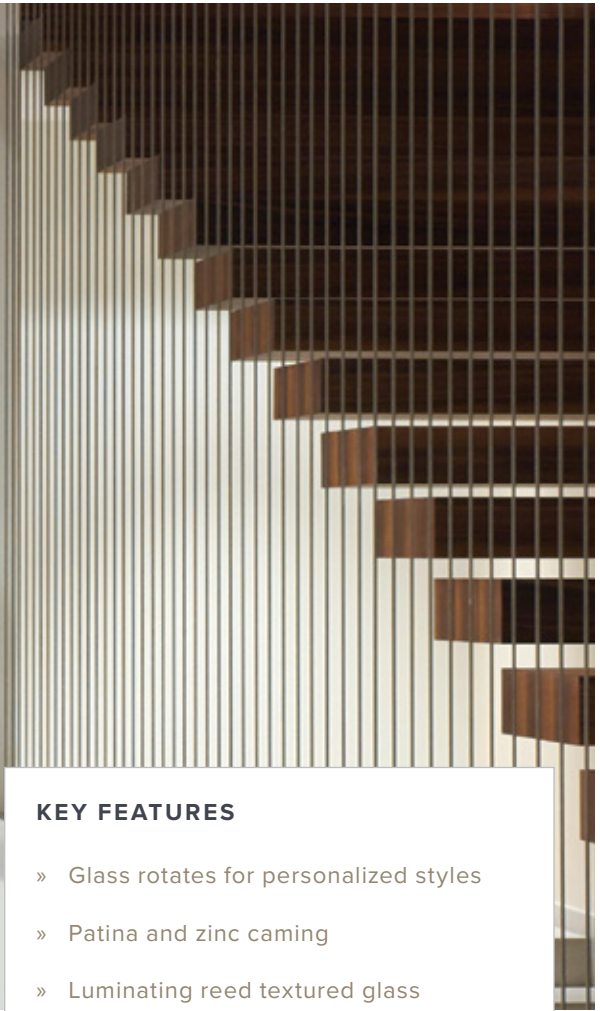

### KEY FEATURES

- » Glass rotates for personalized styles
- » Patina and zinc caming
- » Luminating reed textured glass

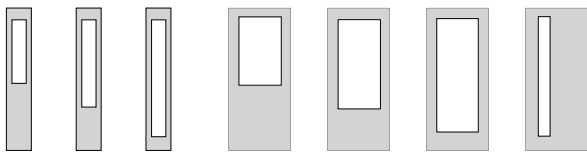

\$\$\$

### PRIVACY RATING

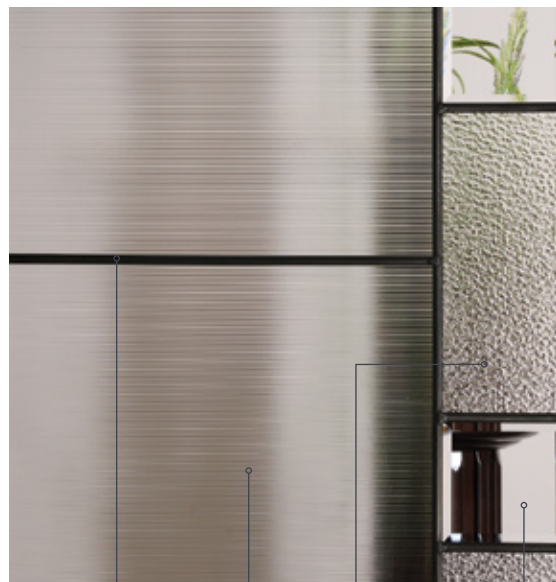

patina  
caming

luminating  
reed  
glass

granite  
textured  
glass

clear  
beveled  
glass

Explore all available styles on page **110**

MONTEREY 122 full lite in an oak textured fiberglass slab



### KEY FEATURES

- » Craftsman design with modern flair
- » Patina and satin nickel caming
- » Granite and clear beveled glass

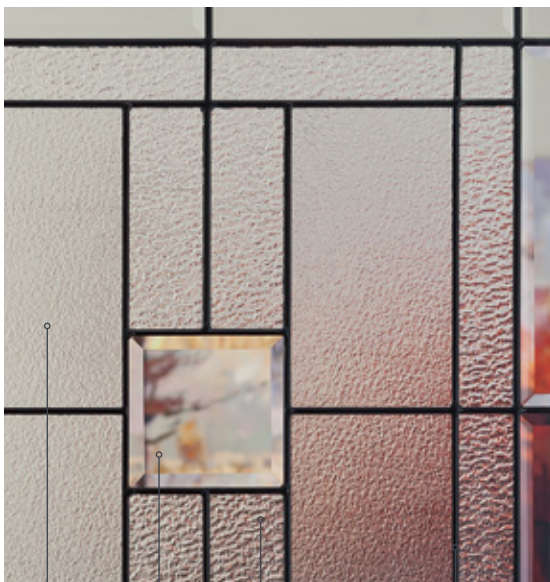

micro  
granite  
glass

clear  
beveled  
glass

granite  
textured  
glass

patina  
caming

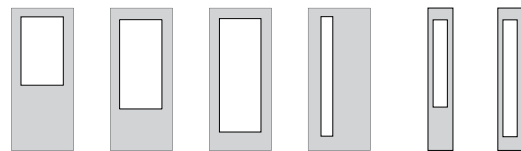

PRIVACY RATING

\$\$

1 2 3 4 5 6 7 8 9 10

least obscure

most obscure

Explore all available styles on page **110**



### KEY FEATURES

- » Ultimate in contemporary elegance
- » Antique black caming
- » Granite and narrow reed glass

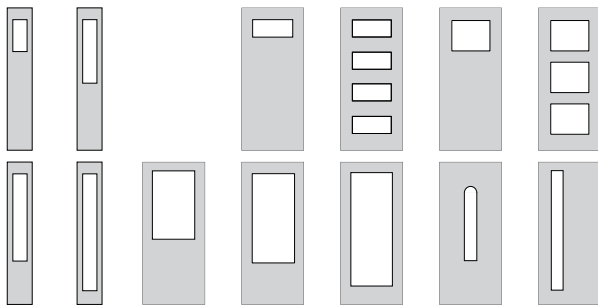

\$\$\$

### PRIVACY RATING



antique  
black  
caming

clear  
beveled  
glass

narrow  
reed  
glass

granite  
textured  
glass

Explore all available styles on page **110**

NUANDO 122 full lite in a smooth fiberglass slab with opaque sidelite and transom

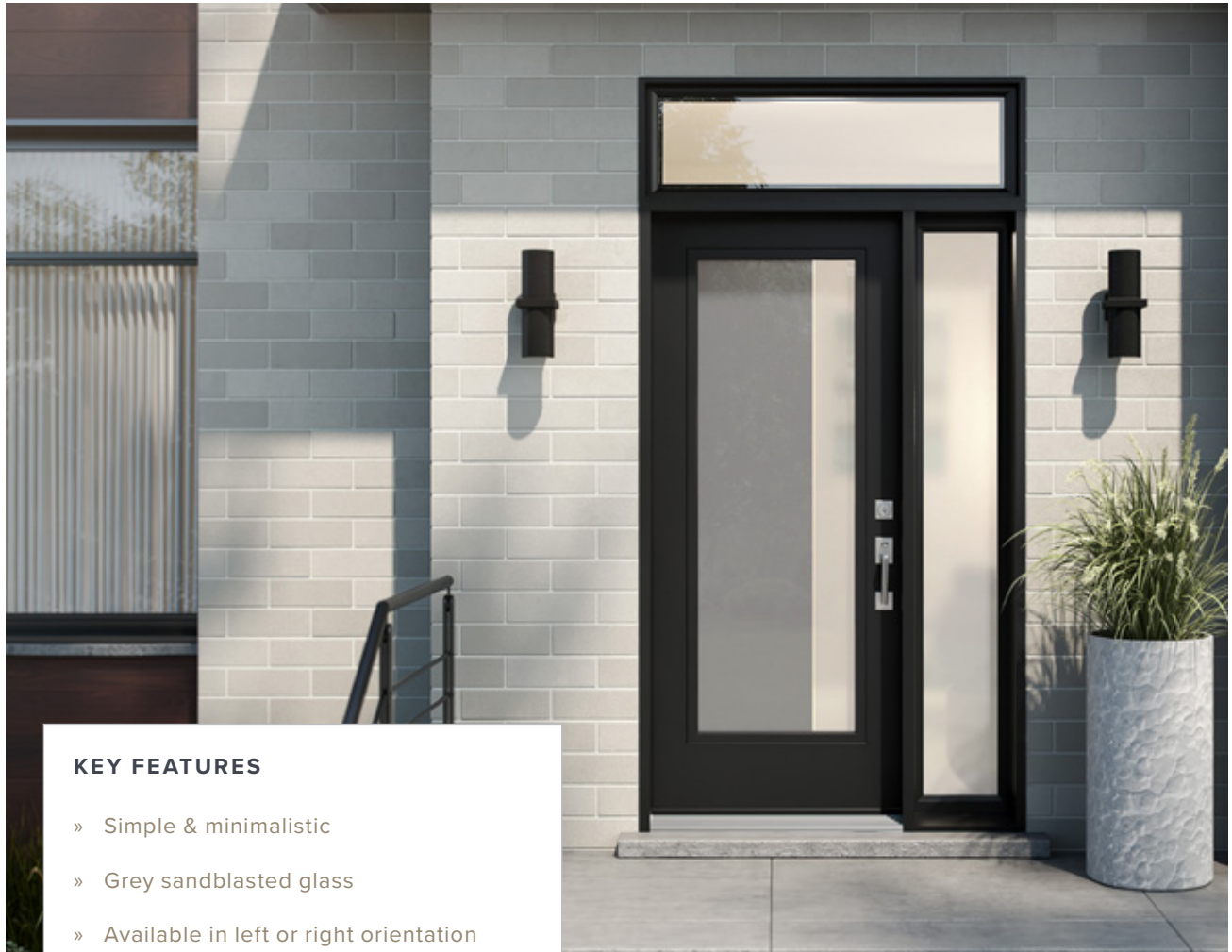

## KEY FEATURES

- » Simple & minimalistic
- » Grey sandblasted glass
- » Available in left or right orientation

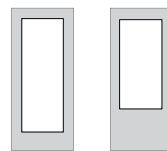
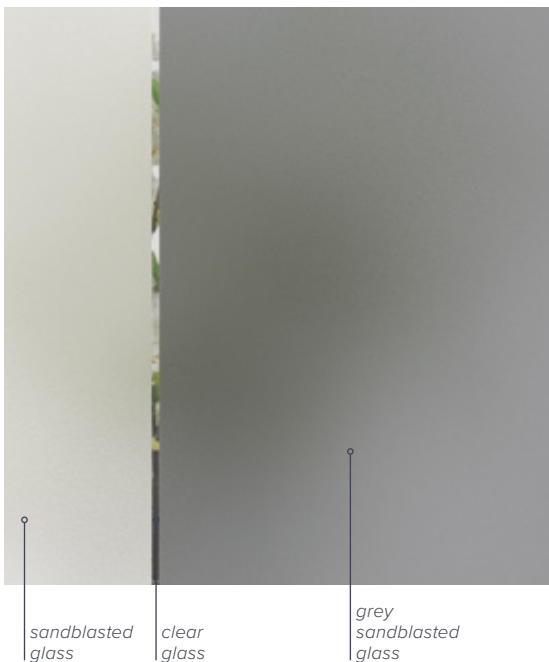

## PRIVACY RATING

\$\$\$



Explore all available styles on page **110**

# OPAL

OPAL 404 3/4 lite in a steel slab



### KEY FEATURES

- » Adds elegance to your architecture
- » Zinc caming
- » Provides privacy with timeless style

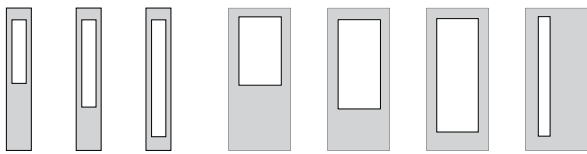

\$\$\$\$

### PRIVACY RATING



zinc  
caming

beveled  
satin  
glass

beveled  
clear  
glass

Explore all available styles on page **112**

PANAMA® 404 3/4 lite in a smooth fiberglass slab with 450 3/4 sidelites

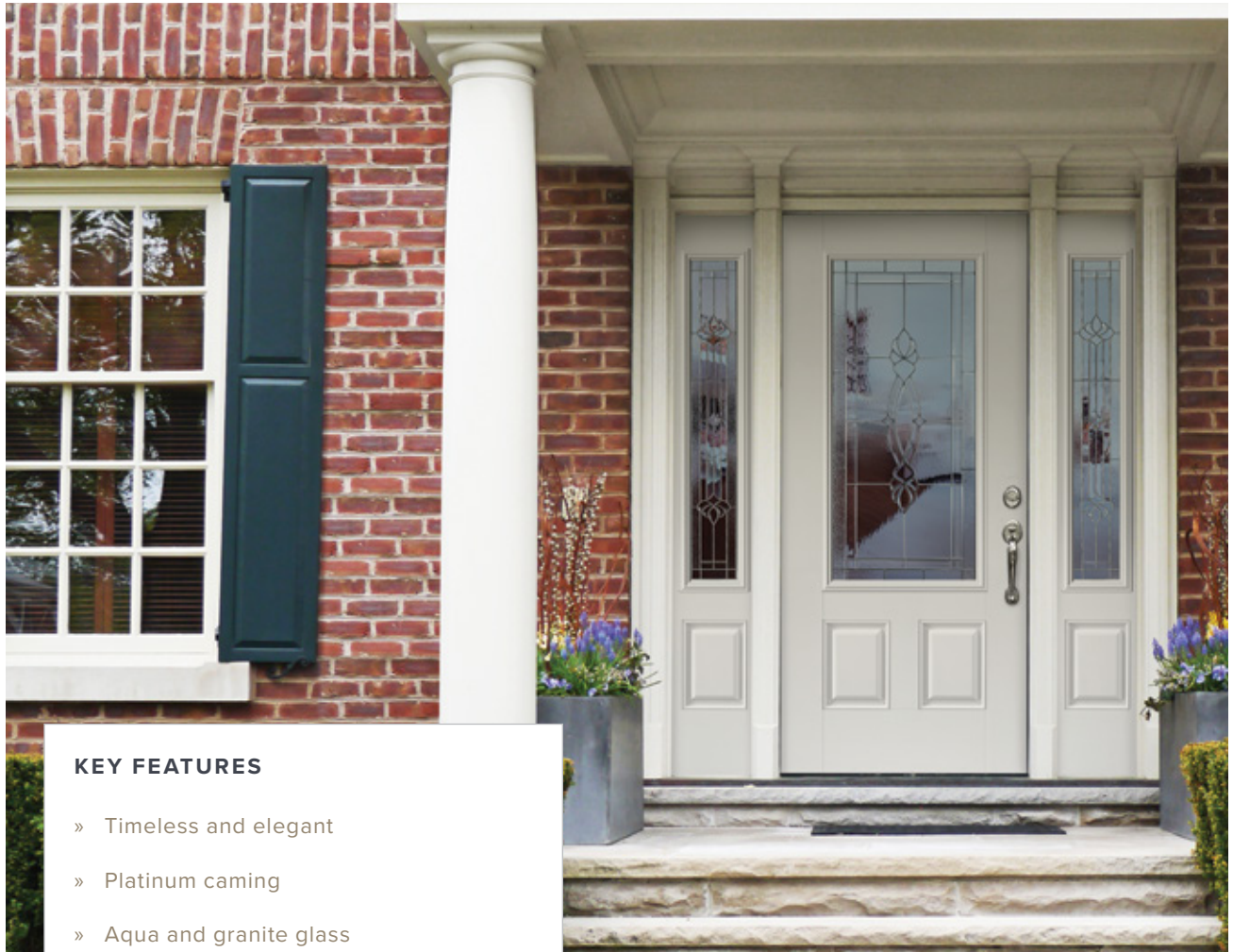

**KEY FEATURES**

- » Timeless and elegant
- » Platinum caming
- » Aqua and granite glass



granite textured glass    platinum caming    aqua textured glass    clear beveled glass

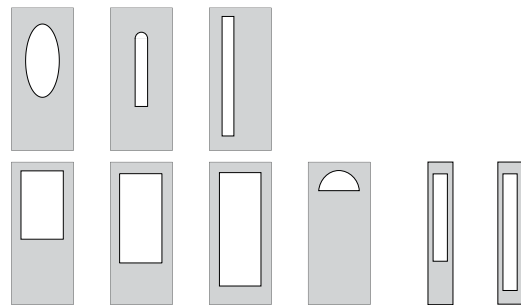

**PRIVACY RATING**

\$\$\$\$



Explore all available styles on page 112

# PEAR

PEAR 152 full lite in a smooth fibreglass slab

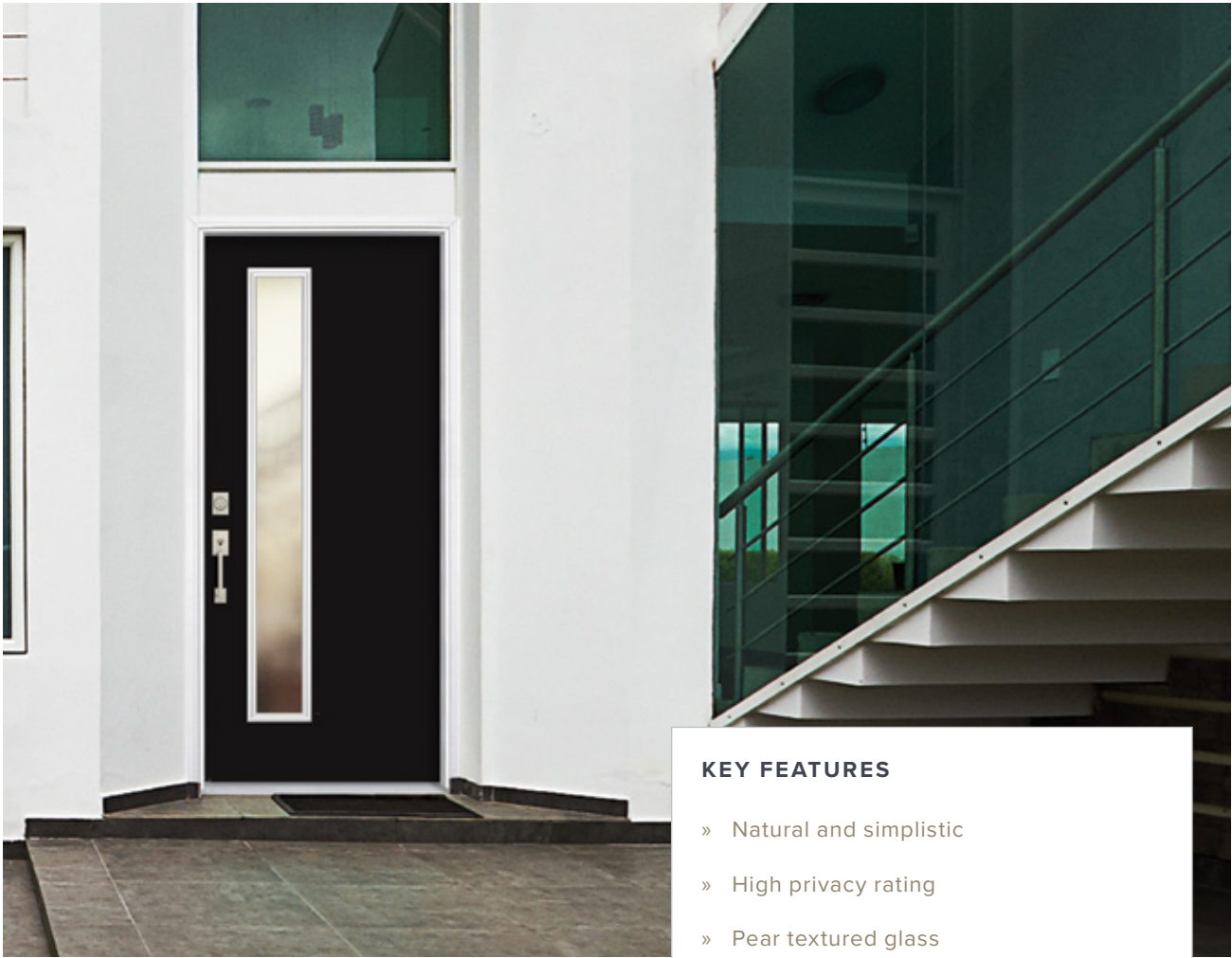

## KEY FEATURES

- » Natural and simplistic
- » High privacy rating
- » Pear textured glass

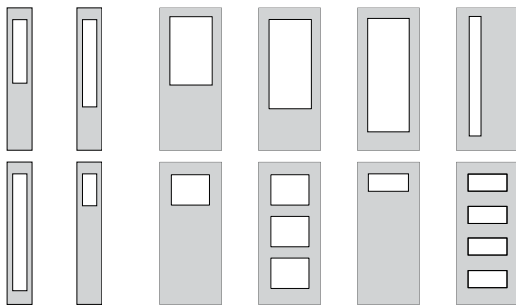

\$\$

PRIVACY RATING



pear  
textured  
glass

Explore all available styles on page **112**



PEARL® 926 full lite in a VistaGrande™ smooth fibreglass slab

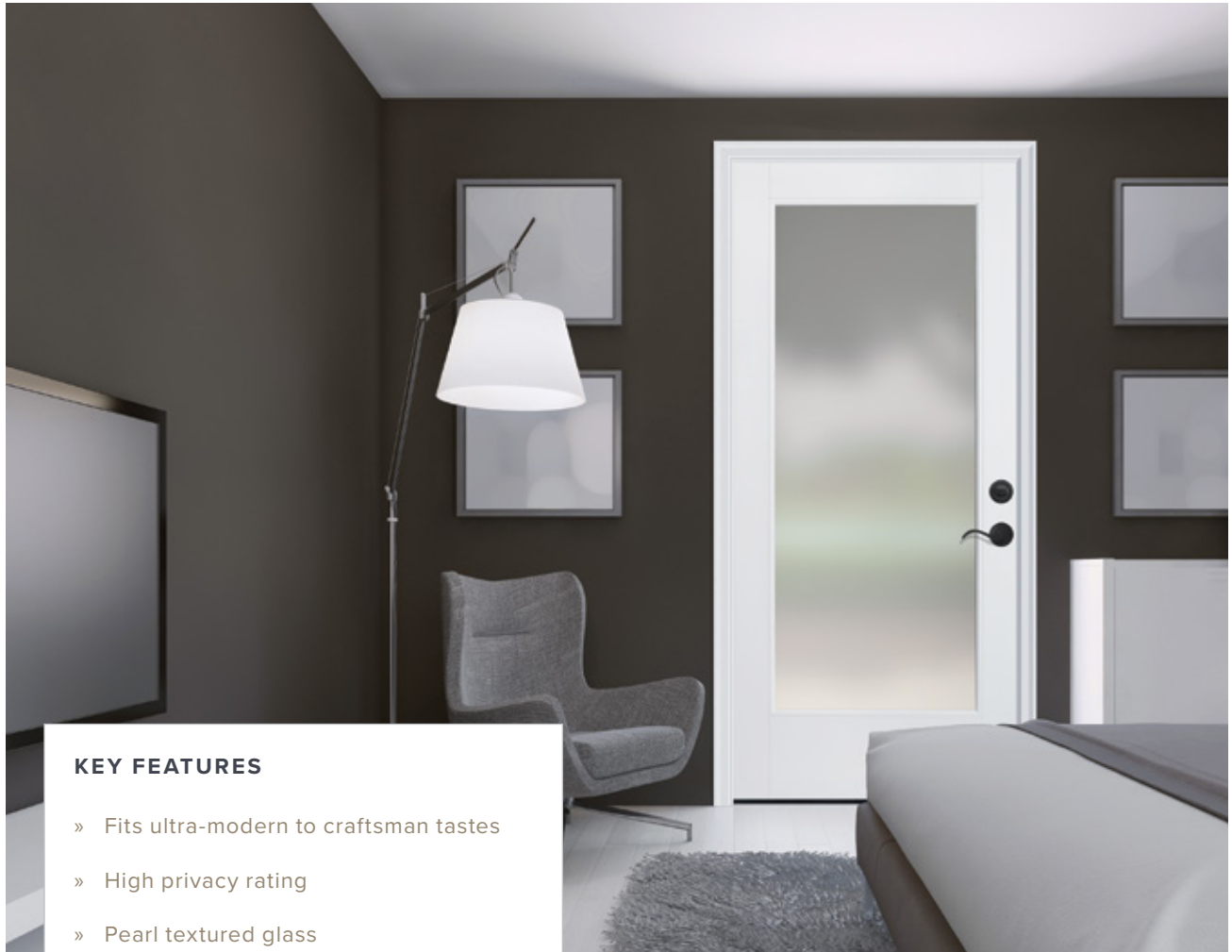

**KEY FEATURES**

- » Fits ultra-modern to craftsman tastes
- » High privacy rating
- » Pearl textured glass

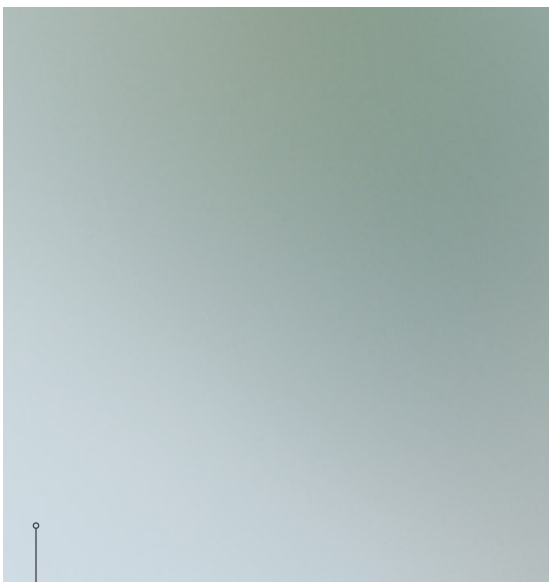

pearl  
textured  
glass

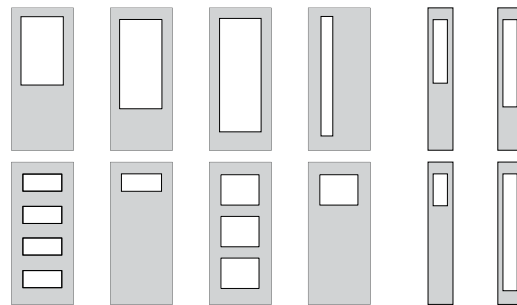

**PRIVACY RATING**

\$\$

1 2 3 4 5 6 7 8 9 10

least obscure

most obscure

Explore all available styles on page **112**

# PURE

PURE 122 full lite in a smooth fibreglass slab

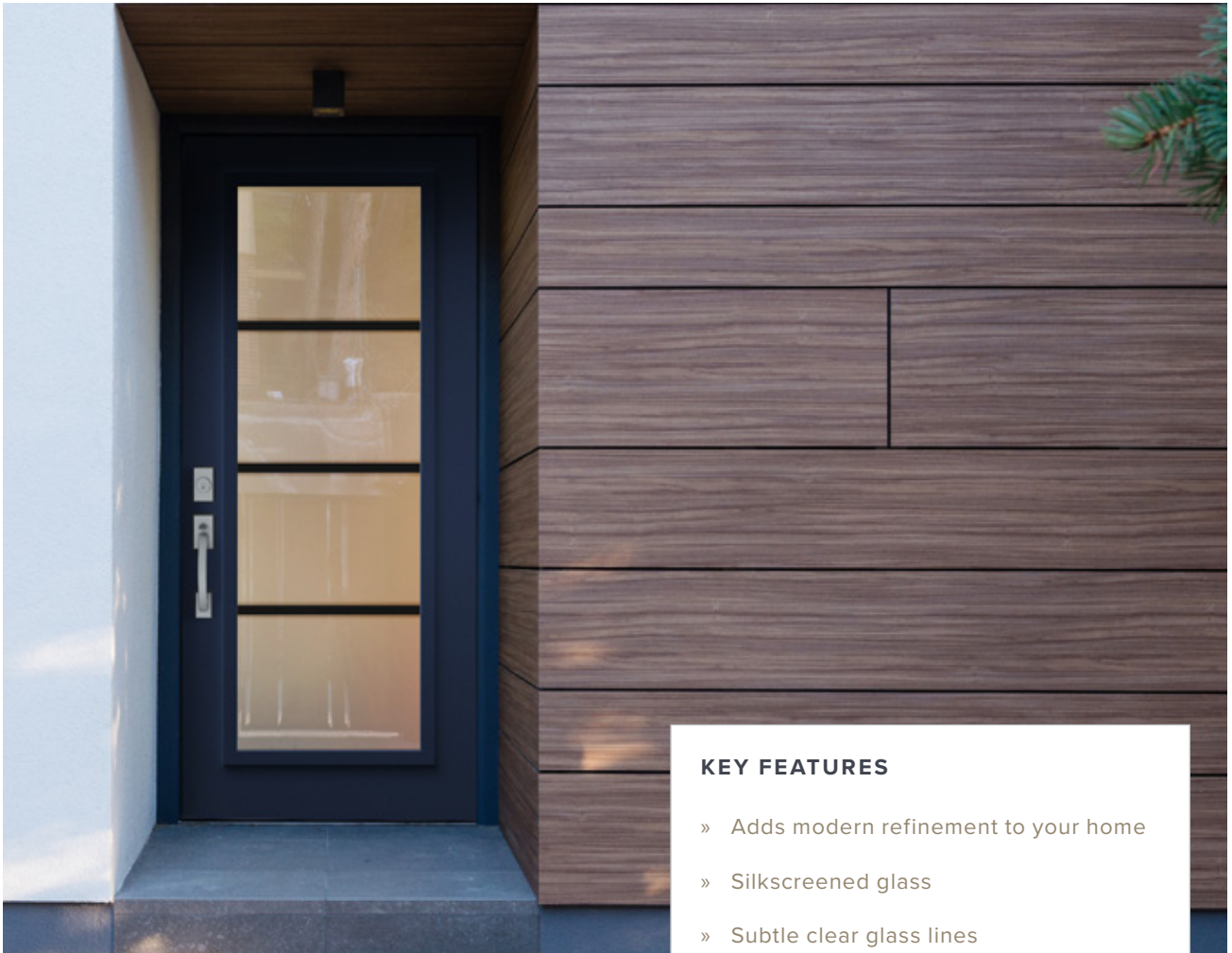

## KEY FEATURES

- » Adds modern refinement to your home
- » Silkscreened glass
- » Subtle clear glass lines

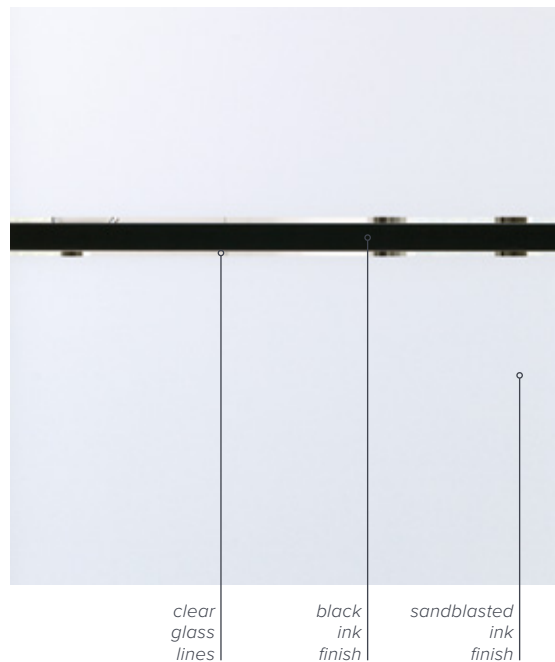
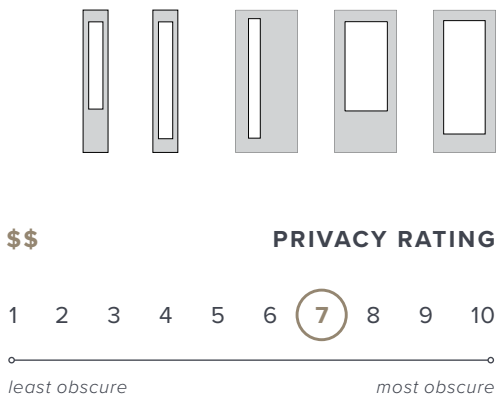

Explore all available styles on page **112**

ROYSTON 122 full lite in a oak textured fiberglass slab with 152 full sidelites

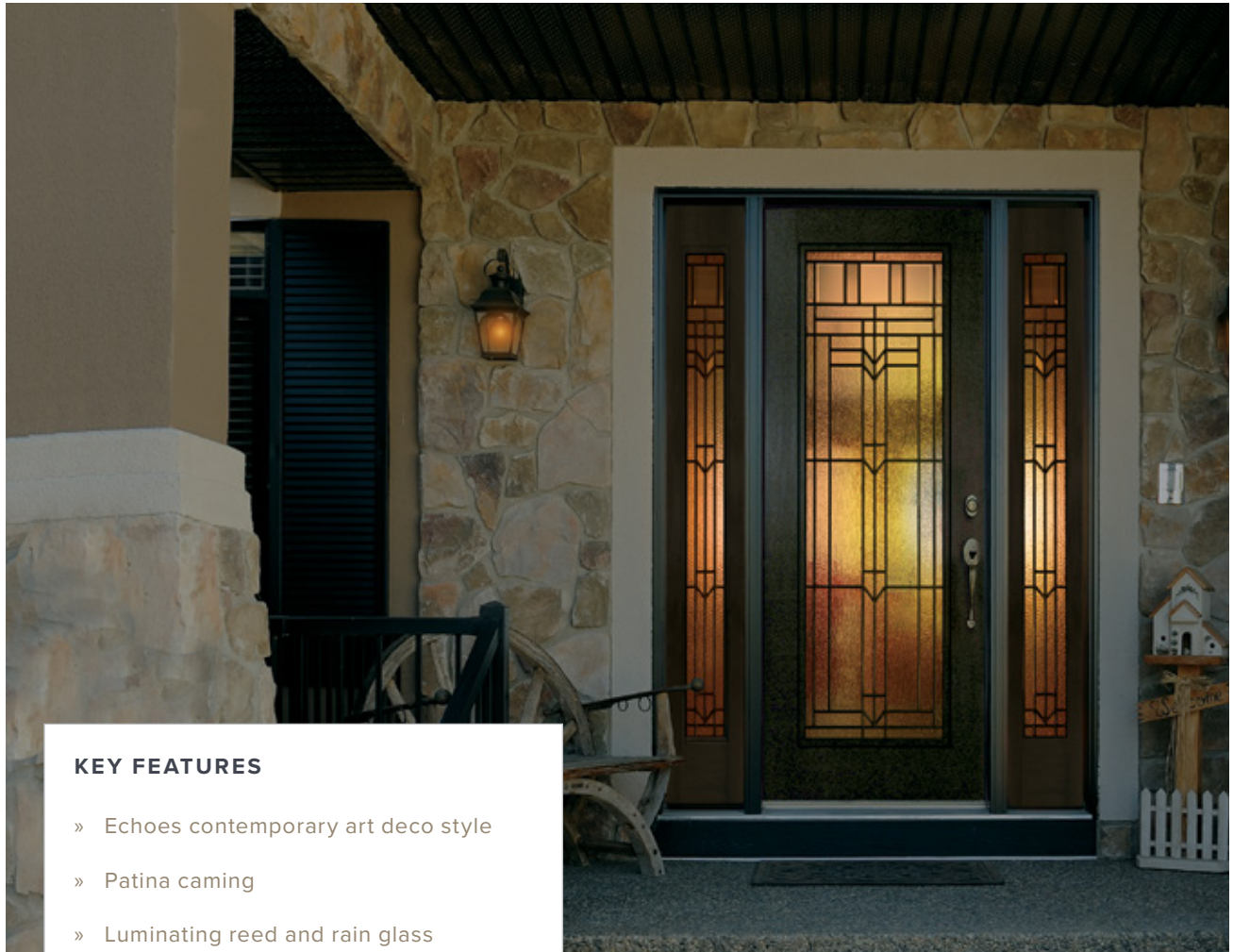

### KEY FEATURES

- » Echoes contemporary art deco style
- » Patina caming
- » Luminating reed and rain glass



clear beveled glass granite textured glass rain textured glass patina caming luminating reed glass

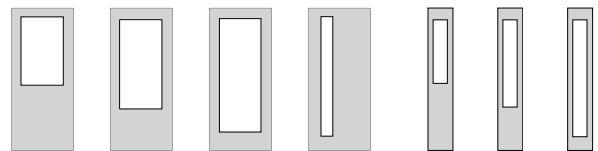

### PRIVACY RATING

\$\$\$\$

1 2 3 4 5 6 7 **8** 9 10

least obscure

most obscure

Explore all available styles on page **112**

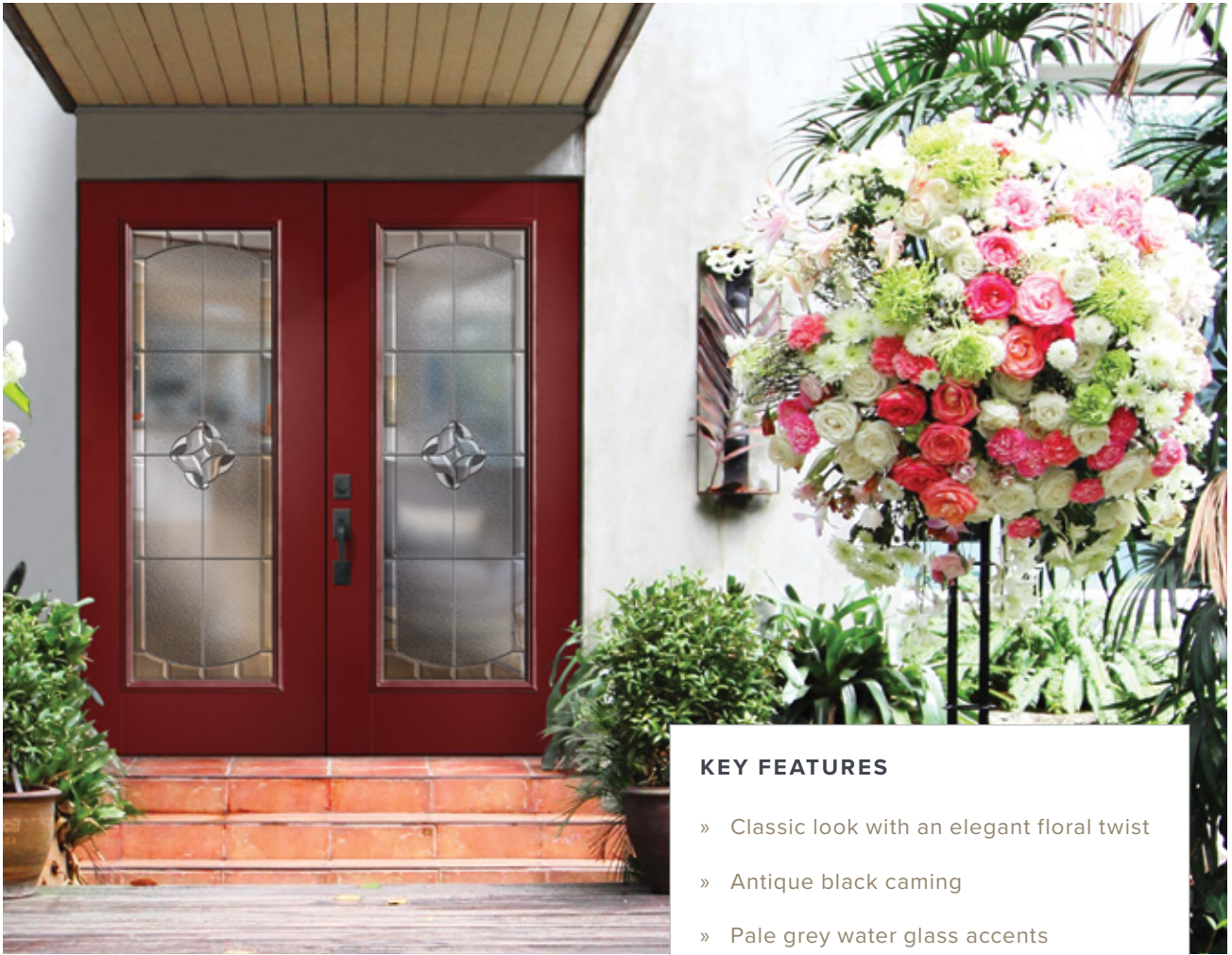

**KEY FEATURES**

- » Classic look with an elegant floral twist
- » Antique black caming
- » Pale grey water glass accents

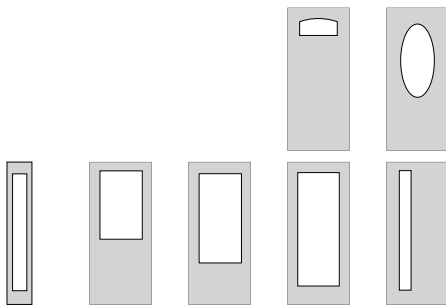

\$\$\$

**PRIVACY RATING**



pear textured glass | pale grey water glass | antique black caming | granite textured glass | clear beveled glass

Explore all available styles on page 112

SOFT 122 full lite in a steel slab with a 152 full sidelite



- KEY FEATURES**
- » Unconventional upholstered pattern
  - » High privacy rating
  - » Soft textured glass

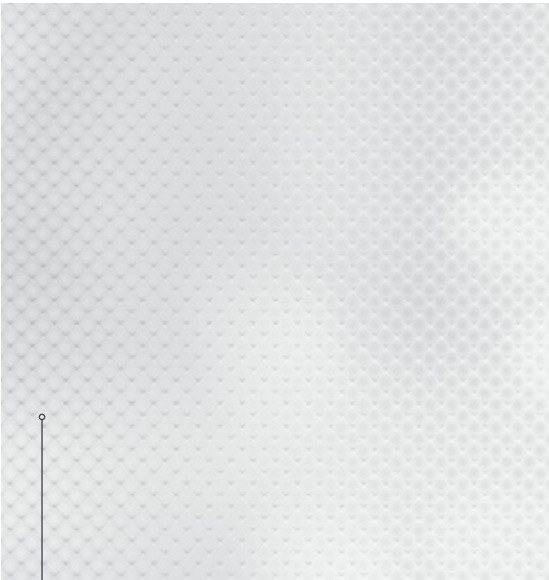

soft textured glass

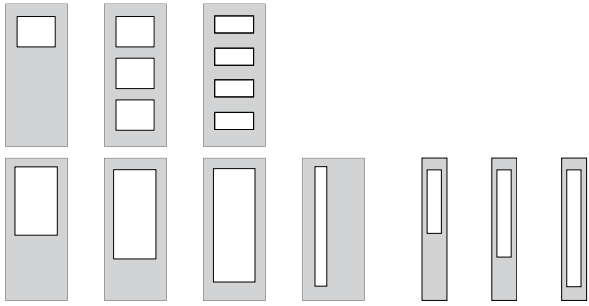

PRIVACY RATING \$\$\$\$



Explore all available styles on page 112

# TEXTURED & CLEAR

**CLEAR** 217 lite in a fir textured fiberglass slab with matching 617 sidelites and clear transom



## KEY FEATURES

- » Ultimate choice in versatility
- » Available in dual or triple pane
- » Add internal grille or SDL (see page 101)

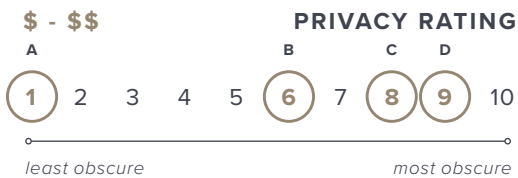
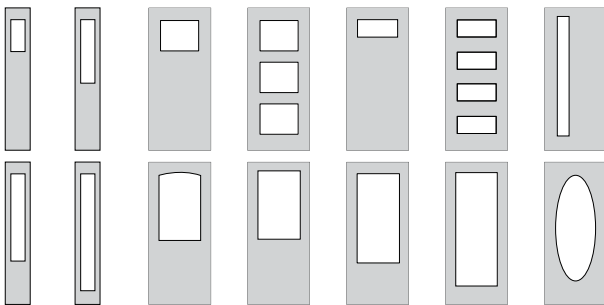

Explore all available styles on page **114**

TRANSIT 122 full lite in a smooth fibreglass slab

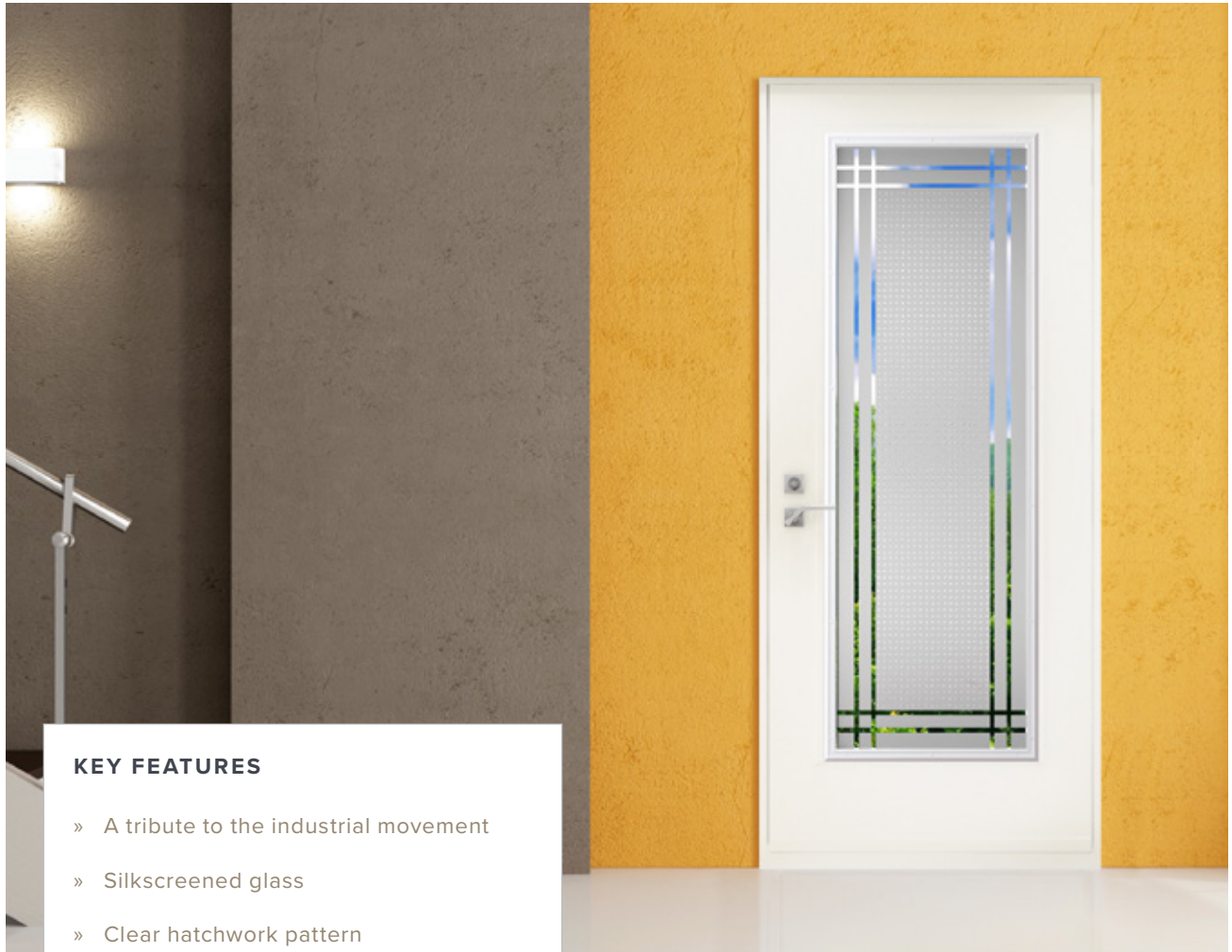

## KEY FEATURES

- » A tribute to the industrial movement
- » Silkscreened glass
- » Clear hatchwork pattern



clear glass

sandblasted ink finish

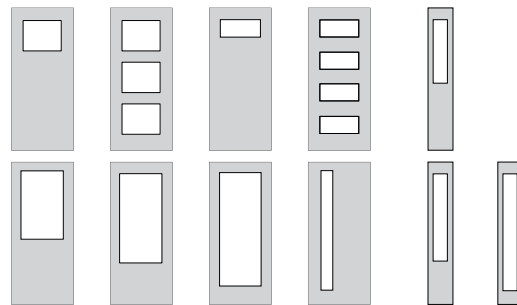

## PRIVACY RATING

\$\$

1 2 3 4 5 6 7 8 9 10

least obscure

most obscure

Explore all available styles on page **114**

# VENTING & INTERNAL BLINDS

INTERNAL BLINDS 122 full life in a smooth fibreglass door

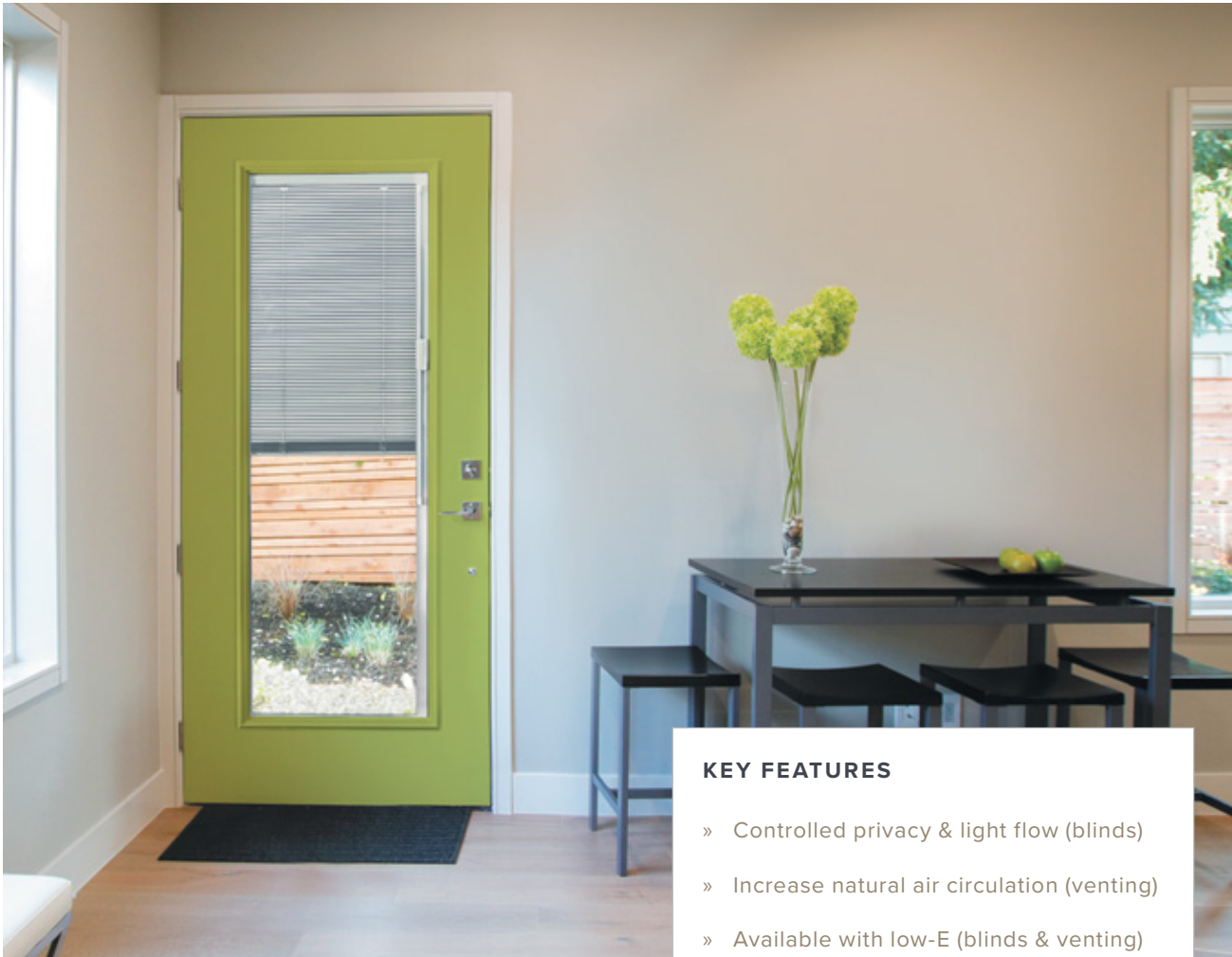

## KEY FEATURES

- » Controlled privacy & light flow (blinds)
- » Increase natural air circulation (venting)
- » Available with low-E (blinds & venting)

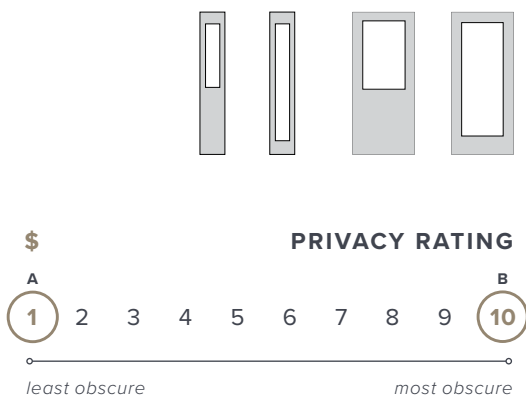

Explore all available styles on page **114**

Note: Internal blind inserts are not available in venting styles and do not have a raise/lower function on sidelite sizes. Venting inserts are not available in sidelite sizes.



VERSO 404 3/4 lite in a smooth fibreglass slab



**KEY FEATURES**

- » Homage to the art of glass cutting
- » V-groove & sandblasted glass
- » High privacy rating



polished  
v-groove  
lines

sandblasted  
glass

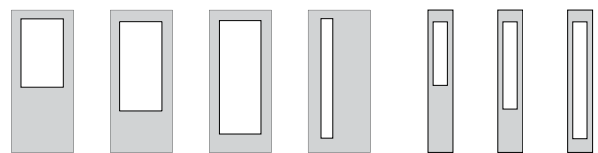

**PRIVACY RATING**

\$\$

1 2 3 4 5 6 7 **8** 9 10

least obscure

most obscure

Explore all available styles on page **114**

# WINCHESTER

WINCHESTER 404 3/4 lite in a smooth fibreglass slab with clear glass transom



## KEY FEATURES

- » Classic style in it's simplest form
- » Rich, contrasting mix of glass
- » Patina caming

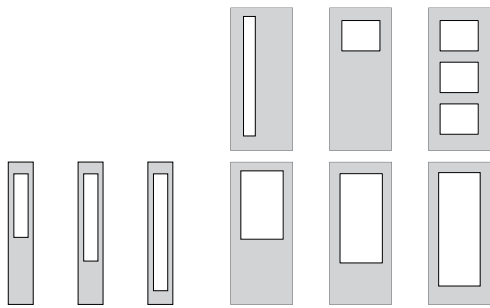

\$\$\$

## PRIVACY RATING



patina  
caming

clear  
beveled  
glass

satin  
finish  
glass

Explore all available styles on page **114**

ZENITH 122 full lite in a smooth fibreglass slab

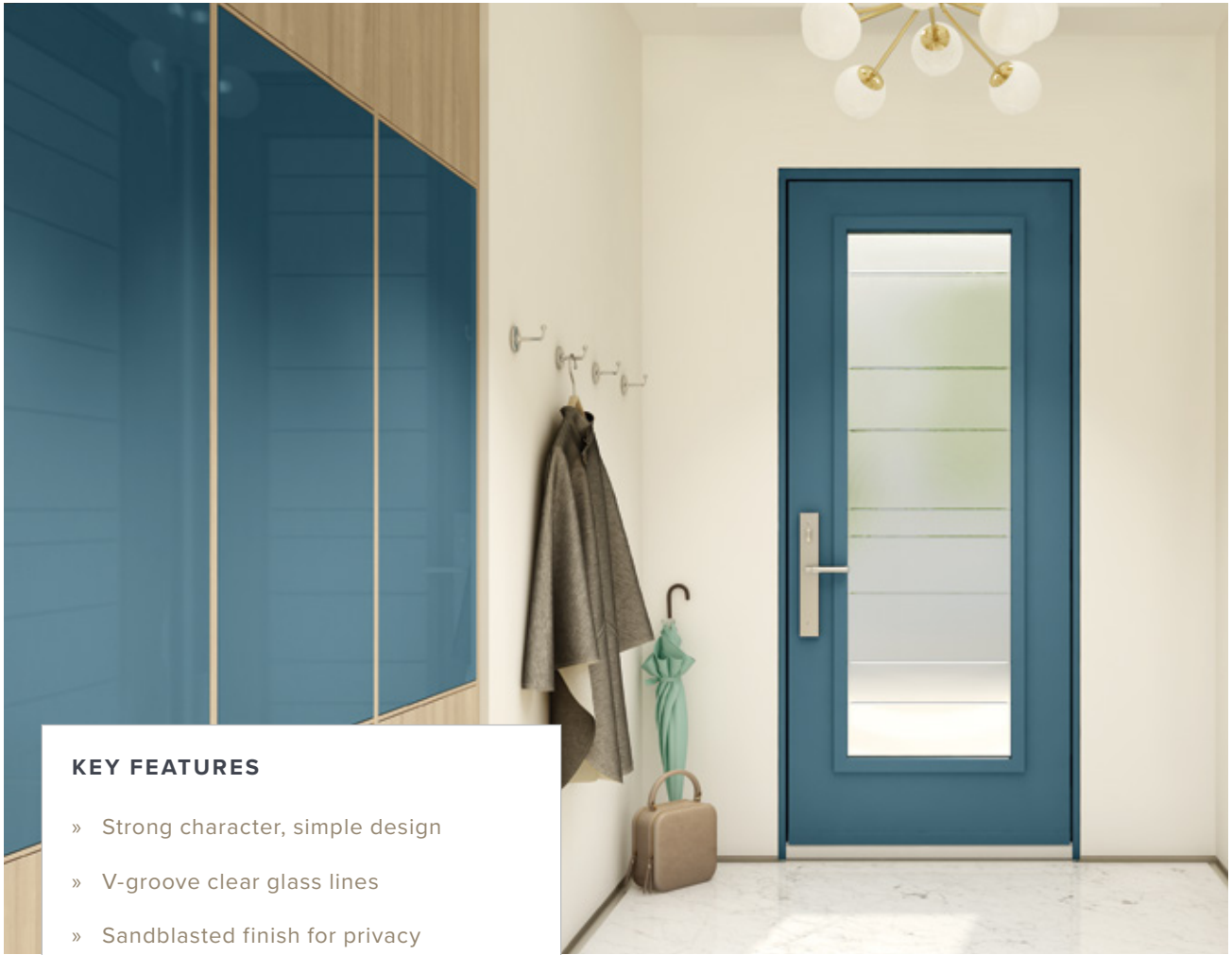

### KEY FEATURES

- » Strong character, simple design
- » V-groove clear glass lines
- » Sandblasted finish for privacy

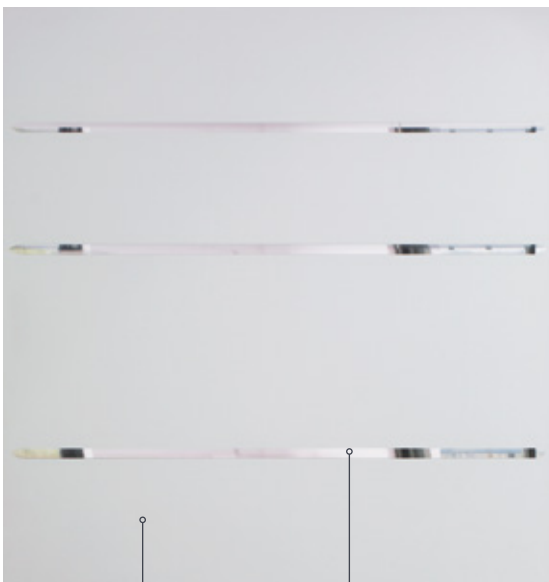

sandblasted glass

clear v-groove lines

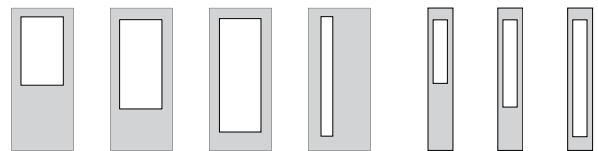

PRIVACY RATING

\$\$

1 2 3 4 5 6 7 8 9 10

least obscure

most obscure

Explore all available styles on page **114**

# BOLERO



**BOLERO** glass 47 smooth fibreglass door 38



## create

94	Operating Styles
95	Handing & Swing
96	Fire Rated Door System
98	NAFS & ENERGY STAR®
99	Entry Door System
100	Multilock Hardware
101	Grilles & SDL
102	Brickmould, Hinges & Striker Plates
103	Door Slab & Frame Finishes
104	Style Matrix
104	Decorative Lites A-Z
116	Craftsman Smooth & Mid-Century Modern
117	Panels
118	VistaGrande™
119	Slab Sizing
122	Rough Openings
124	How to Measure Your Door
125	Door Planner
126	Notes
130	Door Lite & Panel Legend
131	Index

# OPERATING STYLES

## MORE THAN JUST THE SWING

In or out? Left or right? Single or double? A transom perhaps? Maybe a sidelite or two? The options are endless. Designing your door can be as simple as matching an existing door or as complex as a multi-part configuration. It's all up to you. Be bold. Be creative!

## DOUBLE & GARDEN DOORS

Double and garden doors may seem similar, but there is one noticeable difference. Garden doors consist of one main operating door and one fixed or venting door with a stationary centre post. Double doors however, can be fully opened to create a single large opening. The centre post, known as an astragal, is attached to one of the two doors. The astragal post uses top and bottom flush-bolts to secure it into place when both doors are not in use.

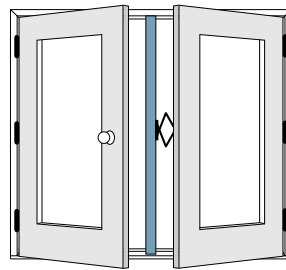

### GARDEN DOOR

*left door slab is operating, right door slab is venting. Centre post is stationary*

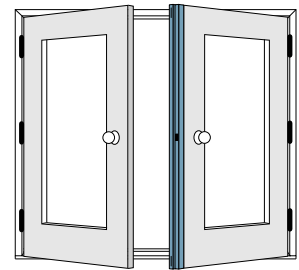

### DOUBLE DOOR

*left door slab is operating, right door slab is inactive with centre post (astragal) attached*

## SIDELITES

Sidelites not only enhance the look and size of your door, but they can also add additional benefits. Using a full glass sidelite can increase the amount of sunlight that enters into your home while maximizing the overall width of your door. Full glass sidelites can also be customized to varying widths. Adding venting panel sidelites can help promote airflow and increase ventilation. Sidelites are available in hundreds of styles to perfectly and seamlessly match your door.

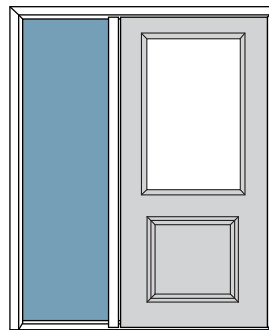

### FULL GLASS SIDELITE

*clear or textured sealed units are glazed directly into the door frame and cannot be vented (door shown as an outswing)*

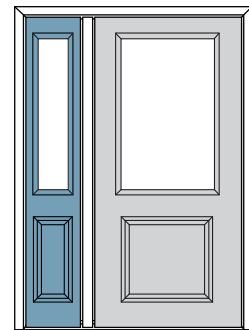

### PANEL SIDELITE

*12 or 14 inch door panels are either fixed into the door frame or vented out using a crank mechanism (door and sidelite shown as an outswing)*

## TRANSOMS

Limited by width? Why not go higher? Transoms allow increased sunlight into your home while increasing beauty and elegance. Transoms are fully customizable with a large selection of shapes, sizes and clear and textured glass options.

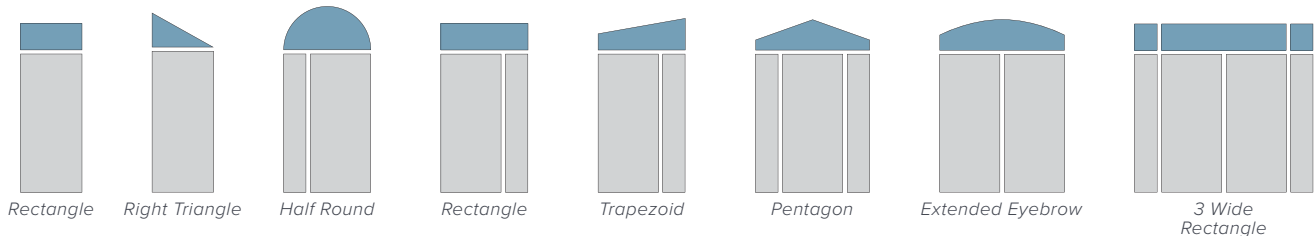

Note: Garden doors include an interior "in-frame" screen on the venting slab only. A sliding exterior screen is available on garden doors only when the following 3 conditions are met: 1) inswing configuration, 2) one slab is fixed, 3) 6-9/16" minimum jamb depth. Screens are not available on double door configurations. Venting sidelites may not meet current building codes for your area.

# HANDING & SWING

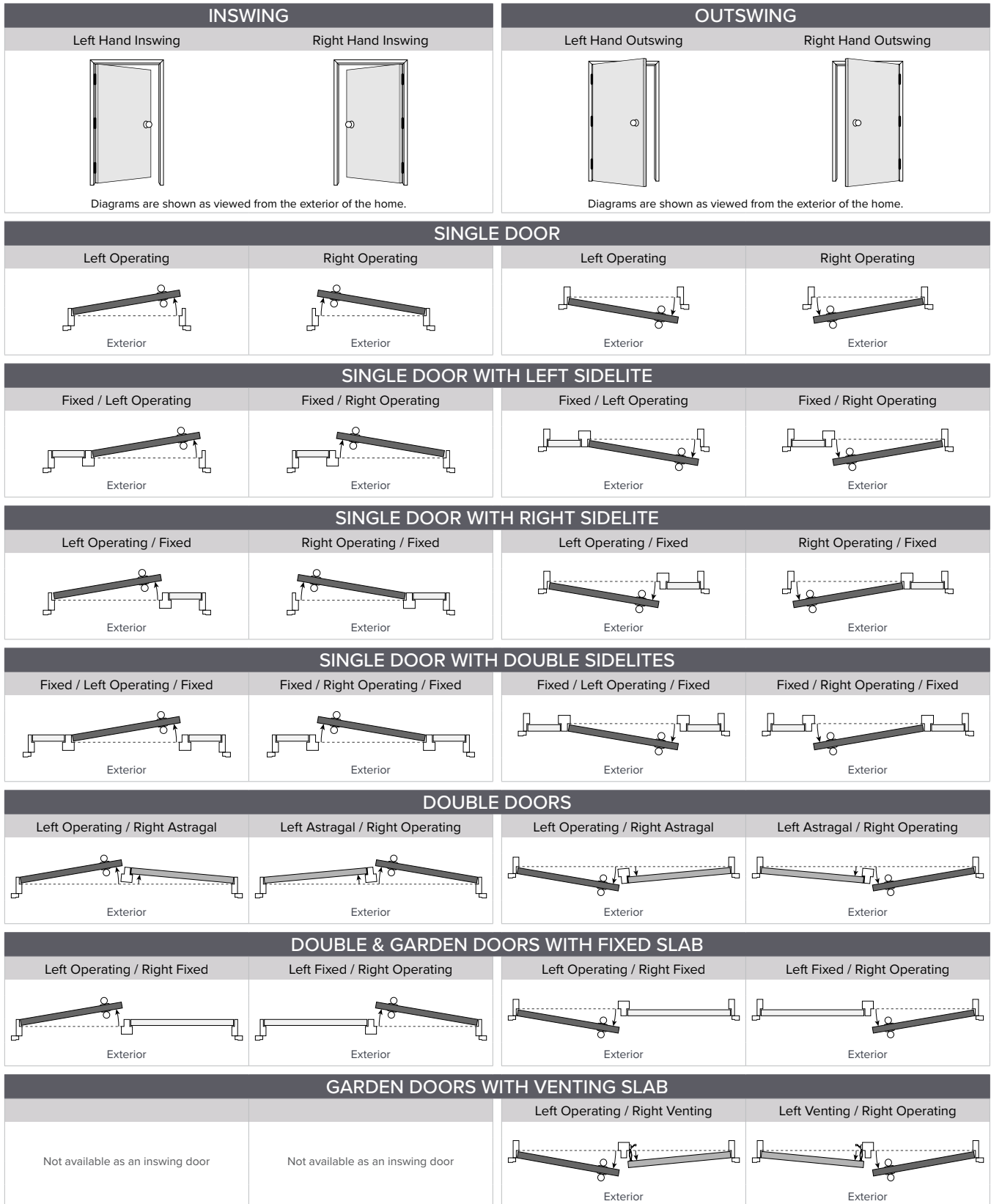

Note: Additional handing and swing options may be available depending on your door configuration. Talk to an All Weather Window representative to help you design a door that works best for you.

# FIRE RATED DOOR SYSTEM



## THE ULTIMATE FIRE RATED DOOR SYSTEM

Our 90-minute fire rated door system comes pre-hung and utilizes the innovative adjustable Fast-Frame® by Timely®. Fast-Frame's® advanced design adds a new dimension of flexibility and durability to our steel entry door line. Featuring a full 1" of adjustability, the frame can accommodate almost any variation of wall construction. This easy-to-install, user-friendly, kerfed white galvanized steel door frame system is applicable to a full range of residential and commercial applications—wood or steel stud construction. Our fire rated door system is engineered to meet the most stringent code requirements including structural, impact and 90-minute fire ratings.

A 20-minute option is also available and includes a wood finger joint pine (FJP) jamb.

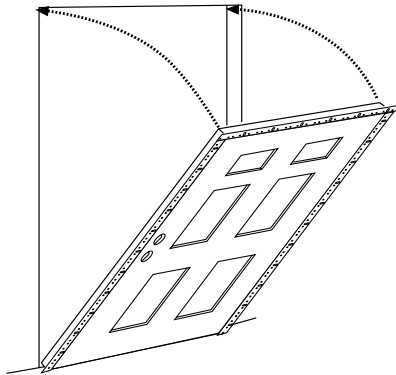

## FAST-FRAME® CONSTRUCTION<sup>1</sup>

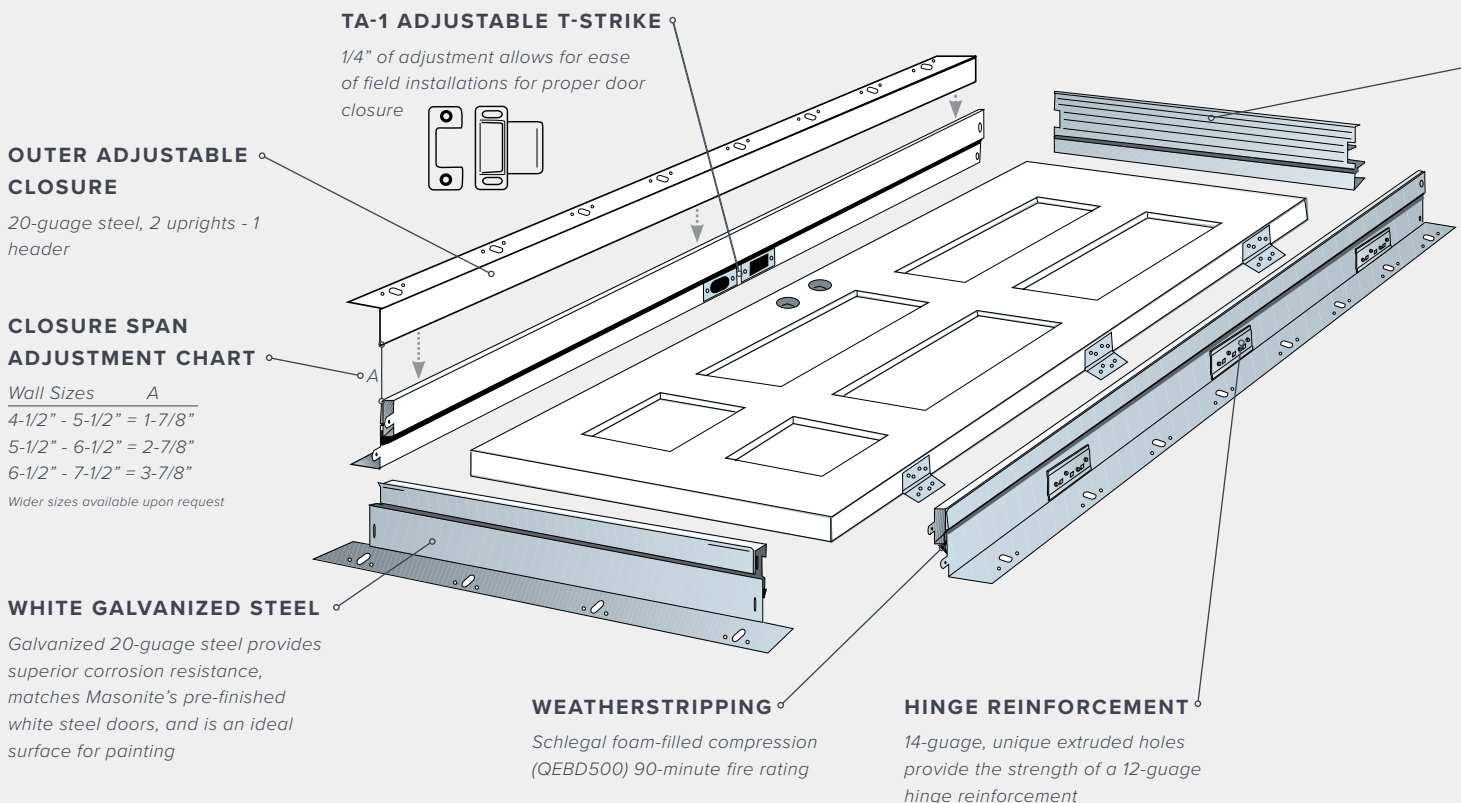

<sup>1</sup> Fast-Frame® is available on 90-minute fire rated door systems only.

Note: For more information on fire rating requirements and to order, please talk to an All Weather Windows representative. Extended lead times apply.



## FIRE LABELS

Our fire rated door systems include a 20 and 90-minute fire rating option. This includes all components of the door frame, steel door slab, hinges, and striker plates.



## WARRANTY

A 2 year limited manufacturer warranty against defects in materials and craftsmanship is included on all fire rated door systems.



## CLOSURE TEST

Fire rated door systems will close and latch from 18" if the following Fast-Frame<sup>®1</sup> components are used:

- » QEBD500 compression weatherstripping
- » factory sweep
- » adjustable T-strike
- » factory supplied sills
- » self-closing hinges

## DOOR STYLES

Both 20 and 90-minute options are available in a 6-panel steel skin slab. 90-minute doors also come with a steel flush slab option.

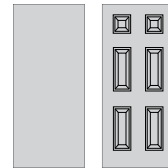

## FEATURE & SIZING AVAILABILITY

	20-MINUTE	90-MINUTE
Slab Construction	Wood Edge	Steel Edge
Jamb	Finger Joint Pine (FJP)	Steel Fast-Frame <sup>®</sup>
Glass Inserts	No	No
NAFS Compliance	No	No
Door Height	6' 8"	6' 8" & 8' 0"
Door Width	2' 8", 3' 0"	2' 6", 2' 8", 2' 10", 3' 0"
Frame Depth	4-9/16", 6-9/16"	4-9/16", 5-5/8", 6-5/16"
Door Swing	Inswing Only	Inswing (5-5/8" & 6-5/16") Outswing (4-9/16")
Door Slab Style	6 Panel Only	6 Panel & Flush

## ROUGH OPENINGS

FIRE RATED DOOR SIZING & ROUGH OPENINGS		
	Nominal Door Size	Rough Opening Size (wood stud)
6'8" Height	2'6" x 6'8"	31-1/4" x 81-3/8"
	2'8" x 6'8"	33-1/4" x 81-3/8"
	2'10" x 6'8"	35-1/4" x 81-3/8"
	3'0" x 6'8"	37-1/4" x 81-3/8"
8'0" Height	2'8" x 8'0"	33-1/4" x 97-3/8"
	2'10" x 8'0"	35-1/4" x 97-3/8"
	3'0" x 8'0"	37-1/4" x 97-3/8"

Note: All dimensions shown are for doors with a standard inswing sill  
Deduct 13/16" for bumper, outswing or handicap compliant sills

### FAST-FRAME<sup>®</sup> SILLS<sup>1</sup>

#### STANDARD INSWING

Thermally broken - 5-5/8" width with optional extenders  
Note: Not for use on outswing applications



#### BUMPER OUTSWING

4-9/16" width with integrated weather seal.  
Note: Not for use on inswing applications.

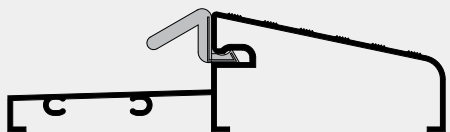

#### HANDICAP (ADA)

Double slope 4-9/16" & 6-9/16" widths

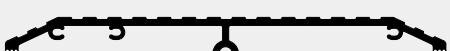

STRUCTURAL PERFORMANCE & IMPACT RATING: Design pressure ratings are available for compliance with national, state and local wind load and/or missile requirements. Product tested for structural and impact performance in accordance with TAS 201, 202, and 203. Product approval available under the Florida Department of Community Affairs (FL10357). Note: Structural and Impact performance requires use of a hurricane grade 5/8" T-astagal for double doors.

# NAFS

## WHAT IS NAFS?

The North American Fenestration Standard (NAFS) is designed to combine the fenestration testing and ratings process into a harmonized North American Standard. It has been incorporated into the National Building Code of Canada and implemented across Canadian provinces.

NAFS Certification requires stringent standards be met for:

- » Air tightness
- » Water penetration resistance
- » Structural performance under wind loads
- » Forced entry resistance

*All Weather Windows offers NAFS tested and certified windows and doors, available in nearly every product series and configuration\*. Each NAFS certified product is clearly labeled, outlining the PG value and any specific ratings such as water and air resistance values.*



## PERFORMANCE GRADE & CLASS<sup>1</sup>

Ratings are based on a combination of a product's structural properties and its ability to resist water. As a result, a single numeric rating is assigned to each product. This rating is called the **PERFORMANCE GRADE (PG)**.

NAFS has also categorized the application of fenestration products into four groups. Each of these groups is called a **PERFORMANCE CLASS**. Each class requires products that meet a minimum performance grade.

The performance classes and applicable minimum performance grades are:

- R:** Residential (one and two family) - minimum PG15
- LC:** Light Commercial (low rise and multi-family dwellings) - minimum PG25
- CW:** Commercial Window (low rise and multi-family dwellings, higher loads and larger sizes) - minimum PG30
- AW:** Architectural Window (mid to high rise buildings, high exposure conditions) - minimum PG40

To help you determine NAFS requirements for your region, please visit [www.fenestrationcanada.ca/calculator](http://www.fenestrationcanada.ca/calculator)

# ENERGY STAR®



ENERGY STAR® is a government backed program to help consumers identify energy efficient products. It is a voluntary program administered by Natural Resources Canada.

All Weather Windows products are labeled with an ENERGY STAR® label outlining product performance and zone ratings. Depending on the product and configuration, zone ratings will vary. Talk to an All Weather Windows customer service or sales representative or visit [allweatherwindows.com/energy-efficiency](http://allweatherwindows.com/energy-efficiency) for more information.

<sup>1</sup>NAFS performance grade (PG) requirements can vary by region and/or terrain type. Not all options/configurations may meet your area's specific requirements. Check with an All Weather Windows sales representative to help determine which products will best suit your requirements. ENERGY STAR® is a registered trademark of the U.S. EPA and is administered in Canada by Natural Resources Canada.

# ENTRY DOOR SYSTEM

## NOW EVEN TOUGHER

How do you improve on an entry door system that boasts superior drainage, robust construction and an enhanced seal for overall performance and stability? You listen to customer feedback, review its performance in the field, and build it even better with plenty of cool new options. Combine that together and you have our NEW All Weather Windows entry door system. Our latest entry door design includes improved sealing and key new features to protect you from the elements more effectively than ever.



## COMFORT IN, WEATHER OUT

Enhanced multilock, replaceable sill cover, and improved sealing, giving you greater protection from the elements. Our extended sill is designed to work with standard size aluminum storm doors.

*See page 100 for more details on our multilock system.*

## COMPOSITE JAMB OPTIONS

Optional low-maintenance smooth composite jamb offers higher durability and resists moisture, rot and mildew. Available in white - or add black wrap for additional style.

## NAFS READY & CERTIFIED<sup>2</sup>

To meet the stringent North American Fenestration Standards (NAFS), our doors come with the option to be fully NAFS certified.<sup>2</sup>

<sup>2</sup>NAFS certification available by request only at the time of order. NAFS performance grade (PG) requirements can vary by region and/or terrain type. Not all options/configurations may meet your area's specific requirements. Check with an All Weather Windows sales representative to help determine which products will best suit your requirements.

# MULTILOCK HARDWARE

## THE 3-POINT DIFFERENCE

To create the ultimate weather-proof seal, All Weather Windows offers a 3-point multilock door hardware system. This innovative locking system is smart, sophisticated, and packed with features making it the optimal choice in security and performance. These features include:

- » Active hardware in 3-point hook and claw<sup>1</sup> mechanism for a tighter seal
- » Unique “Duo-Glide” lock mechanism. Superior to standard single drive systems, the “Duo-Glide” two-way action balances the lock system providing smoother, quieter, and easier operation. “Duo-Glide” allows for the lock points to engage in tension rather than compression thereby reducing stress on other elements of the lock system for longer life
- » Anti-slam device for added safety and gasket protection
- » Laminated stainless steel deadbolt with anti-saw pin
- » Anti-back drive feature prevents tampering
- » Latch wear strip prevents marring the centre of the striker plate
- » 90 degree thumb-turn deadbolt operation located above the handle

Through superior craftsmanship, materials and handle styles, our multi-point hardware takes the guesswork out of selecting the right hardware for your door. With a wide selection of premium finishes, you'll be sure to perfectly match your door with the rest of your home's finishes.

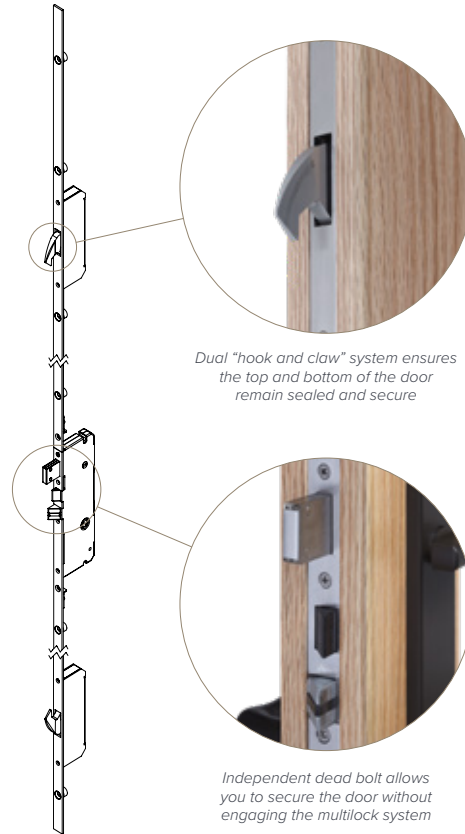

3-Point "Hook & Claw"  
Multilock Assembly

## MULTILOCK HARDWARE STYLE OPTIONS



## MULTILOCK HARDWARE FINISH OPTIONS



<sup>1</sup>Shoot bolt system is used for passive hardware on a double doors with astragal post.

<sup>2</sup>Athena and Stuttgart handles are available in Flat Black, Satin Nickel and Oil Rubbed Bronze only.

<sup>3</sup>Satin Nickel is available on Athena and Stuttgart handle styles only.

## TAKE YOUR DOOR TO THE NEXT LEVEL

Make a lasting impression and an unforgettable look by adding internal grilles or SDL's to your entry door. Internal grilles and SDL's add a touch of elegance and give your door a traditional feel.

## INTERNAL GRILLES

Internal grilles are installed between panes of glass, leaving the exposed interior and exterior glass smooth and easy to clean. Grilles provide a beautiful look of divided light, while being virtually maintenance free.

### GRILLE FINISHES

	Black	Gold	Lead	Patina	White	Wicker
5/16"	•	•	•	•	•	•
5/8"	•	•		•	•	•
1"		•		•	•	•
1" Split (white/black)	•					
5/8" Georgian		•	•	•	•	•



### GRILLE SPLIT FINISHES

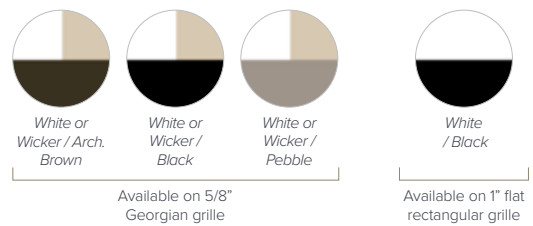

### GRILLE PATTERNS<sup>1</sup>

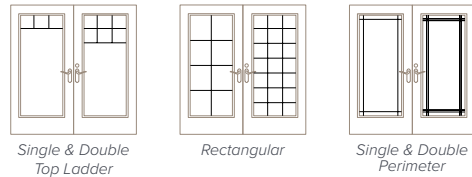

### GRILLE SIZES

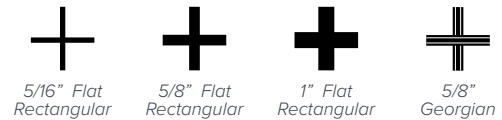

## SDL (SIMULATED DIVIDED LITES)

Simulated Divided Lites (SDL) are installed on the exterior and interior of the glass surface to simulate the look of divided panes of glass. Traditionally, individually divided panes of glass reduce energy efficiency by creating multiple seams and joints for every pane. With the simulated design, you get the beautiful look of divided glass, without sacrificing energy efficiency.

### SDL PATTERNS<sup>1</sup>

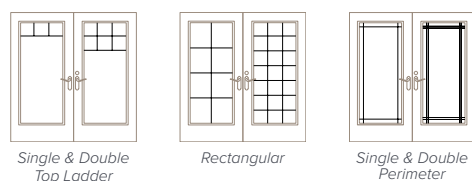

### SDL SIZES



<sup>1</sup>Available on clear and textured glass only (see page 86). Not available on decorative glass.

# BRICKMOULD, HINGES & STRIKER PLATES

## BRICKMOULD

Brickmould is the moulding that fills the gap between where the door and wall meet. Our aluminum 3/4" slimline brickmould includes an integrated nail flange, while our 2" renovation option boasts a discreet screw channel and cover, making it the perfect choice for replacing your existing door.

In addition to our aluminum brickmould options, we offer primed wood brickmould in 3 different profiles.

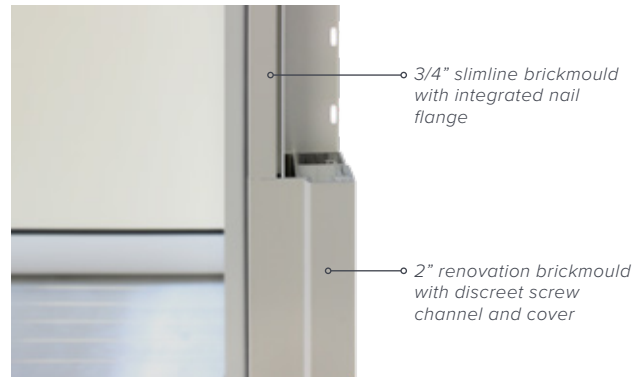

## HINGES & STRIKER PLATES

Premium 4-1/2" hinges with a 5/8" radius are included on all doors in a variety of finishes to perfectly compliment the rest of your hardware. For a smoother and quieter swing, upgrade to ball bearing hinges or choose self-closing to ensure your door always remains closed. Our doors also include adjustable striker plates to ensure easy maintenance and the best possible door seal.

### HINGES



Regular Hinge

Ball Bearing Hinge

Self-Closing Hinge

### STRIKER PLATES



Double Adjustable Striker Plate

Single Adjustable Striker Plate

## HINGE & STRIKER PLATE FINISHES



	Black	Brass	Brushed Brass	Oil Rubbed Bronze	Satin Chrome	Stainless Steel
<b>HINGES</b>						
Regular Hinge		•			•	
Ball Bearing Hinge	•		•	•	•	•
Self-closing Hinge	•	•		•	•	
<b>STRIKER PLATES</b>						
Double Adjustable Striker Plate	•	•			•	
Single Adjustable Striker Plate	•	•			•	
Single Striker Plate (Multilock)					•	

Note: Doors with both deadbolt and lockset drilling include a double adjustable striker plate while doors with only lockset drilling include a single adjustable striker plate. Doors with multilock hardware do not come with adjustable striker plates.

# DOOR SLAB & FRAME FINISHES

## PRE-PAINTED AND PRE-STAINED DOOR SLAB FINISHES

Offering superior durability, extended service life and exceptional chemical resistance, our pre-painted doors offer a professionally-finished solution. Available on smooth fibreglass and woodgrain textured fibreglass door slabs, choose from a variety of stunning factory-applied paint and stain finishes.<sup>1</sup>

### PAINT FINISHES

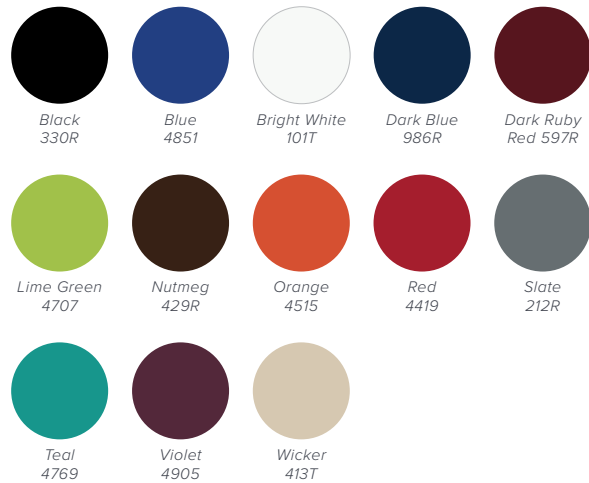

### STAIN FINISHES



## EXTERIOR CLADDED DOOR FRAME FINISHES

All door frames come standard with a metal cladded exterior which protects the door frame while adding colour and a seamless finish. With a wide selection of standard and premium colour finishes to choose from, you are sure to find the perfect match for your home and style.

### EXTERIOR METAL CLAD COLOURS<sup>2</sup>

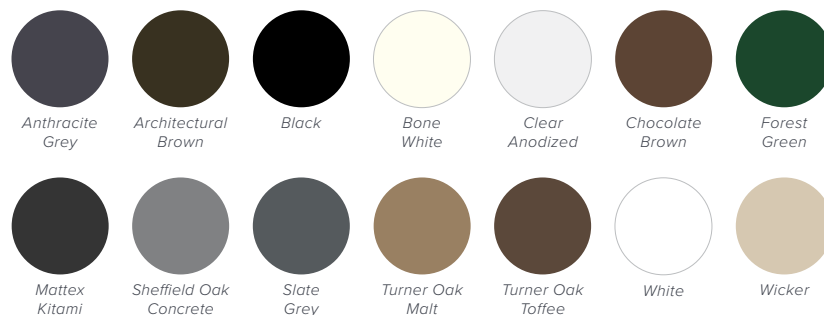

<sup>1</sup>Actual colours may vary. Available on fibreglass doors only. Finishing includes all 6 sides of door slab and glass insert frames (if applicable). Finishing is not offered on door frame components, including exterior frame and interior jamb.  
<sup>2</sup>Actual colours may vary. Premium colours have an additional upcharge including a colour setup fee and may have an extended lead time. Options shown do not apply to steel adjustable Fast-Frame®.

# STYLE MATRIX - DECORATIVE LITES

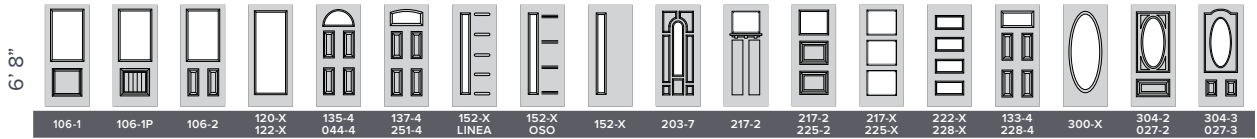

	106-1	106-1P	106-2	120-X 122-X	135-4 044-4	137-4 251-4	152-X LINEA	152-X OSO	152-X	203-7	217-2	217-2 225-2	217-X 225-X	222-X 228-X	133-4 228-4	300-X	304-2 027-2	304-3 027-3
ADELAIDE	Mahogany		•	•	•													
	Fir																	
	Oak			•	•						•							
	Smooth	•	•	•	•						•							
	Steel	•	•	•	•			•	•	•								
ALYS	Mahogany		•	•	•												•	
	Fir																	
	Oak			•	•		•				•						•	
	Smooth	•	•	•	•		•				•						•	
	Steel	•	•	•	•		•	•	•	•							•	
ARIMA	Mahogany		•	•	•													
	Fir																	
	Oak			•	•						•							
	Smooth	•	•	•	•						•			•				
	Steel	•	•	•	•			•	•	•			•	•				
AZUR	Mahogany		•	•	•													
	Fir																	
	Oak			•	•						•							
	Smooth	•	•	•	•						•			•				
	Steel	•	•	•	•			•	•	•			•	•				
BOLERO	Mahogany				•													
	Fir																	
	Oak				•													
	Smooth				•													
	Steel				•													
CACHET	Mahogany		•	•														
	Fir																	
	Oak			•		•												
	Smooth	•	•	•		•												
	Steel	•	•	•		•												
CELESTE	Mahogany		•	•	•													
	Fir																	
	Oak			•	•						•							
	Smooth	•	•	•	•						•			•				
	Steel	•	•	•	•			•	•	•			•	•				
CHANELLE	Mahogany		•	•	•													
	Fir																	
	Oak			•	•													
	Smooth	•	•	•	•													•
	Steel	•	•	•	•									•				•



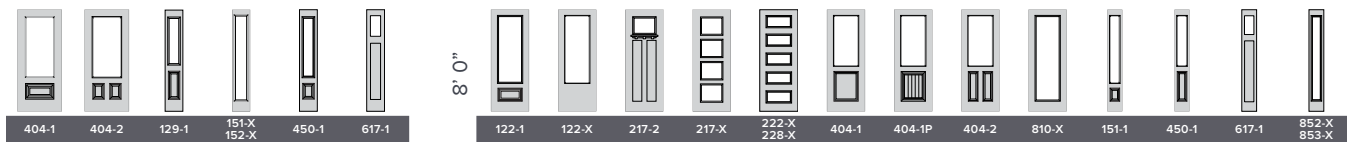



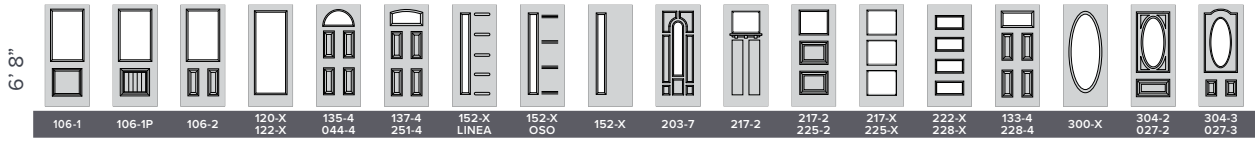

404-1	404-2	129-1	151-X	152-X	450-1	617-1	8' 0"	122-1	122-X	217-2	217-X	222-X	228-X	404-1	404-1P	404-2	810-X	151-1	450-1	617-1	852-X	853-X
•		•	•	•												•				•		
			•	•	•											•				•		
•		•	•	•	•									•	•	•				•		
•	•	•	•	•	•											•				•		
•		•	•	•	•											•				•		
			•	•	•											•				•		
•		•	•	•	•									•	•	•				•		
•		•	•	•	•			•								•				•		
			•	•	•			•		•				•	•	•				•		
•		•	•	•	•			•		•				•	•	•				•		
•	•	•	•	•	•				•							•				•		
•		•	•	•	•											•				•		
			•	•	•											•				•		
•		•	•	•	•											•				•		
•		•	•	•	•			•		•				•	•	•				•		
•	•	•	•	•	•				•							•				•		
•		•	•	•	•			•		•				•	•	•				•		
•	•	•	•	•	•				•							•				•		

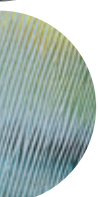
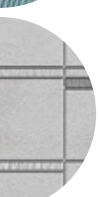
# STYLE MATRIX - DECORATIVE LITES

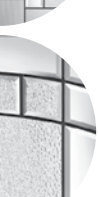

	106-1	106-1P	106-2	120-X 122-X	135-4 044-4	137-4 251-4	152-X LINEA	152-X OSO	152-X	203-7	217-2	217-2 225-2	217-X 225-X	222-X 228-X	133-4 228-4	300-X	304-2 027-2	304-3 027-3
 <b>CHELSEA®</b>	Mahogany		•	•	•													
	Fir																	
	Oak			•	•				•									
	Smooth	•	•	•	•				•									
	Steel	•	•	•	•		•	•	•									
 <b>CHORD®</b>	Mahogany		•	•	•												•	
	Fir										•							
	Oak			•	•				•					•	•			
	Smooth	•	•	•	•				•		•		•	•	•			
	Steel	•	•	•	•		•	•	•		•	•	•	•	•			
 <b>CROSSWALK</b>	Mahogany		•	•	•													
	Fir																	
	Oak			•	•				•									
	Smooth	•	•	•	•				•									
	Steel	•	•	•	•		•	•	•									
 <b>CRUZ™</b>	Mahogany		•	•	•													
	Fir																	
	Oak			•	•				•									
	Smooth	•	•	•	•				•									
	Steel	•	•	•	•		•	•	•									
 <b>CUZCO®</b>	Mahogany		•	•	•													
	Fir																	
	Oak			•	•				•									
	Smooth	•	•	•	•				•									
	Steel	•	•	•	•		•	•	•									
 <b>ELEMENT®</b>	Mahogany		•	•	•													
	Fir										•							
	Oak			•	•		•		•									
	Smooth	•	•	•	•		•		•		•		•					
	Steel	•	•	•	•		•	•	•		•	•	•					
 <b>ENTROPY</b>	Mahogany				•													
	Fir																	
	Oak				•													
	Smooth				•													
	Steel				•													
 <b>EQUATION</b>	Mahogany																	
	Fir																	
	Oak																	
	Smooth	•	•	•	•				•									
	Steel	•	•	•	•		•	•	•									



# STYLE MATRIX - DECORATIVE LITES

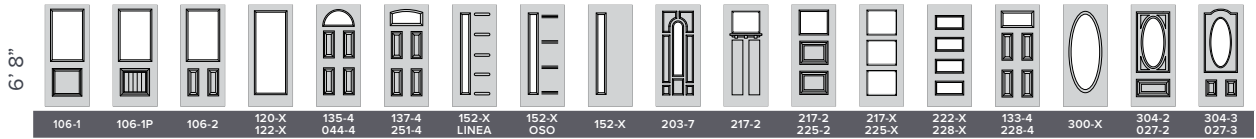

	106-1	106-1P	106-2	120-X 122-X	135-4 044-4	137-4 251-4	152-X LINEA	152-X OSO	152-X	203-7	217-2	217-2 225-2	217-X 225-X	222-X 228-X	133-4 228-4	300-X	304-2 027-2	304-3 027-3
FLUID	Mahogany		•	•	•													
	Fir																	
	Oak			•	•				•					•				
	Smooth	•	•	•	•				•				•	•				
	Steel	•	•	•	•		•	•	•			•	•	•				
FOCUS	Mahogany		•	•	•												•	
	Fir										•							
	Oak			•	•				•					•	•			
	Smooth	•	•	•	•				•		•		•	•	•			
	Steel	•	•	•	•		•	•	•		•	•	•	•	•			
FRONTIER®	Mahogany		•	•													•	
	Fir										•							
	Oak			•					•					•	•			
	Smooth	•	•	•					•		•		•	•	•			
	Steel	•	•	•			•	•	•		•	•	•	•	•			
GEORGIAN™	Mahogany		•	•	•													•
	Fir																	
	Oak			•	•				•									
	Smooth	•	•	•	•				•									•
	Steel	•	•	•	•		•	•	•									•
HARLOW	Mahogany		•	•	•													
	Fir																	
	Oak			•	•				•									
	Smooth	•	•	•	•				•									
	Steel	•	•	•	•		•	•	•									
HOLLISTER	Mahogany		•	•	•													
	Fir																	
	Oak			•	•				•									
	Smooth	•	•	•	•				•									
	Steel	•	•	•	•		•	•	•									
KORDELLA®	Mahogany		•	•	•													
	Fir																	
	Oak			•	•				•									
	Smooth	•	•	•	•				•									
	Steel	•	•	•	•		•	•	•									
LEXINGTON	Mahogany		•	•	•													
	Fir																	
	Oak			•	•				•				•	•				
	Smooth	•	•	•	•				•				•	•				
	Steel	•	•	•	•		•	•	•				•	•				

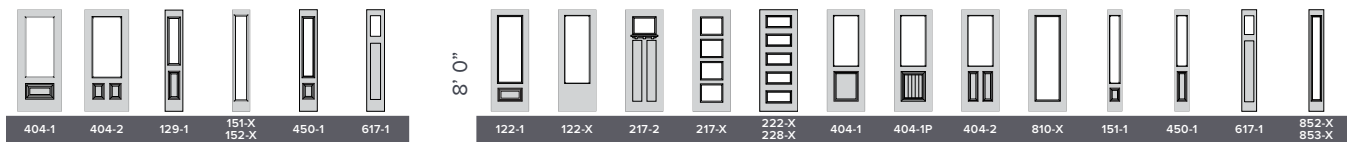

404-1	404-2	129-1	151-X	152-X	450-1	617-1	8' 0"	122-1	122-X	217-2	217-X	222-X	228-X	404-1	404-1P	404-2	810-X	151-1	450-1	617-1	852-X	853-X
•		•	•	•				•								•				•		
			•	•	•											•				•		
•		•	•	•	•			•			•	•	•	•	•	•				•		
•	•	•	•	•	•				•		•	•				•				•		
•			•					•								•		•	•			
			•													•		•	•			
•			•					•		•	•	•	•	•	•	•			•	•	•	
•	•		•						•		•	•				•		•	•		•	
•		•	•	•	•			•								•		•	•			
			•	•	•											•		•	•			
•		•	•	•	•			•								•		•	•			
•			•					•								•		•	•			
			•													•		•	•			
•		•	•	•	•			•								•		•	•			
•	•	•	•	•	•				•							•		•	•			
•			•					•								•		•	•			
			•	•	•											•		•	•			
•		•	•	•	•			•								•		•	•			
•	•	•	•	•	•				•							•		•	•			

# STYLE MATRIX - DECORATIVE LITES

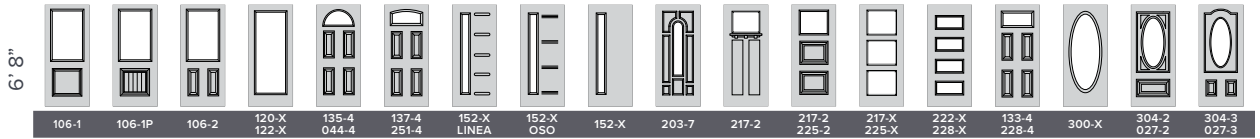

Style	106-1	106-1P	106-2	120-X 122-X	135-4 044-4	137-4 251-4	152-X LINEA	152-X OSO	152-X	203-7	217-2	217-2 225-2	217-X 225-X	222-X 228-X	133-4 228-4	300-X	304-2 027-2	304-3 027-3
<b>LOUISBOURG</b>	Mahogany		•	•	•													
	Fir																	
	Oak			•	•				•									
	Smooth	•	•	•	•				•									
	Steel	•	•	•	•		•	•	•									
<b>MARCO®</b>	Mahogany		•	•													•	
	Fir										•							
	Oak			•					•					•	•			
	Smooth	•	•	•					•		•		•	•	•			
	Steel	•	•	•			•	•	•		•	•	•	•	•			
<b>MISTIFY</b>	Mahogany		•	•	•													
	Fir																	
	Oak			•	•				•									
	Smooth	•	•	•	•				•									
	Steel	•	•	•	•		•	•	•									
<b>MISTRAL</b>	Mahogany		•	•	•													
	Fir																	
	Oak			•	•													
	Smooth	•	•	•	•								•					
	Steel	•	•	•	•							•	•					
<b>MODENA</b>	Mahogany		•	•	•													
	Fir																	
	Oak			•	•				•									
	Smooth	•	•	•	•				•									
	Steel	•	•	•	•		•	•	•									
<b>MONTEREY</b>	Mahogany		•	•	•													
	Fir																	
	Oak			•	•				•									
	Smooth	•	•	•	•				•									
	Steel	•	•	•	•		•	•	•									
<b>NAPLES®</b>	Mahogany		•	•	•					•							•	
	Fir										•							
	Oak			•	•				•					•	•			
	Smooth	•	•	•	•				•	•		•	•	•	•			
	Steel	•	•	•	•		•	•	•	•	•	•	•	•	•			
<b>NUANDO</b>	Mahogany				•													
	Fir																	
	Oak				•													
	Smooth				•													
	Steel				•													



# STYLE MATRIX - DECORATIVE LITES

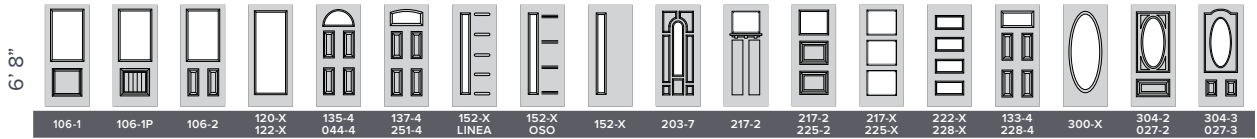

	106-1	106-1P	106-2	120-X 122-X	135-4 044-4	137-4 251-4	152-X LINEA	152-X OSO	152-X	203-7	217-2	217-2 225-2	217-X 225-X	222-X 228-X	133-4 228-4	300-X	304-2 027-2	304-3 027-3
OPAL	Mahogany		•	•	•													
	Fir																	
	Oak			•	•				•									
	Smooth	•	•	•	•				•									
	Steel	•	•	•	•			•	•	•								
PANAMA®	Mahogany		•	•	•						•							•
	Fir																	
	Oak			•	•	•			•									
	Smooth	•	•	•	•	•			•									•
	Steel	•	•	•	•	•		•	•	•	•							
PEAR	Mahogany		•	•	•													•
	Fir										•							
	Oak			•	•				•					•	•			
	Smooth	•	•	•	•				•		•		•	•	•			
	Steel	•	•	•	•			•	•	•	•	•	•	•	•	•		
PEARL®	Mahogany		•	•	•													•
	Fir										•							
	Oak			•	•				•					•	•			
	Smooth	•	•	•	•				•		•		•	•	•			
	Steel	•	•	•	•			•	•	•	•	•	•	•	•	•		
PURE	Mahogany				•													
	Fir																	
	Oak				•				•									
	Smooth				•				•									
	Steel				•			•	•	•								
ROYSTON	Mahogany		•	•	•													
	Fir																	
	Oak			•	•				•									
	Smooth	•	•	•	•				•									
	Steel	•	•	•	•			•	•	•								
ROZET™	Mahogany		•	•	•													•
	Fir																	
	Oak			•	•		•		•									
	Smooth	•	•	•	•		•		•									•
	Steel	•	•	•	•		•	•	•	•								
SOFT	Mahogany		•	•	•													
	Fir																	
	Oak			•	•				•						•			
	Smooth	•	•	•	•				•				•	•				
	Steel	•	•	•	•			•	•	•		•	•	•				





# STYLE MATRIX - DECORATIVE LITES

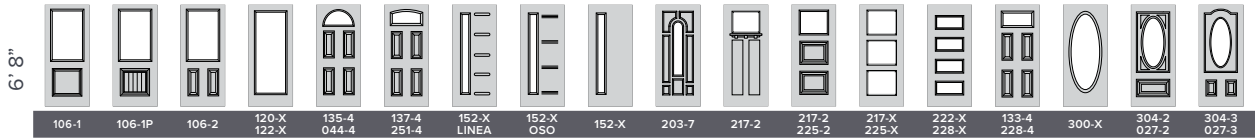

	106-1	106-1P	106-2	120-X 122-X	135-4 044-4	137-4 251-4	152-X LINEA	152-X OSO	152-X	203-7	217-2	217-2 225-2	217-X 225-X	222-X 228-X	133-4 228-4	300-X	304-2 027-2	304-3 027-3
<b>TEXTURE &amp; CLEAR</b>	Mahogany		•	•	•											•		•
	Fir										•							
	Oak			•	•	•	•		•					•	•	•		
	Smooth	•	•	•	•	•			•		•		•	•	•	•	•	
	Steel	•	•	•	•	•	•	•	•		•	•	•	•	•	•		•
<b>TRANSIT</b>	Mahogany		•	•	•												•	
	Fir																	
	Oak			•	•				•					•	•			
	Smooth	•	•	•	•				•				•	•	•			
	Steel	•	•	•	•		•	•	•			•	•	•	•			
<b>VENT &amp; BLINDS</b>	Mahogany		•	•	•													
	Fir																	
	Oak			•	•				•*									
	Smooth	•	•	•	•				•*									
	Steel	•	•	•	•		•*	•*	•*									
<b>VERSO</b>	Mahogany		•	•	•													
	Fir																	
	Oak			•	•				•									
	Smooth	•	•	•	•				•				•					
	Steel	•	•	•	•		•	•	•									
<b>WINCHESTER</b>	Mahogany		•	•	•													
	Fir																	
	Oak			•	•				•									
	Smooth	•	•	•	•				•				•					
	Steel	•	•	•	•		•	•	•			•	•					
<b>ZENITH</b>	Mahogany		•	•	•													
	Fir																	
	Oak			•	•				•									
	Smooth	•	•	•	•				•									
	Steel	•	•	•	•		•	•	•									

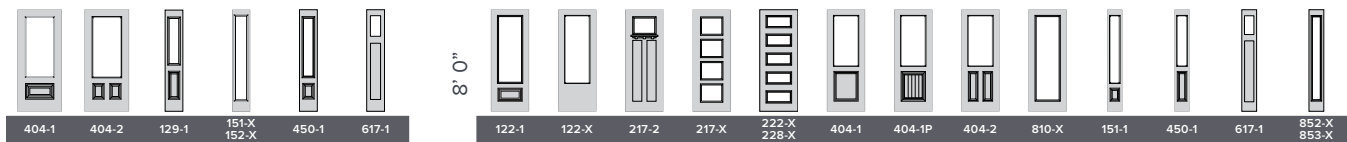

404-1	404-2	129-1	151-X 152-X	450-1	617-1	122-1	122-X	217-2	217-X	222-X 228-X	404-1	404-1P	404-2	810-X	151-1	450-1	617-1	852-X 853-X	
•		•	•	•		•							•	•	•	•		•	
					•														•
		•	•	•									•	•	•	•			•
•		•	•	•	•	•		•	•	•	•	•	•	•	•	•	•	•	•
•	•	•	•	•	•		•		•	•			•	•	•	•	•	•	•
•		•	•	•		•							•			•			
			•	•	•								•			•			
			•	•	•								•			•			
•			•	•	•	•			•	•	•	•	•			•			
			•*	•*															
			•*	•*															
			•*	•*												•*			
			•*	•*												•*			
•		•	•	•		•							•		•	•			
			•	•	•								•		•	•			
•		•	•	•	•	•					•	•	•		•	•			
•	•	•	•	•	•		•						•	•	•	•	•	•	•
•		•	•	•		•													
•		•	•	•		•							•		•	•			
			•	•	•								•		•	•			
•		•	•	•	•	•					•	•	•		•	•			
•	•	•	•	•	•		•						•	•	•	•	•	•	•

\*Not available as a venting lite. Available as an internal blind lite only.

# STYLE MATRIX - CRAFTSMAN SMOOTH

		6'8"					8'0"				
		1 Lite	3 Lite	6 Lite	1 Lite	2 Lite	1 Lite	3 Lite	6 Lite	1 Lite	2 Lite
CLEAR	Smooth	•			•						
	SDL		•	•		•		•	•	•	

# STYLE MATRIX - MID-CENTURY MODERN

		6'8"				8'0"			
		223	806	808	151	223	806	808	852
CROSS REED	Smooth	•	•	•	•	•	•	•	•
	Steel	•	•	•	•	•	•	•	•
NARROW REED	Smooth	•	•	•	•	•	•	•	•
	Steel	•	•	•	•	•	•	•	•
SABLE	Smooth	•	•	•	•	•	•	•	•
	Steel	•	•	•	•	•	•	•	•
SAND BLASTED	Smooth	•	•	•	•	•	•	•	•
	Steel	•	•	•	•	•	•	•	•
SEA SPRAY	Smooth	•	•	•	•	•	•	•	•
	Steel	•	•	•	•	•	•	•	•

# STYLE MATRIX - PANELS

6' 9"													
	1 Shaker	2 Shaker	2P Arch	2 Arch	1P Square	Flush	2 Hollister	2 Square	3 Arch	3 Equal	3 Craftsman	6	8
Barrington Sierra Mahogany			•										
Rustic Mahogany			•	•	•			•					
Contemporary Cherry (Grooved Lines)						•							
Contemporary Cherry (Steel Lines)													
Mahogany			•									•	•
Fir	•	•									•		
Oak						•						•	
Smooth	•	•	•			•		•			•	•	
Steel			•	•		•	•	•	•	•	•	•	•
Steel (Black Exterior)						•	•					•	

6' 8"												
	SOHO	VOG	OSO	Linea	C500	C501	C528	C536	C601	C602	C604	C605
Barrington Sierra Mahogany												
Rustic Mahogany												
Contemporary Cherry (Grooved Lines)					•	•	•	•				
Contemporary Cherry (Steel Lines)									•	•	•	•
Mahogany												
Fir												
Oak												
Smooth												
Steel	•	•	•	•								
Steel (Black Exterior)												

8' 0"										
	1 Shaker	2 Shaker	1P Arch	2P Arch	1P Square	Flush	2P Square	2 Square	3 Craftsman	6
Barrington Sierra Mahogany				•						
Rustic Mahogany			•	•	•		•			
Contemporary Cherry (Grooved Lines)						•				
Contemporary Cherry (Steel Lines)										
Mahogany										•
Fir	•	•								
Oak						•				•
Smooth	•	•		•		•		•		•
Steel						•				•
Steel (Black Exterior)										

8' 0"										
	SOHO	VOG	C500	C501	C528	C536	C608	C609	C611	C612
Barrington Sierra Mahogany										
Rustic Mahogany										
Contemporary Cherry (Grooved Lines)			•	•	•	•				
Contemporary Cherry (Steel Lines)							•	•	•	•
Mahogany										
Fir										
Oak										
Smooth										
Steel	•	•								
Steel (Black Exterior)										

# STYLE MATRIX - VISTAGRANDE™

	6' 8"								8' 0"							
	120 122 926	120 122 926	426	426 926	152	152	450	450	810 820 826	810 820 826	926	926	852	852	151	151
CHORD®	Smooth	•	•	•	•	•	•	•	•	•	•	•	•	•	•	•
	Fir	•	•	•	•	•	•	•	•	•	•	•	•	•	•	•
CLEAR	Smooth	•	•	•	•	•	•	•	•	•	•	•	•	•	•	•
	Fir	•	•	•	•	•	•	•	•	•	•	•	•	•	•	•
MINI BLINDS	Smooth	•				•			•		•		•		•	
	Fir	•				•			•		•		•		•	
PEARL	Smooth	•	•	•	•	•	•	•	•	•	•	•	•	•	•	•
	Fir	•	•	•	•	•	•	•	•	•	•	•	•	•	•	•
PEARL®	Smooth	•	•	•	•	•	•	•	•	•	•	•	•	•	•	•
	Fir	•	•	•	•	•	•	•	•	•	•	•	•	•	•	•

## VISTAGRANDE™ SDL



3-1/2" 4 lite\*



3-1/2" 3 lite\*



1-1/8" 3 lite ladder\*



1-1/8" 3 lite ladder\*



1-1/8" 6 lite rectangular\*



1-1/8" 10 lite rectangular\*



1-1/8" 4 lite rectangular\*



1-1/8" 6 lite rectangular\*

\*Availability may vary. Not all options shown. 1-1/8" SDL is only available with clear glass. 3-1/2" SDL is available as indicated in the matrix above. Rectangular patterns are available from 2-12 lites depending on lite and slab size. Please ask an All Weather Windows customer service or sales representative for all available options.

# SLAB SIZING

## BARRINGTON® SIERRA® MAHOGANY TEXTURE



	2P BSP
6'8"	3'0"
8'0"	3'0", 3'6"

## CONTEMPORARY CHERRY TEXTURE

STAINLESS  
STEEL LINES

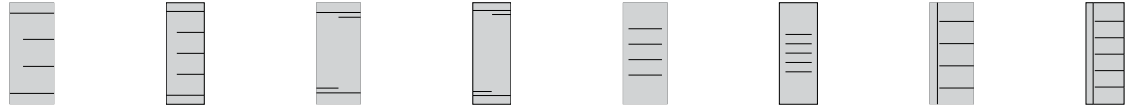

	C601	C608	C602	C609	C604	C611	C605	C612
6'8"	2'10", 3'0", 3'6"		2'10", 3'0", 3'6"		2'10", 3'0", 3'6"		2'10", 3'0", 3'6"	
8'0"		2'10", 3'0", 3'6"		2'10", 3'0", 3'6"		2'10", 3'0", 3'6"		2'10", 3'0", 3'6"

GROOVED  
LINES

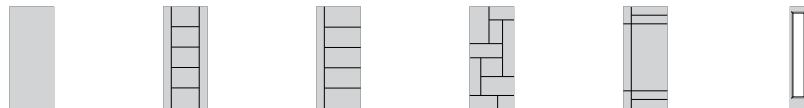

	C499	C500	C501	C528	C536	C498
6'8"	2'8", 2'10", 3'0", 3'6"	2'8", 2'10", 3'0", 3'6"	2'8", 2'10", 3'0", 3'6"	2'10", 3'0"	2'8", 2'10", 3'0", 3'6"	1'0", 1'2"
8'0"	2'8", 2'10", 3'0", 3'6"	2'8", 2'10", 3'0", 3'6"	2'8", 2'10", 3'0", 3'6"	2'10", 3'0", 3'6"	2'8", 2'10", 3'0", 3'6"	1'0", 1'2"
Lite Sizes	151, 152, 852					151, 152, 852

## CRAFTSMAN SMOOTH



	2 Panel Smooth Craftsman	1 Panel Smooth Craftsman Sidelite
6'8"	3'0"	1'0"
8'0"	3'0"	1'0"
Lite Sizes	217	152

## FIR TEXTURE

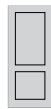

	1 Shaker	2 Shaker	3 Craftsman	Craftsman Sidelite
6'8"	2'8", 2'10", 3'0"	2'8", 2'10", 3'0"	2'8", 2'10", 3'0"	1'0", 1'2"
8'0"	2'8", 2'10", 3'0"	2'8", 2'10", 3'0"	2'8", 2'10", 3'0"	
Lite Sizes			217	617



## MAHOGANY TEXTURE





	2 Hollister Oval	2P Arch	6	8	Half Sidelite	Full Sidelite	3/4 Sidelite
6'8"	2'8", 2'10", 3'0"	2'8", 2'10", 3'0"	2'8", 2'10", 3'0"	2'10", 3'0"	1'0", 1'2"	1'0", 1'2"	1'0", 1'2"
8'0"	2'8", 2'10", 3'0"		2'8", 2'10", 3'0", 3'6"		1'0", 1'2"	1'0", 1'2"	1'0", 1'2"
Lite Sizes	122, 304, 306, 404	106, 107	106, 122, 228, 404, 810	203	129, 450	151, 152, 852	151, 450

# SLAB SIZING







## OAK TEXTURE

			
	Flush	4 Blank Top	6
6'8"	2'0", 2'6", 2'8", 2'10", 3'0", 3'6"	2'8", 2'10", 3'0"	2'6", 2'8", 2'10", 3'0"
8'0"	2'6", 2'8", 2'10", 3'0", 3'6"		2'6", 2'8", 2'10", 3'0"
Lite Sizes	120, 122, 152, 810	106, 107, 135, 137, 228	106, 120, 122, 228, 404, 810







  

			
	1/2 Sidelite	Full Sidelite	3/4 Sidelite
6'8"	1'0", 1'2"	1'0", 1'2"	1'0", 1'2"
8'0"	1'0", 1'2"	1'0", 1'2"	1'0", 1'2"
Lite Sizes	129, 450	151, 152, 852	151, 450







## RUSTIC MAHOGANY TEXTURE

							
	1P Square	1P Arch	2P Arch	2P Square	2 Square	2 Arch	Full Lite Sidelite
6'8"	3'0"		3'0"		3'0"	3'0", 3'6"	1'0"
8'0"	3'0", 3'6"	3'0", 3'6"	3'0", 3'6"	3'0", 3'6"			1'0"
Lite Sizes							152







## SMOOTH FIBREGLASS

						
	Flush	1 Shaker	2 Shaker	2 Square	2 Hollister Oval	2P Arch
6'8"	2'0", 2'6", 2'8", 2'10", 3'0", 3'6"	2'8", 2'10", 3'0"	2'8", 2'10", 3'0"	2'8", 2'10", 3'0"	2'8", 2'10", 3'0"	2'8", 2'10", 3'0"
8'0"	2'0", 2'6", 2'8", 2'10", 3'0", 3'6"	2'8", 2'10", 3'0"	2'8", 2'10", 3'0"	2'8", 2'10", 3'0"	2'8", 2'10", 3'0"	2'8", 2'10", 3'0"
Lite Sizes	120, 122, 152, 300, 810			106	122, 304, 306, 404	106, 107, 404

						
	3 Craftsman	4 Blank Top	6	680	680	682
6'8"	2'8", 2'10", 3'0"	2'8", 2'10", 3'0"	2'6", 2'8", 2'10", 3'0"	2'8", 2'10", 3'0"		2'8", 2'10", 3'0"
8'0"	2'8", 2'10", 3'0", 3'6"		2'6", 2'8", 2'10", 3'0"		2'8", 2'10", 3'0"	2'8", 2'10", 3'0"
Lite Sizes	217	106, 107, 135, 137, 228	106, 120, 122, 228, 404, 810	680	680	682









  

						
	223	223	1/2 Lite Sidelite	Full Lite Sidelite	3/4 Lite Sidelite	Craftsman Sidelite
6'8"	2'8", 2'10", 3'0"		1'0", 1'2"	1'0", 1'2"	1'0", 1'2"	1'0", 1'2"
8'0"		2'8", 2'10", 3'0"	1'0", 1'2"	1'0", 1'2"	1'0", 1'2"	1'0", 1'2"
Lite Sizes	223	223	129, 450	151, 152, 852	151, 450	615









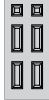

# SLAB SIZING







## STEEL

								
	Flush	2 Square	2 Arch	2P Arch	2 Hollister	3 Craftsman	3 Equal	3 Arch
6'8"	2'0", 2'6", 2'8", 2'10", 3'0"	2'8", 2'10", 3'0"	2'8", 2'10", 3'0"	2'8", 2'10", 3'0"	2'8", 2'10", 3'0"	2'8", 2'10", 3'0"	2'8", 2'10", 3'0"	2'8", 2'10", 3'0"
8'0"	2'6", 2'8", 2'10", 3'0"							
Lite Sizes	120, 122, 152, 300, 810	106	106, 107	106, 107	404	217	217	304, 404



  

								
	6	8	680	680	223	223	682	Linea
6'8"	2'6", 2'8", 2'10", 3'0"	2'8", 2'10", 3'0"	2'8", 2'10", 3'0"		2'8", 2'10", 3'0"		2'8", 2'10", 3'0"	2'8", 2'10", 3'0"
8'0"	2'8", 2'10", 3'0"			2'8", 2'10", 3'0"		2'8", 2'10", 3'0"	2'8", 2'10", 3'0"	
Lite Sizes	106, 120, 122, 404, 810	203	680	680	223	223	682	152



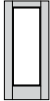

							
	Oso	Soho	Vog	1/2 Lite Sidelite	Full Lite Sidelite	3/4 Lite Sidelite	Craftsman Sidelite
6'8"	2'10", 3'0"	2'8", 2'10", 3'0"	2'10", 3'0"	1'0", 1'2"	1'0", 1'2"	1'0", 1'2"	1'0", 1'2"
8'0"		2'8", 2'10", 3'0"	2'10", 3'0"	1'0", 1'2"	1'0", 1'2"	1'0", 1'2"	
Lite Sizes	152			129, 450	151, 152, 852	151, 450	615

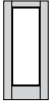
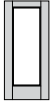
## VISTAGRANDE™ SMOOTH & FIR TEXTURE

				
	Full Lite	Full Lite	Full Lite	Full Lite
6'8"	2'6"	2'8"	2'10"	3'0"
8'0"	2'6"	2'8"	2'10"	3'0"
Lite Sizes	120, 820	122, 810	122, 810	926, 826

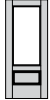
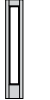
			
	3/4 Lite	Full Lite Sidelite	3/4 Lite Sidelite
6'8"	3'0"	1'0", 1'2"	1'0", 1'2"
8'0"	3'0"	1'0", 1'2"	1'0", 1'2"
Lite Sizes	426, 926	152, 852	450, 151

# ROUGH OPENINGS

## SINGLE DOORS

DOOR SIZE		OVERALL DOOR UNIT SIZE (OSM)			ROUGH OPENING (RO)			2" RENO BRICKMOULD (OSBM)			2" WOOD BRICKMOULD (OSBM)		
Width	Height	Width	Height		Width	Height		Width	Height		Width	Height	
			Inswing	Outswing		Inswing	Outswing		Inswing	Outswing		Inswing	Outswing
2'0"	6'8"	25-9/16"	81-5/8"	81-3/8"	26-9/16"	82-1/8"	81-7/8"	28-1/2"	83-1/8"	82-7/8"	28"	82-7/8"	82-5/8"
2'0"	8'0"	25-9/16"	97-5/8"	97-3/8"	26-9/16"	98-1/8"	97-7/8"	28-1/2"	99-1/8"	98-7/8"	28"	98-7/8"	98-5/8"
2'6"	6'8"	31-9/16"	81-5/8"	81-3/8"	32-9/16"	82-1/8"	81-7/8"	34-1/2"	83-1/8"	82-7/8"	34"	82-7/8"	82-5/8"
2'6"	8'0"	31-9/16"	97-5/8"	97-3/8"	32-9/16"	98-1/8"	97-7/8"	34-1/2"	99-1/8"	98-7/8"	34"	98-7/8"	98-5/8"
2'8"	6'8"	33-9/16"	81-5/8"	81-3/8"	34-9/16"	82-1/8"	81-7/8"	36-1/2"	83-1/8"	82-7/8"	36"	82-7/8"	82-5/8"
2'8"	8'0"	33-9/16"	97-5/8"	97-3/8"	34-9/16"	98-1/8"	97-7/8"	36-1/2"	99-1/8"	98-7/8"	36"	98-7/8"	98-5/8"
2'10"	6'8"	35-9/16"	81-5/8"	81-3/8"	36-9/16"	82-1/8"	81-7/8"	38-1/2"	83-1/8"	82-7/8"	38"	82-7/8"	82-5/8"
2'10"	8'0"	35-9/16"	97-5/8"	97-3/8"	36-9/16"	98-1/8"	97-7/8"	38-1/2"	99-1/8"	98-7/8"	38"	98-7/8"	98-5/8"
3'0"	6'8"	37-9/16"	81-5/8"	81-3/8"	38-9/16"	82-1/8"	81-7/8"	40-1/2"	83-1/8"	82-7/8"	40"	82-7/8"	82-5/8"
3'0"	8'0"	37-9/16"	97-5/8"	97-3/8"	38-9/16"	98-1/8"	97-7/8"	40-1/2"	99-1/8"	98-7/8"	40"	98-7/8"	98-5/8"
3'6"	6'8"	43-9/16"	81-5/8"	81-3/8"	44-9/16"	82-1/8"	81-7/8"	46-1/2"	83-1/8"	82-7/8"	46"	82-7/8"	82-5/8"
3'6"	8'0"	43-9/16"	97-5/8"	97-3/8"	44-9/16"	98-1/8"	97-7/8"	46-1/2"	99-1/8"	98-7/8"	46"	98-7/8"	98-5/8"

## DOUBLE DOORS

DOOR SIZE		OVERALL DOOR UNIT SIZE (OSM)			ROUGH OPENING (RO)			2" RENO BRICKMOULD (OSBM)			2" WOOD BRICKMOULD (OSBM)		
Width	Height	Width	Height		Width	Height		Width	Height		Width	Height	
			Inswing	Outswing		Inswing	Outswing		Inswing	Outswing		Inswing	Outswing
2'0"	6'8"	50-3/8"	81-5/8"	81-3/8"	51-3/8"	82-1/8"	81-7/8"	53-5/16"	83-1/8"	82-7/8"	52-7/8"	82-7/8"	82-5/8"
2'0"	8'0"	50-3/8"	97-5/8"	97-3/8"	51-3/8"	98-1/8"	97-7/8"	53-5/16"	99-1/8"	98-7/8"	52-7/8"	98-7/8"	98-5/8"
2'6"	6'8"	62-3/8"	81-5/8"	81-3/8"	63-3/8"	82-1/8"	81-7/8"	65-5/16"	83-1/8"	82-7/8"	64-7/8"	82-7/8"	82-5/8"
2'6"	8'0"	62-3/8"	97-5/8"	97-3/8"	63-3/8"	98-1/8"	97-7/8"	65-5/16"	99-1/8"	98-7/8"	64-7/8"	98-7/8"	98-5/8"
2'8"	6'8"	66-3/8"	81-5/8"	81-3/8"	67-3/8"	82-1/8"	81-7/8"	69-5/16"	83-1/8"	82-7/8"	68-7/8"	82-7/8"	82-5/8"
2'8"	8'0"	66-3/8"	97-5/8"	97-3/8"	67-3/8"	98-1/8"	97-7/8"	69-5/16"	99-1/8"	98-7/8"	68-7/8"	98-7/8"	98-5/8"
2'10"	6'8"	70-3/8"	81-5/8"	81-3/8"	71-3/8"	82-1/8"	81-7/8"	73-5/16"	83-1/8"	82-7/8"	72-7/8"	82-7/8"	82-5/8"
2'10"	8'0"	70-3/8"	97-5/8"	97-3/8"	71-3/8"	98-1/8"	97-7/8"	73-5/16"	99-1/8"	98-7/8"	72-7/8"	98-7/8"	98-5/8"
3'0"	6'8"	74-3/8"	81-5/8"	81-3/8"	75-3/8"	82-1/8"	81-7/8"	77-5/16"	83-1/8"	82-7/8"	76-7/8"	82-7/8"	82-5/8"
3'0"	8'0"	74-3/8"	97-5/8"	97-3/8"	75-3/8"	98-1/8"	97-7/8"	77-5/16"	99-1/8"	98-7/8"	76-7/8"	98-7/8"	98-5/8"
3'6"	6'8"	86-3/8"	81-5/8"	81-3/8"	87-3/8"	82-1/8"	81-7/8"	89-5/16"	83-1/8"	82-7/8"	88-7/8"	82-7/8"	82-5/8"
3'6"	8'0"	86-3/8"	97-5/8"	97-3/8"	87-3/8"	98-1/8"	97-7/8"	89-5/16"	99-1/8"	98-7/8"	88-7/8"	98-7/8"	98-5/8"

## GARDEN & RENOVATION GARDEN DOORS

DOOR SIZE		OVERALL DOOR UNIT SIZE (OSM)			ROUGH OPENING (RO)			2" RENO BRICKMOULD (OSBM)			2" WOOD BRICKMOULD (OSBM)		
Width	Height	Width	Height		Width	Height		Width	Height		Width	Height	
			Inswing	Outswing		Inswing	Outswing		Inswing	Outswing		Inswing	Outswing
2'4"	6'7"	59-3/8"	-	79-3/8"	60-3/8"	-	79-7/8"	62-5/16"	-	80-7/8"	61-13/16"	-	80-5/8"
2'6"	6'8"	63-3/8"	81-5/8"	81-3/8"	64-3/8"	82-1/8"	81-7/8"	66-5/16"	83-1/8"	82-7/8"	65-7/8"	82-7/8"	82-5/8"
2'6"	8'0"	63-3/8"	97-5/8"	81-3/8"	64-3/8"	98-1/8"	97-7/8"	66-5/16"	99-1/8"	98-7/8"	65-7/8"	98-7/8"	98-5/8"
2'8"	6'8"	67-3/8"	81-5/8"	81-3/8"	68-3/8"	82-1/8"	81-7/8"	70-5/16"	83-1/8"	82-7/8"	69-7/8"	82-7/8"	82-5/8"
2'8"	8'0"	67-3/8"	97-5/8"	97-3/8"	68-3/8"	98-1/8"	97-7/8"	70-5/16"	99-1/8"	98-7/8"	69-7/8"	98-7/8"	98-5/8"
2'10"	6'7"	71-3/8"	-	79-3/8"	72-3/8"	-	79-7/8"	74-5/16"	-	80-7/8"	73-13/16"	-	80-5/8"
2'10"	6'8"	71-3/8"	81-5/8"	81-3/8"	72-3/8"	82-1/8"	81-7/8"	74-5/16"	83-1/8"	82-7/8"	73-7/8"	82-7/8"	82-5/8"
2'10"	8'0"	71-3/8"	97-5/8"	97-3/8"	72-3/8"	98-1/8"	97-7/8"	74-5/16"	99-1/8"	98-7/8"	73-7/8"	98-7/8"	98-5/8"
3'0"	6'8"	75-3/8"	81-5/8"	81-3/8"	76-3/8"	82-1/8"	81-7/8"	78-5/16"	83-1/8"	82-7/8"	77-7/8"	82-7/8"	82-5/8"
3'0"	8'0"	75-3/8"	97-5/8"	97-3/8"	76-3/8"	98-1/8"	97-7/8"	78-5/16"	99-1/8"	98-7/8"	77-7/8"	98-7/8"	98-5/8"

Note: All dimensions shown here are for planning/estimation purposes only. Rough opening sizes shown are recommendations only and actual rough openings in your home may vary. Depending on the configuration and product selection, rough opening dimensions may be different. Floor coverings can affect rough opening heights. Always verify final door unit dimensions on your All Weather Windows quote.

# ROUGH OPENINGS

## SINGLE DOORS WITH ONE SIDELITE

DOOR SIZE		SIDELITE SIZE		OVERALL DOOR UNIT SIZE (OSM)			ROUGH OPENING (RO)			2" RENO BRICKMOULD (OSBM)			2" WOOD BRICKMOULD (OSBM)		
Width	Height	Width	Height	Width	Height		Width	Height		Width	Height		Width	Height	
					Inswing	Outswing		Inswing	Outswing		Inswing	Outswing		Inswing	Outswing
2'0"	6'8"	10"	6'8"	39-1/2"	81-5/8"	81-3/8"	40-1/2"	82-1/8"	81-7/8"	42-7/16"	83-1/8"	82-7/8"	42"	82-7/8"	82-5/8"
2'0"	6'8"	12"	6'8"	41-1/2"	81-5/8"	81-3/8"	42-1/2"	82-1/8"	81-7/8"	44-7/16"	83-1/8"	82-7/8"	44"	82-7/8"	82-5/8"
2'0"	8'0"	10"	8'0"	39-1/2"	97-5/8"	97-3/8"	40-1/2"	98-1/8"	97-7/8"	42-7/16"	99-1/8"	98-7/8"	42"	98-7/8"	98-5/8"
2'0"	8'0"	12"	8'0"	41-1/2"	97-5/8"	97-3/8"	42-1/2"	98-1/8"	97-7/8"	44-7/16"	99-1/8"	98-7/8"	44"	98-7/8"	98-5/8"
2'6"	6'8"	10"	6'8"	45-1/2"	81-5/8"	81-3/8"	46-1/2"	82-1/8"	81-7/8"	48-7/16"	83-1/8"	82-7/8"	48"	82-7/8"	82-5/8"
2'6"	6'8"	12"	6'8"	47-1/2"	81-5/8"	81-3/8"	48-1/2"	82-1/8"	81-7/8"	50-7/16"	83-1/8"	82-7/8"	50"	82-7/8"	82-5/8"
2'6"	8'0"	10"	8'0"	45-1/2"	97-5/8"	97-3/8"	46-1/2"	98-1/8"	97-7/8"	48-7/16"	99-1/8"	98-7/8"	48"	98-7/8"	98-5/8"
2'6"	8'0"	12"	8'0"	47-1/2"	97-5/8"	97-3/8"	48-1/2"	98-1/8"	97-7/8"	50-7/16"	99-1/8"	98-7/8"	50"	98-7/8"	98-5/8"
2'8"	6'8"	10"	6'8"	47-1/2"	81-5/8"	81-3/8"	48-1/2"	82-1/8"	81-7/8"	50-7/16"	83-1/8"	82-7/8"	50"	82-7/8"	82-5/8"
2'8"	6'8"	12"	6'8"	49-1/2"	81-5/8"	81-3/8"	50-1/2"	82-1/8"	81-7/8"	52-7/16"	83-1/8"	82-7/8"	52"	82-7/8"	82-5/8"
2'8"	8'0"	10"	8'0"	47-1/2"	97-5/8"	97-3/8"	48-1/2"	98-1/8"	97-7/8"	50-7/16"	99-1/8"	98-7/8"	50"	98-7/8"	98-5/8"
2'8"	8'0"	12"	8'0"	49-1/2"	97-5/8"	97-3/8"	50-1/2"	98-1/8"	97-7/8"	52-7/16"	99-1/8"	98-7/8"	52"	98-7/8"	98-5/8"
2'10"	6'8"	10"	6'8"	49-1/2"	81-5/8"	81-3/8"	50-1/2"	82-1/8"	81-7/8"	52-7/16"	83-1/8"	82-7/8"	52"	82-7/8"	82-5/8"
2'10"	6'8"	12"	6'8"	51-1/2"	81-5/8"	81-3/8"	52-1/2"	82-1/8"	81-7/8"	54-7/16"	83-1/8"	82-7/8"	54"	82-7/8"	82-5/8"
2'10"	8'0"	10"	8'0"	49-1/2"	97-5/8"	97-3/8"	50-1/2"	98-1/8"	97-7/8"	52-7/16"	99-1/8"	98-7/8"	52"	98-7/8"	98-5/8"
2'10"	8'0"	12"	8'0"	51-1/2"	97-5/8"	97-3/8"	52-1/2"	98-1/8"	97-7/8"	54-7/16"	99-1/8"	98-7/8"	54"	98-7/8"	98-5/8"
3'0"	6'8"	10"	6'8"	51-1/2"	81-5/8"	81-3/8"	52-1/2"	82-1/8"	81-7/8"	54-7/16"	83-1/8"	82-7/8"	54"	82-7/8"	82-5/8"
3'0"	6'8"	12"	6'8"	53-1/2"	81-5/8"	81-3/8"	54-1/2"	82-1/8"	81-7/8"	56-7/16"	83-1/8"	82-7/8"	56"	82-7/8"	82-5/8"
3'0"	8'0"	10"	8'0"	51-1/2"	97-5/8"	97-3/8"	52-1/2"	98-1/8"	97-7/8"	54-7/16"	99-1/8"	98-7/8"	54"	98-7/8"	98-5/8"
3'0"	8'0"	12"	8'0"	53-1/2"	97-5/8"	97-3/8"	54-1/2"	98-1/8"	97-7/8"	56-7/16"	99-1/8"	98-7/8"	56"	98-7/8"	98-5/8"
3'6"	6'8"	10"	6'8"	57-1/2"	81-5/8"	81-3/8"	58-1/2"	82-1/8"	81-7/8"	60-7/16"	83-1/8"	82-7/8"	60"	82-7/8"	82-5/8"
3'6"	6'8"	12"	6'8"	59-1/2"	81-5/8"	81-3/8"	60-1/2"	82-1/8"	81-7/8"	62-7/16"	83-1/8"	82-7/8"	62"	82-7/8"	82-5/8"
3'6"	8'0"	10"	8'0"	57-1/2"	97-5/8"	97-3/8"	58-1/2"	98-1/8"	97-7/8"	60-7/16"	99-1/8"	98-7/8"	60"	98-7/8"	98-5/8"
3'6"	8'0"	12"	8'0"	59-1/2"	97-5/8"	97-3/8"	60-1/2"	98-1/8"	97-7/8"	62-7/16"	99-1/8"	98-7/8"	62"	98-7/8"	98-5/8"

## SINGLE DOORS WITH TWO SIDELITES

DOOR SIZE		SIDELITE SIZE		OVERALL DOOR UNIT SIZE (OSM)			ROUGH OPENING (RO)			2" RENO BRICKMOULD (OSBM)			2" WOOD BRICKMOULD (OSBM)		
Width	Height	Width	Height	Width	Height		Width	Height		Width	Height		Width	Height	
					Inswing	Outswing		Inswing	Outswing		Inswing	Outswing		Inswing	Outswing
2'0"	6'8"	10"	6'8"	53-7/16"	81-5/8"	81-3/8"	54-7/16"	82-1/8"	81-7/8"	56-3/8"	83-1/8"	82-7/8"	55-7/8"	82-7/8"	82-5/8"
2'0"	6'8"	12"	6'8"	57-7/16"	81-5/8"	81-3/8"	58-7/16"	82-1/8"	81-7/8"	60-3/8"	83-1/8"	82-7/8"	59-7/8"	82-7/8"	82-5/8"
2'0"	8'0"	10"	8'0"	53-7/16"	97-5/8"	97-3/8"	54-7/16"	98-1/8"	97-7/8"	56-3/8"	99-1/8"	98-7/8"	55-7/8"	98-7/8"	98-5/8"
2'0"	8'0"	12"	8'0"	57-7/16"	97-5/8"	97-3/8"	58-7/16"	98-1/8"	97-7/8"	60-3/8"	99-1/8"	98-7/8"	59-7/8"	98-7/8"	98-5/8"
2'6"	6'8"	10"	6'8"	59-7/16"	81-5/8"	81-3/8"	60-7/16"	82-1/8"	81-7/8"	62-3/8"	83-1/8"	82-7/8"	61-7/8"	82-7/8"	82-5/8"
2'6"	6'8"	12"	6'8"	63-7/16"	81-5/8"	81-3/8"	64-7/16"	82-1/8"	81-7/8"	66-3/8"	83-1/8"	82-7/8"	65-7/8"	82-7/8"	82-5/8"
2'6"	8'0"	10"	8'0"	59-7/16"	97-5/8"	97-3/8"	60-7/16"	98-1/8"	97-7/8"	62-3/8"	99-1/8"	98-7/8"	61-7/8"	98-7/8"	98-5/8"
2'6"	8'0"	12"	8'0"	63-7/16"	97-5/8"	97-3/8"	64-7/16"	98-1/8"	97-7/8"	66-3/8"	99-1/8"	98-7/8"	65-7/8"	98-7/8"	98-5/8"
2'8"	6'8"	10"	6'8"	61-7/16"	81-5/8"	81-3/8"	62-7/16"	82-1/8"	81-7/8"	64-3/8"	83-1/8"	82-7/8"	63-7/8"	82-7/8"	82-5/8"
2'8"	6'8"	12"	6'8"	65-7/16"	81-5/8"	81-3/8"	66-7/16"	82-1/8"	81-7/8"	68-3/8"	83-1/8"	82-7/8"	67-7/8"	82-7/8"	82-5/8"
2'8"	8'0"	10"	8'0"	61-7/16"	97-5/8"	97-3/8"	62-7/16"	98-1/8"	97-7/8"	64-3/8"	99-1/8"	98-7/8"	63-7/8"	98-7/8"	98-5/8"
2'8"	8'0"	12"	8'0"	65-7/16"	97-5/8"	97-3/8"	66-7/16"	98-1/8"	97-7/8"	68-3/8"	99-1/8"	98-7/8"	67-7/8"	98-7/8"	98-5/8"
2'10"	6'8"	10"	6'8"	63-7/16"	81-5/8"	81-3/8"	64-7/16"	82-1/8"	81-7/8"	66-3/8"	83-1/8"	82-7/8"	65-7/8"	82-7/8"	82-5/8"
2'10"	6'8"	12"	6'8"	67-7/16"	81-5/8"	81-3/8"	68-7/16"	82-1/8"	81-7/8"	70-3/8"	83-1/8"	82-7/8"	69-7/8"	82-7/8"	82-5/8"
2'10"	8'0"	10"	8'0"	63-7/16"	97-5/8"	97-3/8"	64-7/16"	98-1/8"	97-7/8"	66-3/8"	99-1/8"	98-7/8"	65-7/8"	98-7/8"	98-5/8"
2'10"	8'0"	12"	8'0"	67-7/16"	97-5/8"	97-3/8"	68-7/16"	98-1/8"	97-7/8"	70-3/8"	99-1/8"	98-7/8"	69-7/8"	98-7/8"	98-5/8"
3'0"	6'8"	10"	6'8"	65-7/16"	81-5/8"	81-3/8"	66-7/16"	82-1/8"	81-7/8"	68-3/8"	83-1/8"	82-7/8"	67-7/8"	82-7/8"	82-5/8"
3'0"	6'8"	12"	6'8"	69-7/16"	81-5/8"	81-3/8"	70-7/16"	82-1/8"	81-7/8"	72-3/8"	83-1/8"	82-7/8"	71-7/8"	82-7/8"	82-5/8"
3'0"	8'0"	10"	8'0"	65-7/16"	97-5/8"	97-3/8"	66-7/16"	98-1/8"	97-7/8"	68-3/8"	99-1/8"	98-7/8"	67-7/8"	98-7/8"	98-5/8"
3'0"	8'0"	12"	8'0"	69-7/16"	97-5/8"	97-3/8"	70-7/16"	98-1/8"	97-7/8"	72-3/8"	99-1/8"	98-7/8"	71-7/8"	98-7/8"	98-5/8"
3'6"	6'8"	10"	6'8"	71-7/16"	81-5/8"	81-3/8"	72-7/16"	82-1/8"	81-7/8"	74-3/8"	83-1/8"	82-7/8"	73-7/8"	82-7/8"	82-5/8"
3'6"	6'8"	12"	6'8"	75-7/16"	81-5/8"	81-3/8"	76-7/16"	82-1/8"	81-7/8"	78-3/8"	83-1/8"	82-7/8"	77-7/8"	82-7/8"	82-5/8"
3'6"	8'0"	10"	8'0"	71-7/16"	97-5/8"	97-3/8"	72-7/16"	98-1/8"	97-7/8"	74-3/8"	99-1/8"	98-7/8"	73-7/8"	98-7/8"	98-5/8"
3'6"	8'0"	12"	8'0"	75-7/16"	97-5/8"	97-3/8"	76-7/16"	98-1/8"	97-7/8"	78-3/8"	99-1/8"	98-7/8"	77-7/8"	98-7/8"	98-5/8"

Note: All dimensions shown here are for planning/estimation purposes only. Rough opening sizes shown are recommendations only and actual rough openings in your home may vary. Depending on the configuration and product selection, rough opening dimensions may be different. Floor coverings can affect rough opening heights. Always verify final door unit dimensions on your All Weather Windows quote.

# MEASURING YOUR DOOR

## STEP 1

### MEASURE YOUR DOOR SLAB WIDTH

This is the measurement from the left edge of your door slab, straight across to the right edge (A).

## STEP 2

### MEASURE YOUR DOOR SLAB HEIGHT

This is the measurement from the top edge of your door slab, straight down to the very bottom, excluding the door sweep (B).

## STEP 3

### DETERMINE YOUR DOOR FRAME JAMB DEPTH

Your door jamb is the overall depth of your door frame which transitions from the exterior of your home to the interior and meets up with your casing. This measurement usually includes the exterior sheathing, stud and drywall thicknesses. This measurement is not always easy to determine, so do not worry if you cannot get an exact measurement. A qualified installer can help.



## STEP 4

### DETERMINE THE HANDING AND SWING

Using the diagrams below, determine and select the swing and handing of your existing door. Remember, always view and determine your door handing and swing from the **EXTERIOR** of your home.

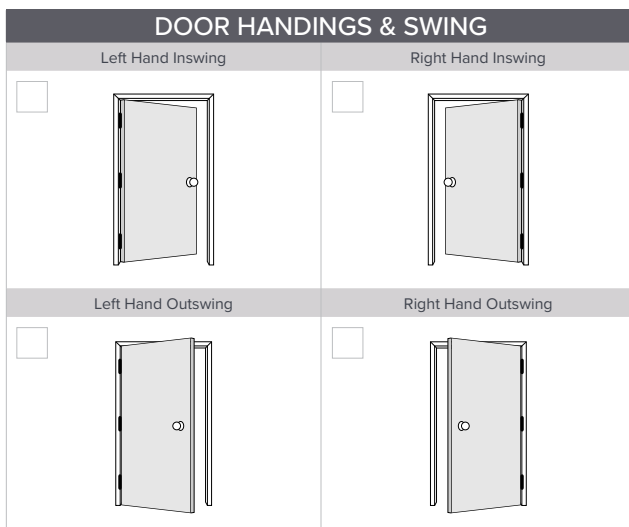

## STEP 5

### FINAL CALCULATIONS

After determining your existing door slab measurements from steps 1 & 2, record them in the first row below. Next, add the necessary measurement shown to determine the overall outside measurement (OSM) of your door frame.

WIDTH	HEIGHT	DEPTH
Slab width from Step 1:	Slab height from Step 2:	Jamb depth from Step 3:
<input type="text"/>	<input type="text"/>	<input type="text"/>
ADD: <b>1-3/4"</b>	ADD: <b>2-1/8"</b> for inswing doors or <b>2"</b> for outswing doors	
Overall door OSM width:	Overall door OSM height:	Overall door jamb depth:
<input type="text"/>	<input type="text"/>	<input type="text"/>

# DOOR PLANNER

## NOW LET'S MAKE IT HAPPEN

Now that you're inspired and have the confidence to create a door that perfectly compliments your style and personality, use the section below to sketch out and plan each of your dream doors. Once complete, simply bring in this page to an All Weather Windows sales representative or authorized dealer and we'll make it happen!

### ENTRY DOOR 1 *Location:* \_\_\_\_\_



*Slab Material:* \_\_\_\_\_  
*Glass Style:* \_\_\_\_\_  
*Frame Colour:* \_\_\_\_\_  
*Hardware Colour:* \_\_\_\_\_  
*Door Size:* \_\_\_\_\_

### ENTRY DOOR 2 *Location:* \_\_\_\_\_



*Slab Material:* \_\_\_\_\_  
*Glass Style:* \_\_\_\_\_  
*Frame Colour:* \_\_\_\_\_  
*Hardware Colour:* \_\_\_\_\_  
*Door Size:* \_\_\_\_\_

### ENTRY DOOR 3 *Location:* \_\_\_\_\_



*Slab Material:* \_\_\_\_\_  
*Glass Style:* \_\_\_\_\_  
*Frame Colour:* \_\_\_\_\_  
*Hardware Colour:* \_\_\_\_\_  
*Door Size:* \_\_\_\_\_

### DOUBLE/GARDEN DOOR *Location:* \_\_\_\_\_



*Slab Material:* \_\_\_\_\_  
*Glass Style:* \_\_\_\_\_  
*Frame Colour:* \_\_\_\_\_  
*Hardware Colour:* \_\_\_\_\_  
*Door Size:* \_\_\_\_\_











# DOOR LITE & PANEL LEGEND

## VISIBLE DOOR PANEL CODES

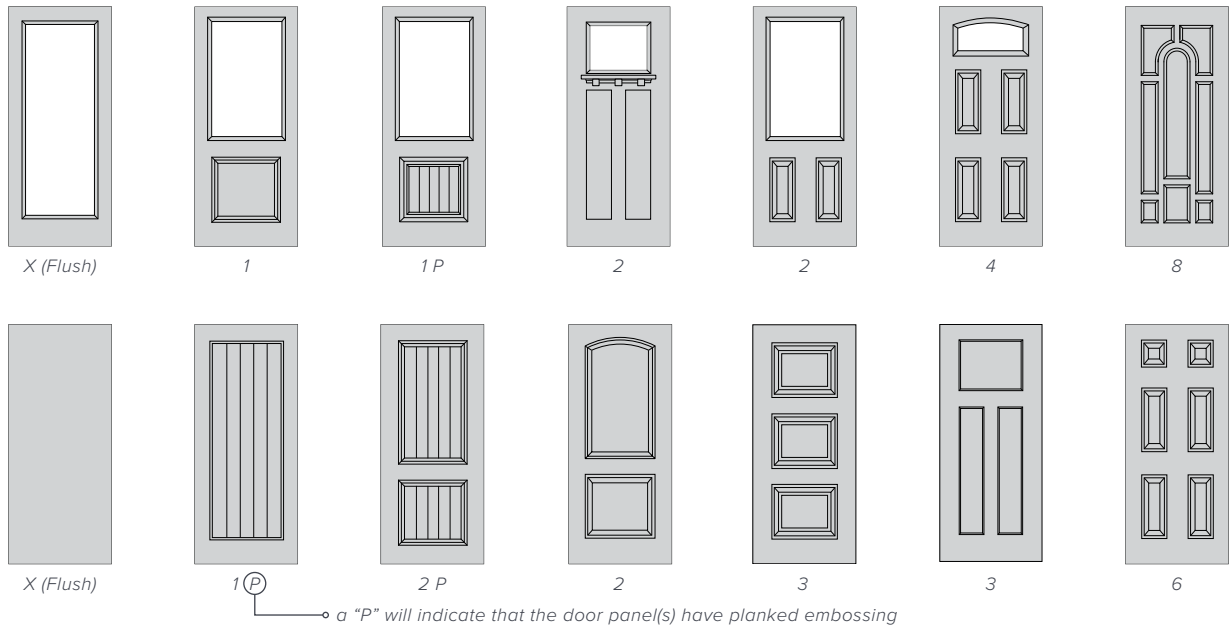

## DOOR LITE SHAPE & SIZE CODES

<b>104</b> 29" x 37" .....	Rectangle	<b>201</b> 8" x 58" .....	Round Top	<b>426</b> 26" x 48" .....	Rectangle
<b>106</b> 22" x 36" .....	Rectangle	<b>203</b> 8" x 42" .....	Round Top	<b>450</b> 8" x 48" .....	Rectangle
<b>107</b> 22" x 37-1/2" .....	Arch Top	<b>212</b> 22" x 8" .....	Rectangle	<b>451</b> 8" x 48" .....	Rectangle
<b>108</b> 20" x 20" .....	Square	<b>215</b> 22" x 16" .....	Rectangle	<b>610</b> 9" x 17" .....	Rectangle
<b>114</b> 14" x 64" .....	Rectangle	<b>217</b> 22" x 17" .....	Rectangle	<b>615</b> 8" x 16" .....	Rectangle
<b>120</b> 20" x 64" .....	Rectangle	<b>222</b> 22" x 12" .....	Rectangle	<b>617</b> 8" x 17" .....	Rectangle
<b>122</b> 22" x 64" .....	Rectangle	<b>223</b> 22" x 3-1/2" .....	Rectangle	<b>680</b> 8" x 6" .....	Rectangle
<b>126</b> 26" x 36" .....	Rectangle	<b>225</b> 22" x 15" .....	Rectangle	<b>682</b> 8" x 8" .....	Square
<b>129</b> 8" x 36" .....	Rectangle	<b>226</b> 22" x 17" .....	Rectangle	<b>806</b> 8" x 6" .....	Rectangle
<b>133</b> 22" x 9" .....	Rectangle	<b>228</b> 22" x 10" .....	Rectangle	<b>808</b> 8" x 8" .....	Square
<b>135</b> 22" x 10" .....	Sunburst	<b>251</b> 22" x 10" .....	Arch Top	<b>810</b> 22" x 80" .....	Rectangle
<b>136</b> 7-1/2" x 18-1/2" .....	Rectangle	<b>300</b> 20" x 57" .....	Oval	<b>814</b> 14" x 80" .....	Rectangle
<b>137</b> 22" x 10" .....	Arch Top	<b>302</b> 14" x 52" .....	Oval	<b>820</b> 20" x 80" .....	Rectangle
<b>151</b> 8" x 64" .....	Rectangle	<b>303</b> 16" x 40" .....	Oval	<b>826</b> 26" x 80" .....	Rectangle
<b>152</b> 7" x 64" .....	Rectangle	<b>304</b> 16" x 40" .....	Oval	<b>852</b> 8" x 80" .....	Rectangle
<b>153</b> 6-1/2" x 61-1/4" .....	Rectangle	<b>404</b> 22" x 48" .....	Rectangle	<b>853</b> 8" x 80" .....	Rectangle
<b>154</b> 7" x 64" .....	Rectangle	<b>405</b> 22" x 48" .....	Rectangle	<b>926</b> 26" x 64" .....	Rectangle
<b>155</b> 6" x 64" .....	Rectangle	<b>411</b> 22" x 37-1/2" .....	Arch Top		
<b>160</b> 20" x 36" .....	Rectangle	<b>420</b> 20" x 48" .....	Rectangle		

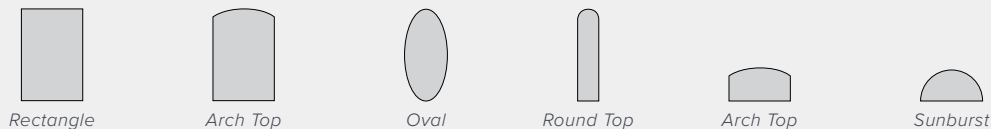

## A

Adelaide ADE (T) 45, 104  
 Alys (N) 46, 104  
 Arima (N) 47, 104  
 Astragal 94  
 Azur 338 (N) 48, 104

## B

Barrington Sierra 28  
 Bevel Patina 36, 116  
 Bolero (N) 41, 49, 104  
 Brickmould 102

## C

Cachet (N) 50, 104  
 Celeste 367 (N) 15, 51, 104  
 Chanelle 308 (N) 41, 52, 104  
 Chelsea® 341 (M) 53, 106  
 Cherry Grain 30  
 Chord® 115 (M) 35, 42, 54, 106, 118  
 Cladding 103  
 Clear Lites 35, 71, 86, 114, 116, 118  
 Colour 10, 103  
 Contemporary Cherry (T) 11, 30, 117, 119  
 Craftsman 4, 36, 119, 121  
 Cross Reed 71, 116  
 Crosswalk (O) 55, 106  
 Cruz™ 341 (M) 56, 106  
 Cuzco® 364 (M) 38, 57, 106

## D

Door Lite Size Codes 130  
 Double Doors 94

## E

Element® 328 (M) 39, 58, 106  
 ENERGY STAR® 98  
 Entropy (O) 59, 108  
 Entry Door System 99  
 Equation (N) 60, 106

## F

Fast-Frame® 96  
 Fir Texture 35, 39, 117, 118, 119  
 Fire Rated Door System 96  
 Fluid 079 (N) 10, 19, 61, 108  
 Flush 22, 23  
 Focus® 312 (M) 39, 62, 108  
 Frontier® 312 (M) 41, 63, 108

## G

Garden Doors 94  
 Georgian™ 515/517 (M) 64, 108  
 Grooved Lines 31

## H

Handings 95  
 Hardware 100, 102  
 Harlow (T) 65, 108  
 Hinges 102  
 Hollister HOL (T) 66, 108

## I

Internal Blinds (O) 35, 88  
 Internal Grille 101

## J

## K

Kordella® 686 (M) 39, 67, 110

## L

Lexington LEX (T) 68, 108  
 Linea (N) 19, 117, 121  
 Louisbourg (N) 69, 110

## M

Mahogany Texture 28, 31, 38, 39, 119  
 Marco® 331 (M) 70, 110  
 Measuring Your Door 124  
 Mid-Century Modern (T) 20, 71, 116  
 Mistify (O) 72, 110  
 Mistral (N) 73, 110  
 Modena MOD (T) 74, 110  
 Modern Doors 6  
 Monterey (O) 75, 110  
 Multilock Hardware 100

## N

NAFS 98, 99  
 Naples® 366 (M) 4, 76, 112  
 Narrow Reed 71, 116  
 Nuando (N) 77, 110

## O

Oak Texture 39, 117, 120  
 Obscure 86  
 Opal 349 (N) 14, 78, 112  
 Opaque 10, 14, 86  
 Operating Styles 94  
 OSO (T) 17, 117, 121

## P

Panama® 724/725 (M) 79, 112  
 Panels 117  
 Pear 116 (M) 19, 34, 35, 80, 112, 116, 118  
 Pearl® 140 (M) 14, 35, 81, 112, 118  
 Pre-Painted/Stained 10, 103  
 Pure 334 (N) 82, 112

## Q

## R

Rain 86  
 Rough Openings 122  
 Royston (T) 83, 112  
 Rozet® 467 (M) 84, 114  
 Rustic (T) 32, 117, 120

## S

Sable (T) 71, 116  
 Sand Blasted (T) 71, 116  
 SDL 35, 37, 101, 116, 118  
 Sea Spray (T) 20, 71, 116  
 Shaker Doors 8, 117, 119, 120  
 Sidelites 94  
 Sierra 28  
 Sizing 119  
 Slab Sizing 119  
 Smooth Fibreglass 34, 36, 40, 119, 120  
 Soft 079 (N) 12, 85, 112  
 SOHO (T) 18, 117, 121  
 Stained Doors (Pre-Stained) 10, 103  
 Stainless Steel Bars 31  
 Steel 12, 42, 117, 121  
 Steel Adjustable Fast-Frame® 96  
 Striker Plates 102  
 Swing 95

## T

Textured Fibreglass 38  
 Textured Glass 86, 114  
 Transit 263 (N) 87, 114  
 Transoms 94

## U

## V

Venting Lites (O) 88, 114  
 Verso (N) 89, 114  
 VistaGrande™ (M) 4, 7, 34, 118, 121  
 VOG (T) 1, 16, 43, 117, 121

## W

Winchester (N) 90, 114

## X

## Y

## Z

Zenith 347 (N) 13, 91, 114



# inspire create

allweatherwindows.com  WEB

allweatherwindowscanada  FACEBOOK

awwcanada  INSTAGRAM

@AWWCanada  X

All Weather Windows  LINKEDIN

TOLL-FREE CANADA 800.638.5709

CALGARY 888.932.3387

EDMONTON 800.232.9407

LETHBRIDGE 877.327.0701

RED DEER 855.348.0701

REGINA 888.672.2202

SASKATOON 800.589.9899

VANCOUVER 800.518.8338

WINNIPEG 800.892.5340



Platinum member



While All Weather Windows makes every effort to ensure that the information contained in this catalogue is accurate, we do not accept liability for any inaccuracies. This catalogue is subject to change, as well as errors and omissions, without notice or liability. Doors are provided unfinished/unstained and without hardware unless otherwise noted. All photos are for illustration purposes only and depicted door frames and windows may not represent All Weather Windows products. All Weather Windows® is a trademark of All Weather Windows Ltd.

V3.8 002020.04.23.24 Printed locally in Edmonton, AB, Canada 2024